



# NX1029X

60 / 50 V, 330 / 170 mA N/P-channel Trench MOSFET

Rev. 1 — 12 August 2011

Product data sheet

## 1. Product profile

### 1.1 General description

Complementary N/P-channel enhancement mode Field-Effect Transistor (FET) in an ultra small and flat lead SOT666 Surface-Mounted Device (SMD) plastic package using Trench MOSFET technology.

### 1.2 Features and benefits

- Logic-level compatible
- Very fast switching
- Trench MOSFET technology
- ESD protection up to 2 kV (N-channel) and 1 kV (P-channel)
- AEC-Q101 qualified

### 1.3 Applications

- Level shifter
- Power supply converter
- Load switch
- Switching circuits

### 1.4 Quick reference data

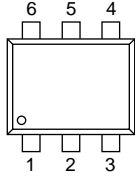
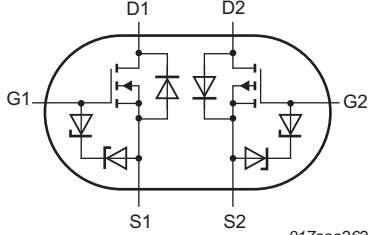
Table 1. Quick reference data

Symbol	Parameter	Conditions	Min	Typ	Max	Unit
<b>TR2 (P-channel)</b>						
$V_{DS}$	drain-source voltage	$T_j = 25\text{ °C}$	-	-	-50	V
$V_{GS}$	gate-source voltage		-20	-	20	V
$I_D$	drain current	$V_{GS} = -10\text{ V}; T_{amb} = 25\text{ °C}$	[1]	-	-170	mA
<b>TR1 (N-channel)</b>						
$V_{DS}$	drain-source voltage	$T_j = 25\text{ °C}$	-	-	60	V
$V_{GS}$	gate-source voltage		-20	-	20	V
$I_D$	drain current	$V_{GS} = 10\text{ V}; T_{amb} = 25\text{ °C}$	[1]	-	330	mA
<b>TR1 (N-channel), Static characteristics</b>						
$R_{DSon}$	drain-source on-state resistance	$V_{GS} = 10\text{ V}; I_D = 500\text{ mA};$ pulsed; $t_p \leq 300\text{ }\mu\text{s};$ $\delta \leq 0.01$ ; $T_j = 25\text{ °C}$	-	1	1.6	$\Omega$
<b>TR2 (P-channel), Static characteristics</b>						
$R_{DSon}$	drain-source on-state resistance	$V_{GS} = -10\text{ V}; I_D = -100\text{ mA};$ $T_j = 25\text{ °C}$	-	4.5	7.5	$\Omega$

[1] Device mounted on an FR4 PCB, single-sided copper, tin-plated and mounting pad for drain 1 cm<sup>2</sup>.

## 2. Pinning information

Table 2. Pinning information

Pin	Symbol	Description	Simplified outline	Graphic symbol
1	S1	source TR1	 <p>SOT666 (SOT666)</p>	 <p>017aaa262</p>
2	G1	gate TR1		
3	D2	drain TR2		
4	S2	source TR2		
5	G2	gate TR2		
6	D1	drain TR1		

## 3. Ordering information

Table 3. Ordering information

Type number	Package		Version
	Name	Description	
NX1029X	SOT666	plastic surface-mounted package; 6 leads	SOT666

## 4. Marking

Table 4. Marking codes

Type number	Marking code <sup>[1]</sup>
NX1029X	AD

[1] % = placeholder for manufacturing site code.

## 5. Limiting values

**Table 5. Limiting values**

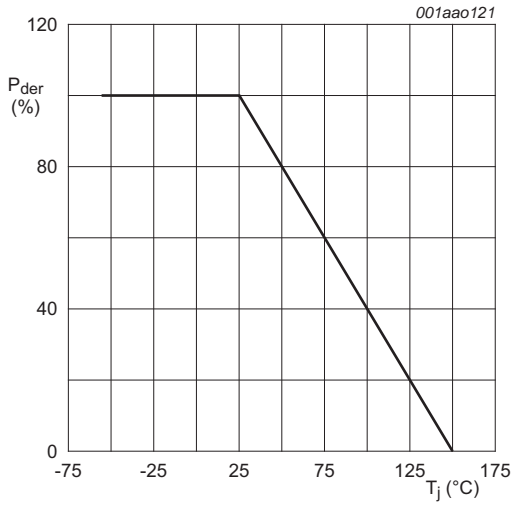
In accordance with the Absolute Maximum Rating System (IEC 60134).

Symbol	Parameter	Conditions	Min	Max	Unit	
<b>TR2 (P-channel)</b>						
$V_{DS}$	drain-source voltage	$T_j = 25\text{ °C}$	-	-50	V	
$V_{GS}$	gate-source voltage		-20	20	V	
$I_D$	drain current	$V_{GS} = -10\text{ V}; T_{amb} = 25\text{ °C}$	[1]	-	-170	mA
		$V_{GS} = -10\text{ V}; T_{amb} = 100\text{ °C}$	[1]	-	-110	mA
$I_{DM}$	peak drain current	$T_{amb} = 25\text{ °C};$ single pulse; $t_p \leq 10\text{ }\mu\text{s}$	-	-0.7	A	
$P_{tot}$	total power dissipation	$T_{amb} = 25\text{ °C}$	[2]	-	330	mW
			[1]	-	390	mW
		$T_{sp} = 25\text{ °C}$	-	-	1090	mW
<b>TR1 (N-channel)</b>						
$V_{DS}$	drain-source voltage	$T_j = 25\text{ °C}$	-	60	V	
$V_{GS}$	gate-source voltage		-20	20	V	
$I_D$	drain current	$V_{GS} = 10\text{ V}; T_{amb} = 25\text{ °C}$	[1]	-	330	mA
		$V_{GS} = 10\text{ V}; T_{amb} = 100\text{ °C}$	[1]	-	210	mA
$I_{DM}$	peak drain current	$T_{amb} = 25\text{ °C};$ single pulse; $t_p \leq 10\text{ }\mu\text{s}$	-	1.2	A	
$P_{tot}$	total power dissipation	$T_{amb} = 25\text{ °C}$	[2]	-	330	mW
			[1]	-	390	mW
		$T_{sp} = 25\text{ °C}$	-	-	1090	mW
<b>Per device</b>						
$P_{tot}$	total power dissipation	$T_{amb} = 25\text{ °C}$	[2]	-	500	mW
$T_j$	junction temperature		-55	150	°C	
$T_{amb}$	ambient temperature		-55	150	°C	
$T_{stg}$	storage temperature		-65	150	°C	
<b>TR1 (N-channel), Source-drain diode</b>						
$I_S$	source current	$T_{amb} = 25\text{ °C}$	[2][1]	-	330	mA
<b>TR2 (P-channel), Source-drain diode</b>						
$I_S$	source current	$T_{amb} = 25\text{ °C}$	[1]	-	-170	mA
<b>TR1 N-channel), ESD maximum rating</b>						
$V_{ESD}$	electrostatic discharge voltage	HBM	[3]	-	2000	V
<b>TR2 (P-channel), ESD maximum rating</b>						
$V_{ESD}$	electrostatic discharge voltage	HBM	[3]	-	1000	V

[1] Device mounted on an FR4 PCB, single-sided copper, tin-plated and mounting pad for drain 1 cm<sup>2</sup>.

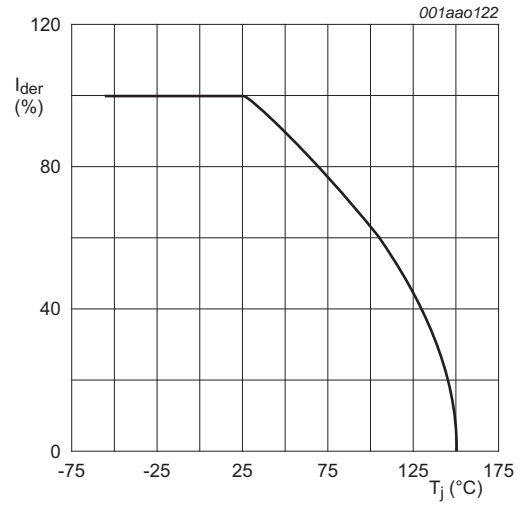
[2] Device mounted on an FR4 Printed-Circuit Board (PCB), single-sided copper; tin-plated and standard footprint.

[3] Measured between all pins.



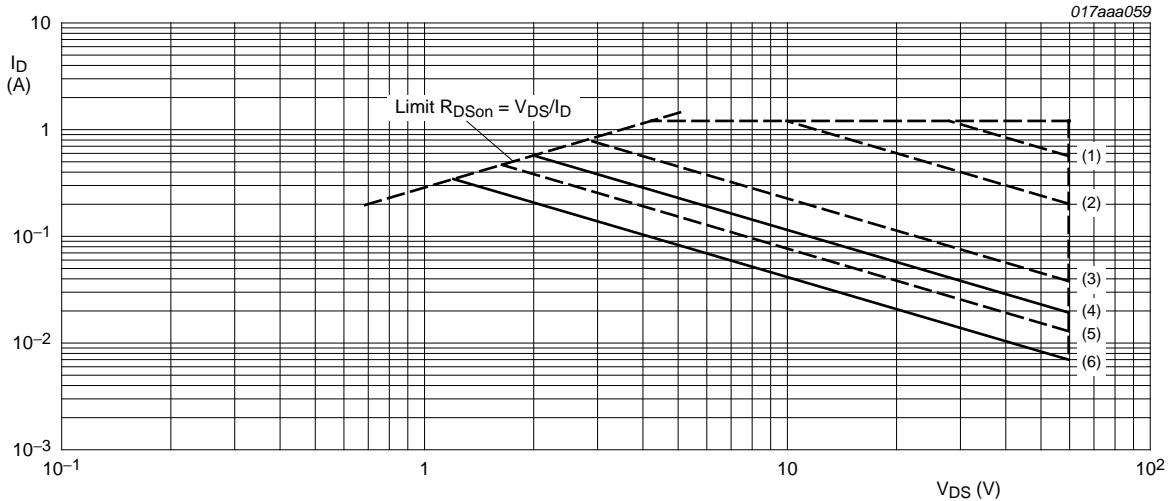
$$P_{der} = \frac{P_{tot}}{P_{tot(25^\circ\text{C})}} \times 100\%$$

Fig 1. Normalized total power dissipation as a function of junction temperature



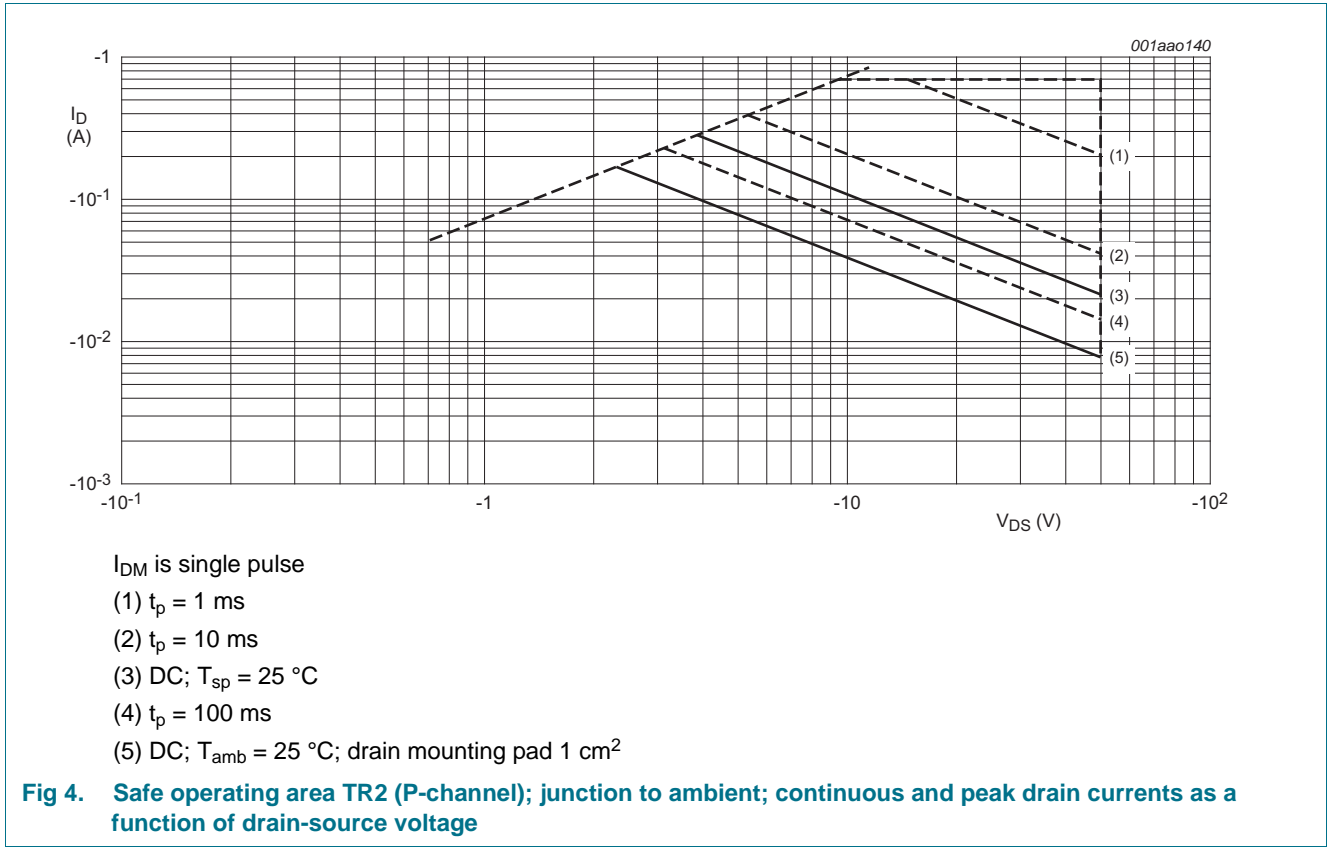
$$I_{der} = \frac{I_D}{I_{D(25^\circ\text{C})}} \times 100\%$$

Fig 2. Normalized continuous drain current as a function of junction temperature



- $I_{DM}$  = single pulse
- (1)  $t_p = 100 \mu\text{s}$
  - (2)  $t_p = 1 \text{ ms}$
  - (3)  $t_p = 10 \text{ ms}$
  - (4) DC;  $T_{sp} = 25^\circ\text{C}$
  - (5)  $t_p = 100 \text{ ms}$
  - (6) DC;  $T_{amb} = 25^\circ\text{C}$ ; drain mounting pad  $1 \text{ cm}^2$

Fig 3. Safe operating area TR1 (N-channel); junction to ambient; continuous and peak drain currents as a function of drain-source voltage



## 6. Thermal characteristics

**Table 6. Thermal characteristics**

Symbol	Parameter	Conditions	Min	Typ	Max	Unit
<b>Per device</b>						
$R_{th(j-a)}$	thermal resistance from junction to ambient	in free air	[1]	-	250	K/W
<b>TR1 (N-channel)</b>						
$R_{th(j-a)}$	thermal resistance from junction to ambient	in free air	[1]	330	380	K/W
			[2]	280	320	K/W
$R_{th(j-sp)}$	thermal resistance from junction to solder point		-	-	115	K/W
<b>TR2 (P-channel)</b>						
$R_{th(j-a)}$	thermal resistance from junction to ambient	in free air	[1]	330	380	K/W
			[2]	280	320	K/W
$R_{th(j-sp)}$	thermal resistance from junction to solder point		-	-	115	K/W

[1] Device mounted on an FR4 Printed-Circuit Board (PCB), single-sided copper; tin-plated and standard footprint.

[2] Device mounted on an FR4 PCB, single-sided copper, tin-plated and mounting pad for drain  $1$  cm<sup>2</sup>.

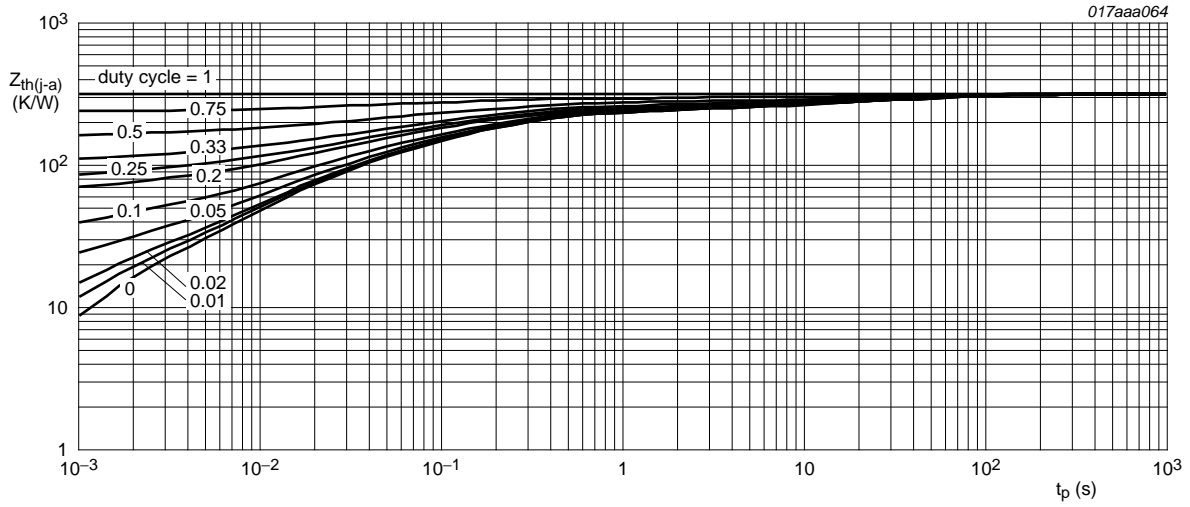


Fig 5. TR1: Transient thermal impedance from junction to ambient as a function of pulse duration; typical values

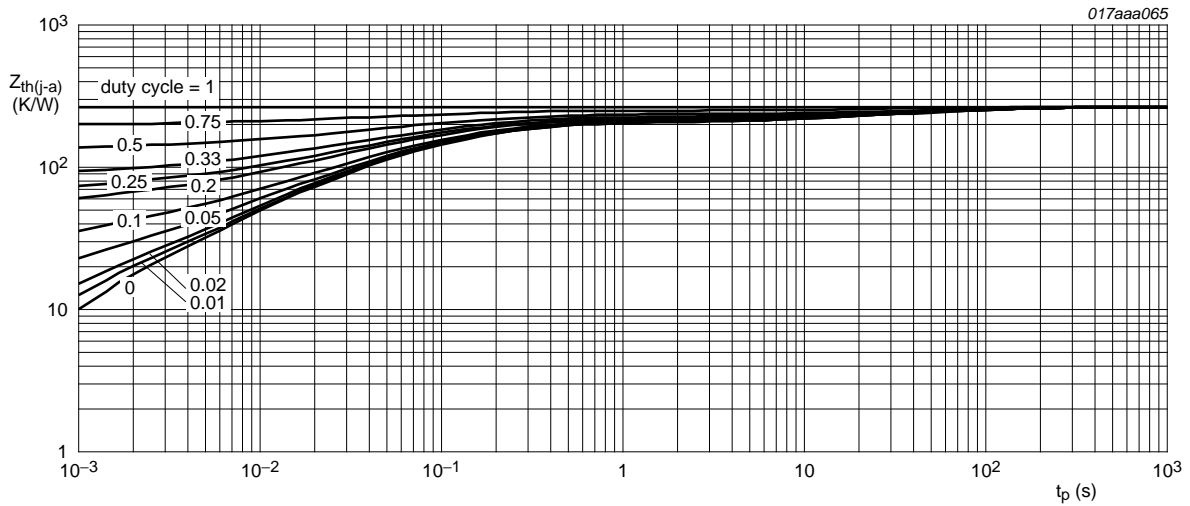


Fig 6. TR1: Transient thermal impedance from junction to ambient as a function of pulse duration; typical values

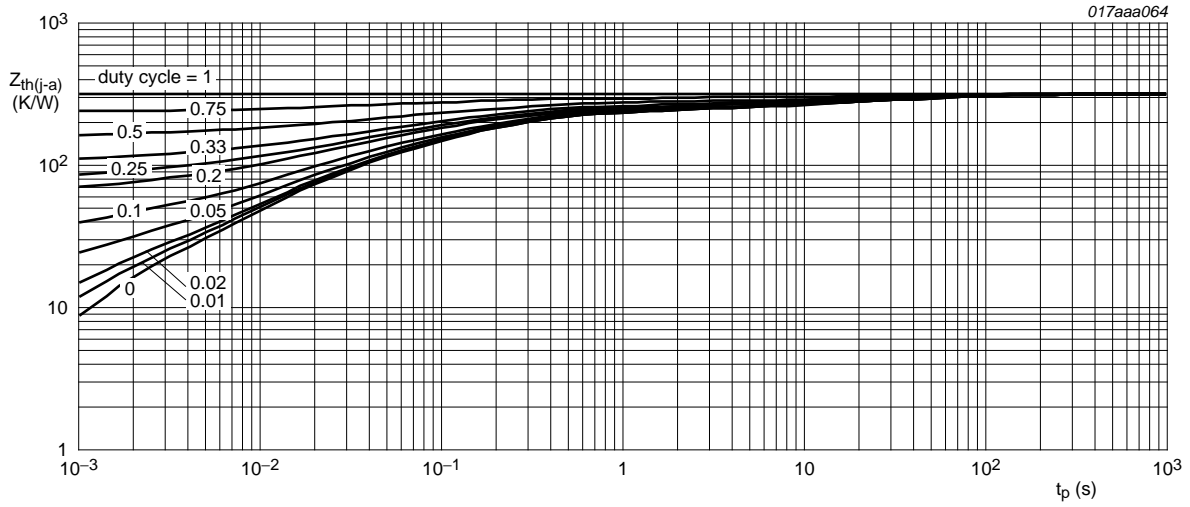


Fig 7. TR2: Transient thermal impedance from junction to ambient as a function of pulse duration; typical values

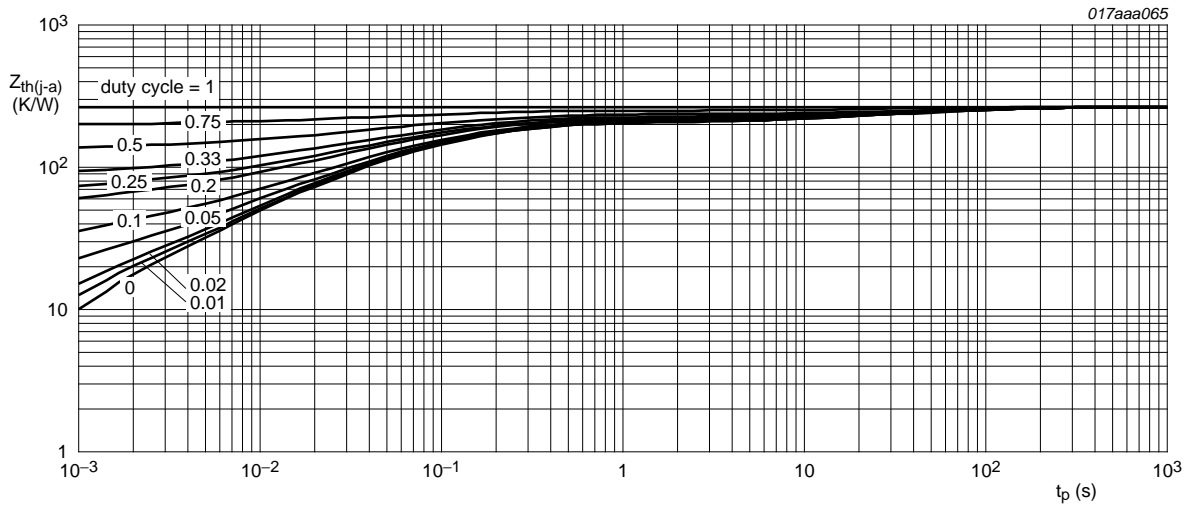


Fig 8. TR2: Transient thermal impedance from junction to ambient as a function of pulse duration; typical values

## 7. Characteristics

Table 7. Characteristics

Symbol	Parameter	Conditions	Min	Typ	Max	Unit
<b>TR2 (P-channel), Static characteristics</b>						
$V_{(BR)DSS}$	drain-source breakdown voltage	$I_D = -10 \mu\text{A}$ ; $V_{GS} = 0 \text{ V}$ ; $T_j = 25 \text{ }^\circ\text{C}$	-50	-	-	V
$V_{GSth}$	gate-source threshold voltage	$I_D = -250 \mu\text{A}$ ; $V_{DS} = V_{GS}$ ; $T_j = 25 \text{ }^\circ\text{C}$	-1.1	-1.6	-2.1	V
$I_{DSS}$	drain leakage current	$V_{DS} = -50 \text{ V}$ ; $V_{GS} = 0 \text{ V}$ ; $T_j = 25 \text{ }^\circ\text{C}$	-	-	-1	$\mu\text{A}$
		$V_{DS} = -50 \text{ V}$ ; $V_{GS} = 0 \text{ V}$ ; $T_j = 150 \text{ }^\circ\text{C}$	-	-	-2	$\mu\text{A}$
$I_{GSS}$	gate leakage current	$V_{GS} = 20 \text{ V}$ ; $V_{DS} = 0 \text{ V}$ ; $T_j = 25 \text{ }^\circ\text{C}$	-	-	-10	$\mu\text{A}$
		$V_{GS} = -20 \text{ V}$ ; $V_{DS} = 0 \text{ V}$ ; $T_j = 25 \text{ }^\circ\text{C}$	-	-	-10	$\mu\text{A}$
$R_{DSon}$	drain-source on-state resistance	$V_{GS} = -10 \text{ V}$ ; $I_D = -100 \text{ mA}$ ; $T_j = 25 \text{ }^\circ\text{C}$	-	4.5	7.5	$\Omega$
		$V_{GS} = -10 \text{ V}$ ; $I_D = -100 \text{ mA}$ ; $T_j = 150 \text{ }^\circ\text{C}$	-	8	13.5	$\Omega$
		$V_{GS} = -5 \text{ V}$ ; $I_D = -100 \text{ mA}$ ; $T_j = 25 \text{ }^\circ\text{C}$	-	5.1	8.5	$\Omega$
$g_{fs}$	transfer conductance	$V_{DS} = -10 \text{ V}$ ; $I_D = -100 \text{ mA}$ ; $T_j = 25 \text{ }^\circ\text{C}$	-	150	-	mS
<b>TR1 (N-channel), Static characteristics</b>						
$V_{(BR)DSS}$	drain-source breakdown voltage	$I_D = 10 \mu\text{A}$ ; $V_{GS} = 0 \text{ V}$ ; $T_j = 25 \text{ }^\circ\text{C}$	60	-	-	V
$V_{GSth}$	gate-source threshold voltage	$I_D = 250 \mu\text{A}$ ; $V_{DS} = V_{GS}$ ; $T_j = 25 \text{ }^\circ\text{C}$	1.1	1.6	2.1	V
$I_{DSS}$	drain leakage current	$V_{DS} = 60 \text{ V}$ ; $V_{GS} = 0 \text{ V}$ ; $T_j = 25 \text{ }^\circ\text{C}$	-	-	1	$\mu\text{A}$
		$V_{DS} = 60 \text{ V}$ ; $V_{GS} = 0 \text{ V}$ ; $T_j = 150 \text{ }^\circ\text{C}$	-	-	10	$\mu\text{A}$
$I_{GSS}$	gate leakage current	$V_{GS} = 20 \text{ V}$ ; $V_{DS} = 0 \text{ V}$ ; $T_j = 25 \text{ }^\circ\text{C}$	-	-	10	$\mu\text{A}$
		$V_{GS} = -20 \text{ V}$ ; $V_{DS} = 0 \text{ V}$ ; $T_j = 25 \text{ }^\circ\text{C}$	-	-	10	$\mu\text{A}$
$R_{DSon}$	drain-source on-state resistance	$V_{GS} = 10 \text{ V}$ ; $I_D = 500 \text{ mA}$ ; pulsed; $t_p \leq 300 \mu\text{s}$ ; $\delta \leq 0.01$ ; $T_j = 25 \text{ }^\circ\text{C}$	-	1	1.6	$\Omega$
		$V_{GS} = 10 \text{ V}$ ; $I_D = 500 \text{ mA}$ ; pulsed; $t_p \leq 300 \mu\text{s}$ ; $\delta \leq 0.01$ ; $T_j = 150 \text{ }^\circ\text{C}$	-	2.25	3.6	$\Omega$
		$V_{GS} = 5 \text{ V}$ ; $I_D = 50 \text{ mA}$ ; pulsed; $t_p \leq 300 \mu\text{s}$ ; $\delta \leq 0.01$ ; $T_j = 25 \text{ }^\circ\text{C}$	-	1.3	2	$\Omega$
$g_{fs}$	transfer conductance	$V_{DS} = 10 \text{ V}$ ; $I_D = 100 \text{ mA}$ ; $T_j = 25 \text{ }^\circ\text{C}$	-	550	-	mS
<b>TR2 (P-channel), Dynamic characteristics</b>						
$Q_{G(tot)}$	total gate charge	$V_{DS} = -25 \text{ V}$ ; $I_D = -180 \text{ mA}$ ; $V_{GS} = -5 \text{ V}$ ; $T_j = 25 \text{ }^\circ\text{C}$	-	0.26	0.35	nC
$Q_{GS}$	gate-source charge		-	0.12	-	nC
$Q_{GD}$	gate-drain charge		-	0.09	-	nC
$C_{iss}$	input capacitance	$V_{DS} = -25 \text{ V}$ ; $f = 1 \text{ MHz}$ ; $V_{GS} = 0 \text{ V}$ ; $T_j = 25 \text{ }^\circ\text{C}$	-	24	36	pF
$C_{oss}$	output capacitance		-	4.5	-	pF
$C_{rss}$	reverse transfer capacitance		-	1.3	-	pF
$t_{d(on)}$	turn-on delay time	$V_{DS} = -30 \text{ V}$ ; $R_L = 250 \Omega$ ; $V_{GS} = -10 \text{ V}$ ; $R_{G(ext)} = 6 \Omega$ ; $T_j = 25 \text{ }^\circ\text{C}$	-	13	26	ns
$t_r$	rise time		-	11	-	ns
$t_{d(off)}$	turn-off delay time		-	48	96	ns
$t_f$	fall time		-	25	-	ns



Table 7. Characteristics ...continued

Symbol	Parameter	Conditions	Min	Typ	Max	Unit
<b>TR1 (N-channel), Dynamic characteristics</b>						
$Q_{G(tot)}$	total gate charge	$V_{DS} = 30\text{ V}; I_D = 300\text{ mA}; V_{GS} = 4.5\text{ V}; T_j = 25\text{ }^\circ\text{C}$	-	0.5	0.6	nC
$Q_{GS}$	gate-source charge		-	0.2	-	nC
$Q_{GD}$	gate-drain charge		-	0.1	-	nC
$C_{iss}$	input capacitance	$V_{DS} = 10\text{ V}; f = 1\text{ MHz}; V_{GS} = 0\text{ V}; T_j = 25\text{ }^\circ\text{C}$	-	33	50	pF
$C_{oss}$	output capacitance		-	7	-	pF
$C_{rss}$	reverse transfer capacitance		-	4	-	pF
$t_{d(on)}$	turn-on delay time	$V_{DS} = 50\text{ V}; R_L = 250\text{ }\Omega; V_{GS} = 10\text{ V}; R_{G(ext)} = 6\text{ }\Omega; T_j = 25\text{ }^\circ\text{C}$	-	5	10	ns
$t_r$	rise time		-	6	-	ns
$t_{d(off)}$	turn-off delay time		-	12	24	ns
$t_f$	fall time		-	7	-	ns
<b>TR2 (P-channel), Source-drain diode characteristics</b>						
$V_{SD}$	source-drain voltage	$I_S = -115\text{ mA}; V_{GS} = 0\text{ V}; T_j = 25\text{ }^\circ\text{C}$	-0.48	-0.85	-1.2	V
<b>TR1 (N-channel), Source-drain diode characteristics</b>						
$V_{SD}$	source-drain voltage	$I_S = 115\text{ mA}; V_{GS} = 0\text{ V}; T_j = 25\text{ }^\circ\text{C}$	0.47	0.75	1.1	V

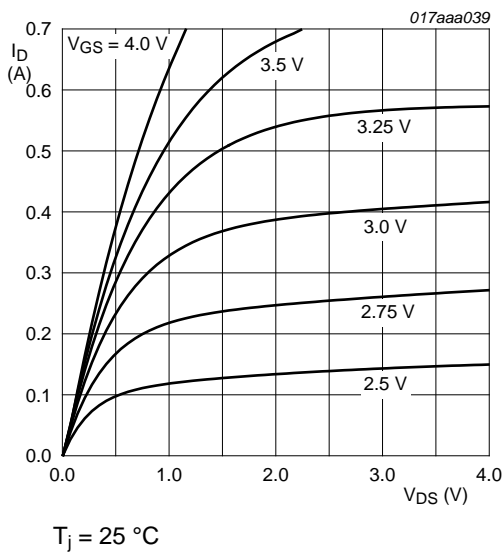


Fig 9. TR1: Output characteristics: drain current as a function of drain-source voltage; typical values

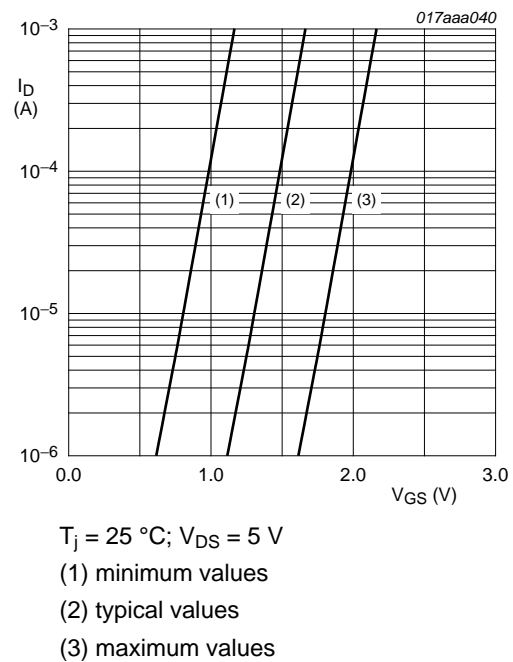
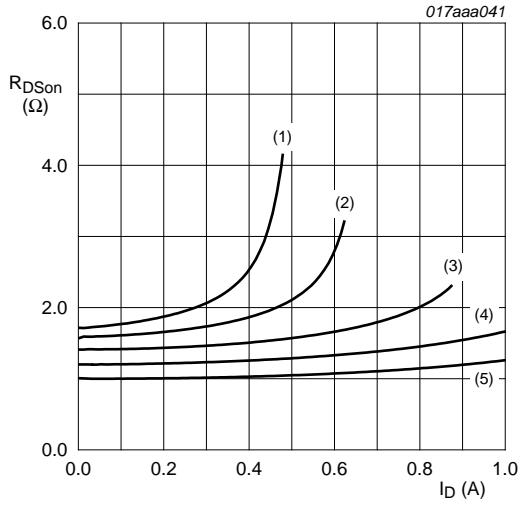
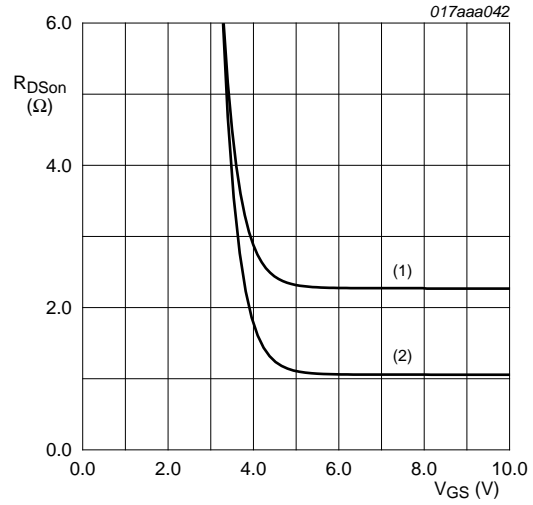


Fig 10. TR1: Sub-threshold drain current as a function of gate-source voltage



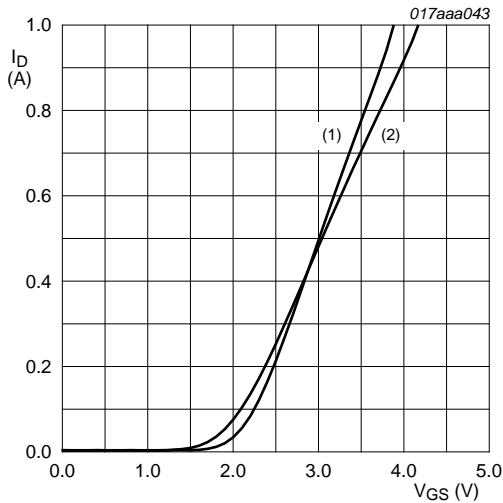
$T_j = 25\text{ }^\circ\text{C}$   
 (1)  $V_{GS} = 3.25\text{ V}$   
 (2)  $V_{GS} = 3.5\text{ V}$   
 (3)  $V_{GS} = 4\text{ V}$   
 (4)  $V_{GS} = 5\text{ V}$   
 (5)  $V_{GS} = 10\text{ V}$

**Fig 11. TR1: Drain-source on-state resistance as a function of drain current; typical values**



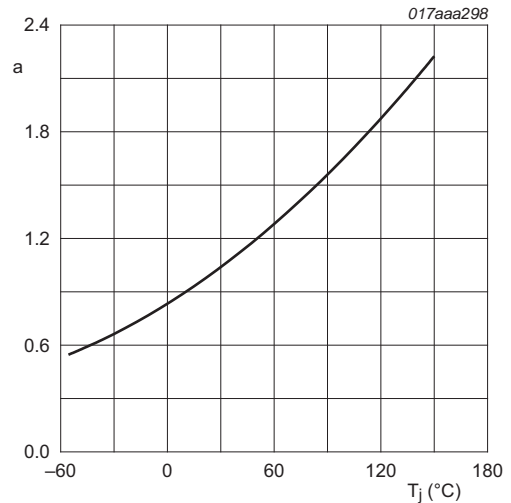
$I_D = 500\text{ mA}$ ; pulsed;  $t_p \leq 300\text{ }\mu\text{s}$ ;  $\delta \leq 0.01$   
 (1)  $T_j = 150\text{ }^\circ\text{C}$   
 (2)  $T_j = 25\text{ }^\circ\text{C}$

**Fig 12. TR1: Drain-source on-state resistance as a function of gate-source voltage; typical values**



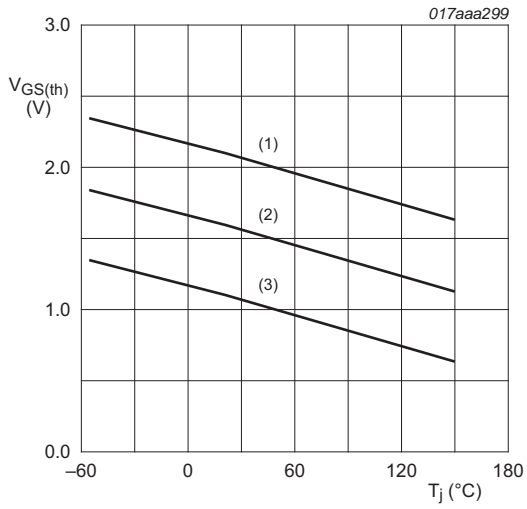
$V_{DS} > I_D \times R_{DS(on)}$   
 (1)  $T_j = 25\text{ }^\circ\text{C}$   
 (2)  $T_j = 150\text{ }^\circ\text{C}$

**Fig 13. TR1: Transfer characteristics: drain current as a function of gate-source voltage; typical values**



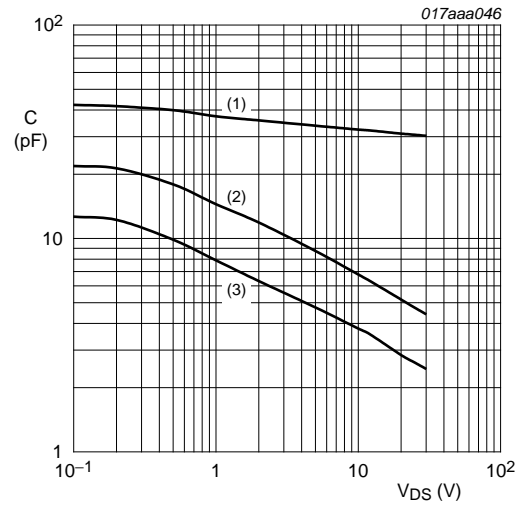
$$a = \frac{R_{DS(on)}}{R_{DS(on)(25^\circ\text{C})}}$$

**Fig 14. TR1: Normalized drain-source on-state resistance as a function of junction temperature; typical values**



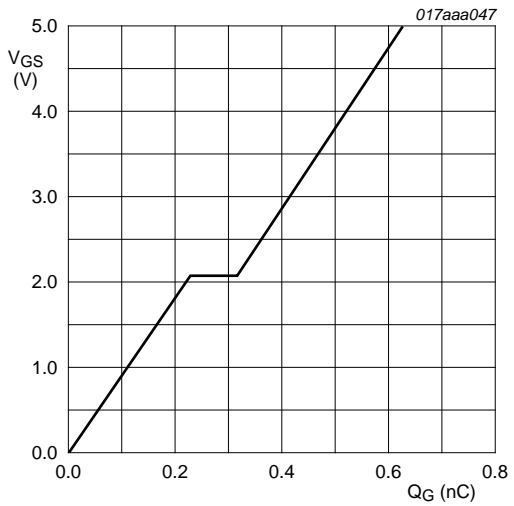
$I_D = 0.25 \text{ mA}; V_{DS} = V_{GS}$   
 (1) maximum values  
 (2) typical values  
 (3) minimum values

**Fig 15. TR1: Gate-source threshold voltage as a function of junction temperature**



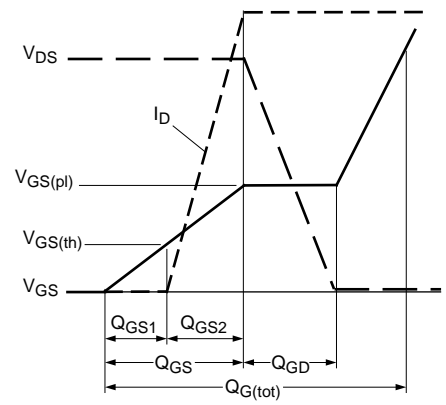
$f = 1 \text{ MHz}; V_{GS} = 0 \text{ V}$   
 (1)  $C_{iss}$   
 (2)  $C_{oss}$   
 (3)  $C_{rss}$

**Fig 16. TR1: Input, output and reverse transfer capacitances as a function of drain-source voltage; typical values**

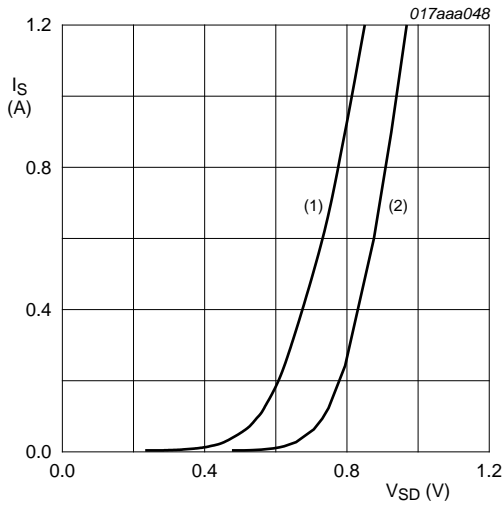


$I_D = 300 \text{ mA}; V_{DS} = 30 \text{ V}; T_{amb} = 25 \text{ °C}$

**Fig 17. TR1: Gate-source voltage as a function of gate charge; typical values**

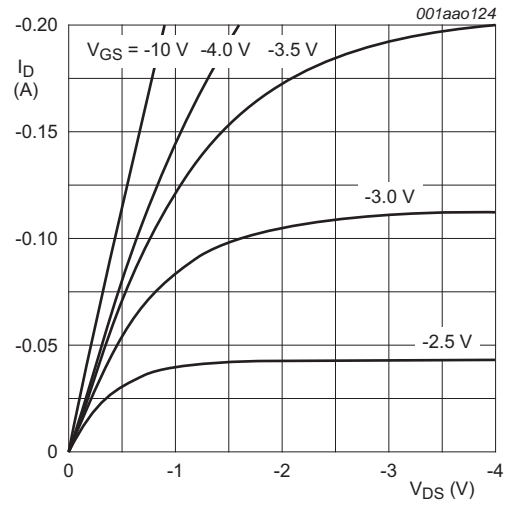


**Fig 18. Gate charge waveform definitions**



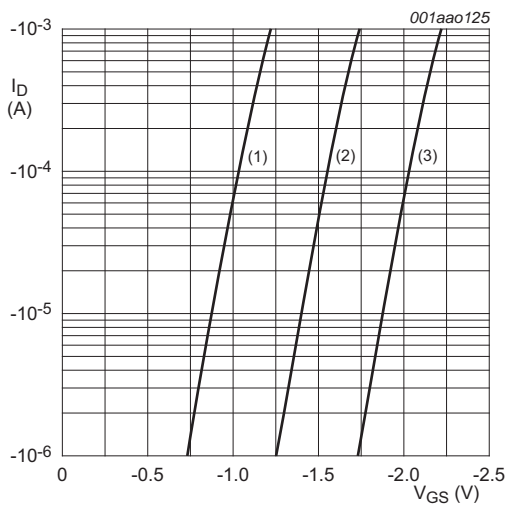
$V_{GS} = 0\text{ V}$   
 (1)  $T_j = 150\text{ °C}$   
 (2)  $T_j = 25\text{ °C}$

**Fig 19. TR1: Source current as a function of source-drain voltage; typical values**



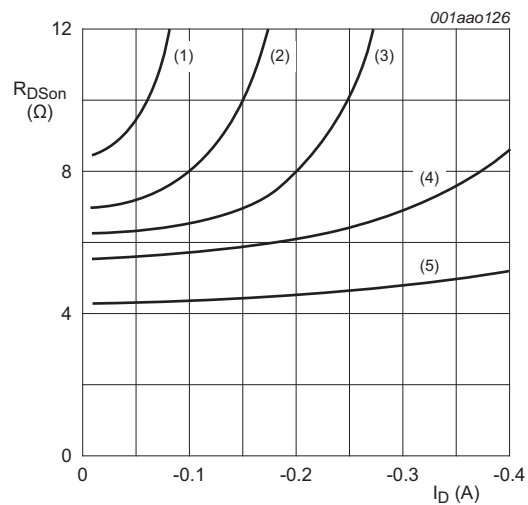
$T_j = 25\text{ °C}$

**Fig 20. TR2: Output characteristics: drain current as a function of drain-source voltage; typical values**



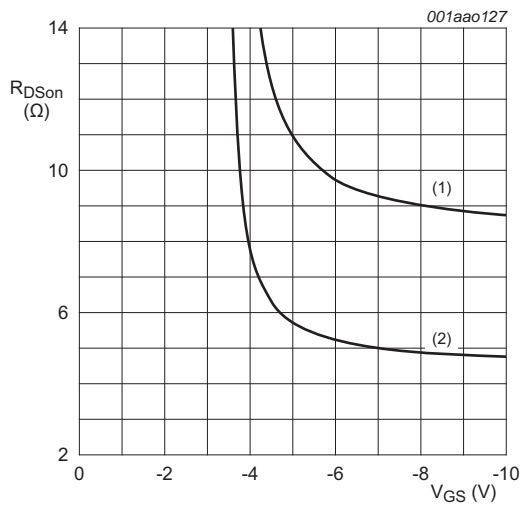
$T_j = 25\text{ °C}; V_{DS} = -5\text{ V}$   
 (1) minimum values  
 (2) typical values  
 (3) maximum values

**Fig 21. TR2: Sub-threshold drain current as a function of gate-source voltage**



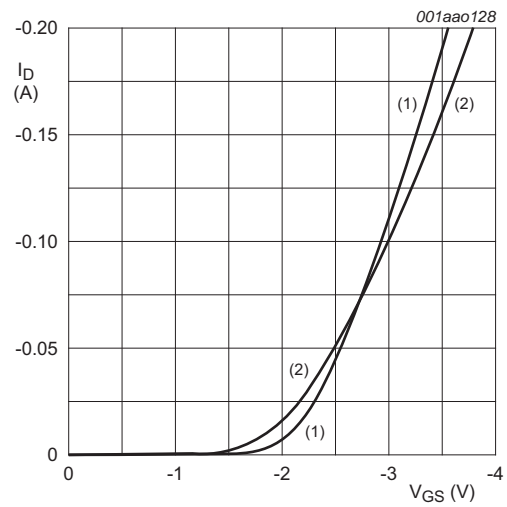
$T_j = 25\text{ °C}$   
 (1)  $V_{GS} = -3.0\text{ V}$   
 (2)  $V_{GS} = -3.5\text{ V}$   
 (3)  $V_{GS} = -4.0\text{ V}$   
 (4)  $V_{GS} = -5.0\text{ V}$   
 (5)  $V_{GS} = -10.0\text{ V}$

**Fig 22. TR2: Drain-source on-state resistance as a function of drain current; typical values**



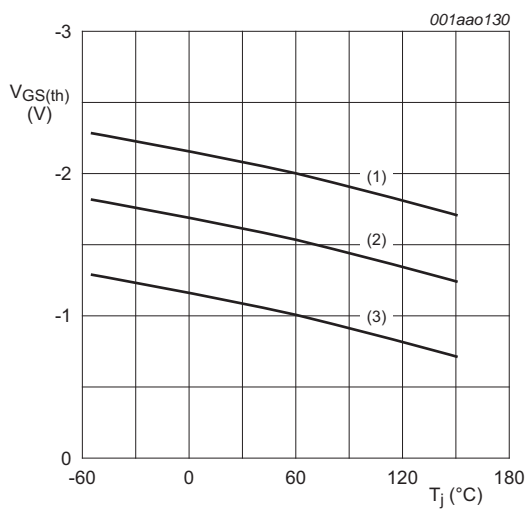
$I_D = -200 \text{ mA}$   
 (1)  $T_j = 150 \text{ }^\circ\text{C}$   
 (2)  $T_j = 25 \text{ }^\circ\text{C}$

**Fig 23. TR2: Drain-source on-state resistance as a function of gate-source voltage; typical values**



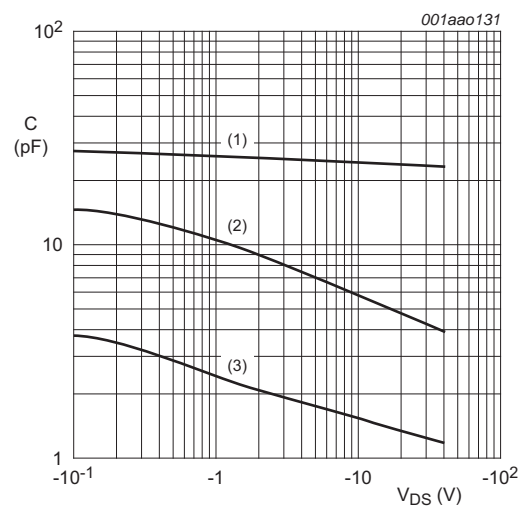
$V_{DS} > I_D \times R_{DS(on)}$   
 (1)  $T_j = 25 \text{ }^\circ\text{C}$   
 (2)  $T_j = 150 \text{ }^\circ\text{C}$

**Fig 24. TR2: Transfer characteristics: drain current as a function of gate-source voltage; typical values**



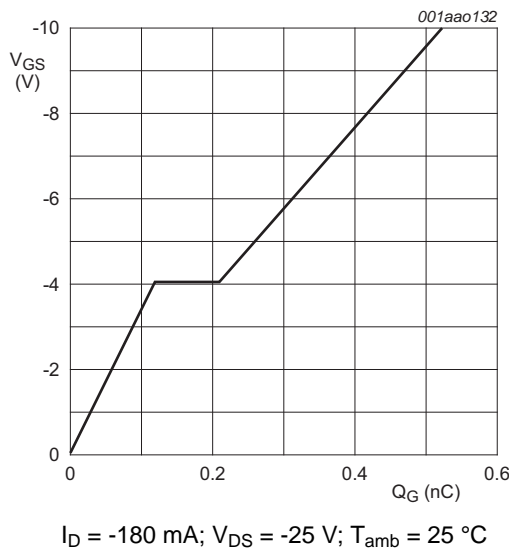
$I_D = -0.25 \text{ mA}; V_{DS} = V_{GS}$   
 (1) maximum values  
 (2) typical values  
 (3) minimum values

**Fig 25. TR2: Gate-source threshold voltage as a function of junction temperature**



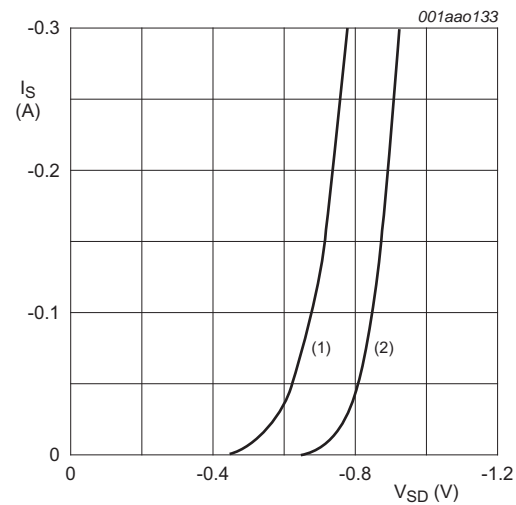
$f = 1 \text{ MHz}; V_{GS} = 0 \text{ V}$   
 (1)  $C_{iss}$   
 (2)  $C_{oss}$   
 (3)  $C_{rss}$

**Fig 26. TR2: Input, output and reverse transfer capacitances as a function of drain-source voltage; typical values**



$I_D = -180 \text{ mA}; V_{DS} = -25 \text{ V}; T_{amb} = 25 \text{ }^\circ\text{C}$

Fig 27. TR2: Gate-source voltage as a function of gate charge; typical values



$V_{GS} = 0 \text{ V}$   
 (1)  $T_j = 150 \text{ }^\circ\text{C}$   
 (2)  $T_j = 25 \text{ }^\circ\text{C}$

Fig 28. TR2: Source current as a function of source-drain voltage; typical values

## 8. Test information

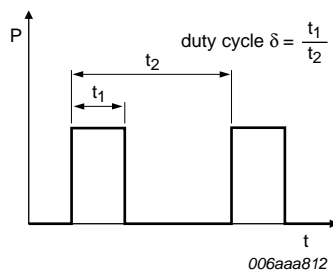


Fig 29. Duty cycle definition

### 8.1 Quality information

This product has been qualified in accordance with the Automotive Electronics Council (AEC) standard Q101 - *Stress test qualification for discrete semiconductors*, and is suitable for use in automotive applications.

9. Package outline

Plastic surface-mounted package; 6 leads

SOT666

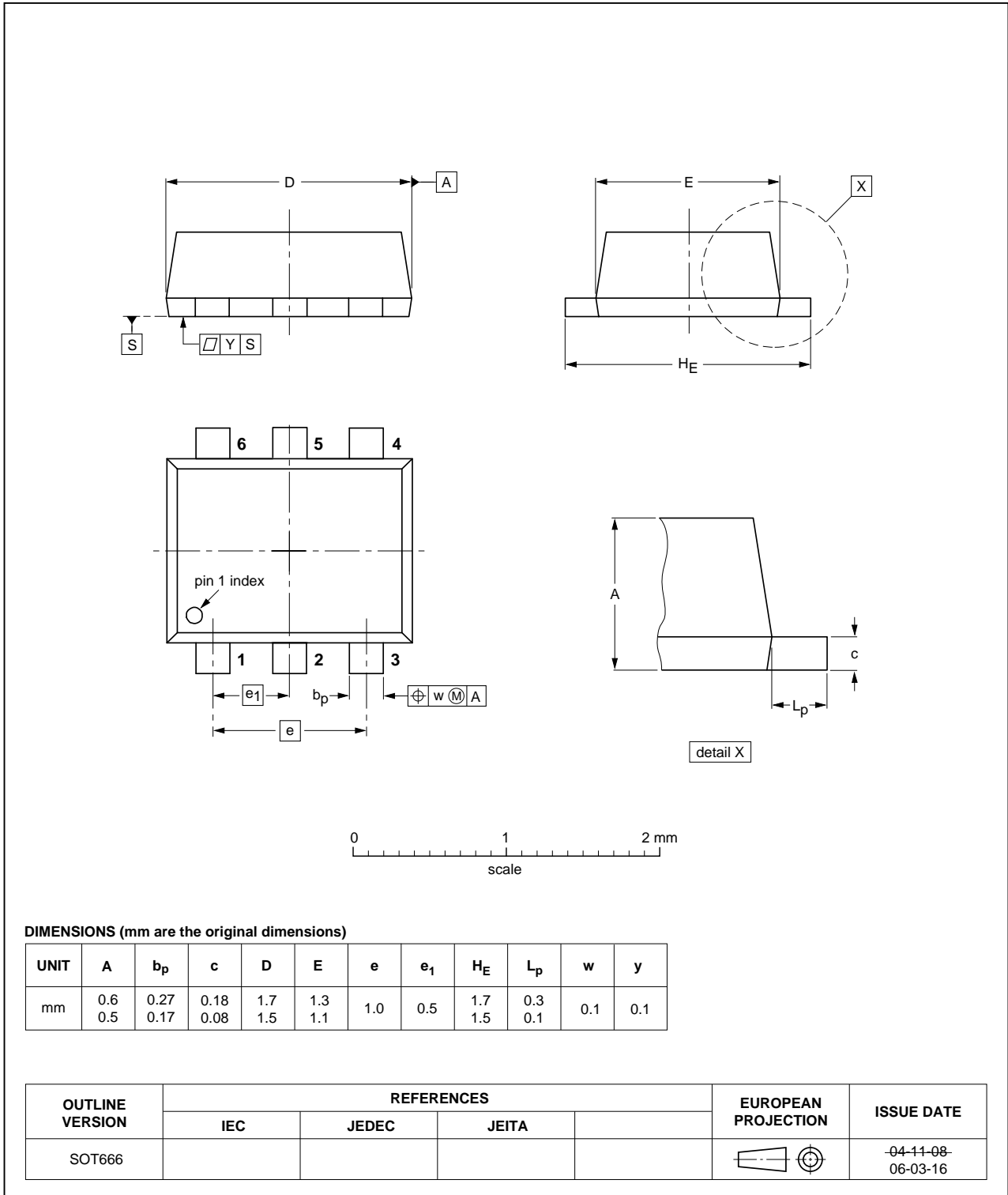


Fig 30. Package outline SOT666 (SOT666)

10. Soldering

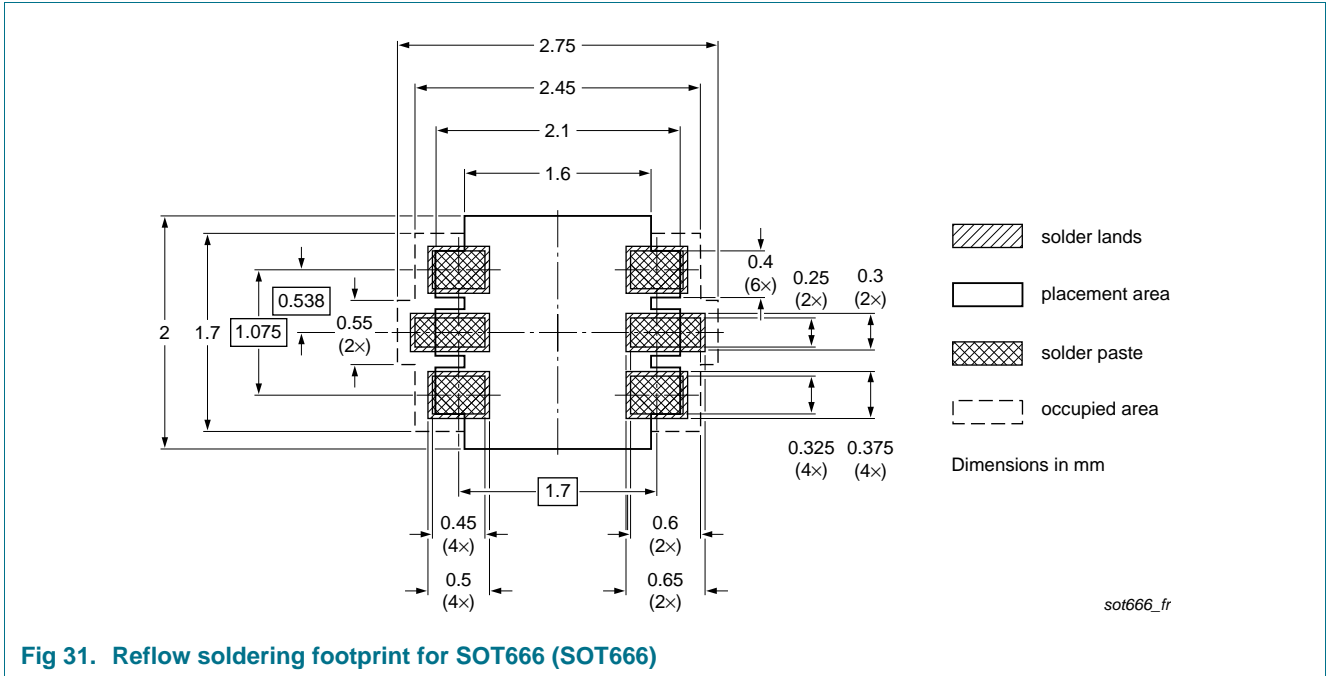


Fig 31. Reflow soldering footprint for SOT666 (SOT666)



## 11. Revision history

Table 8. Revision history

Document ID	Release date	Data sheet status	Change notice	Supersedes
NX1029X v.1	20110812	Product data sheet	-	-

## 12. Legal information

### 12.1 Data sheet status

Document status <sup>[1]</sup> <sup>[2]</sup>	Product status <sup>[3]</sup>	Definition
Objective [short] data sheet	Development	This document contains data from the objective specification for product development.
Preliminary [short] data sheet	Qualification	This document contains data from the preliminary specification.
Product [short] data sheet	Production	This document contains the product specification.

[1] Please consult the most recently issued document before initiating or completing a design.

[2] The term 'short data sheet' is explained in section "Definitions".

[3] The product status of device(s) described in this document may have changed since this document was published and may differ in case of multiple devices. The latest product status information is available on the Internet at URL <http://www.nexperia.com>.

### 12.2 Definitions

**Preview** — The document is a preview version only. The document is still subject to formal approval, which may result in modifications or additions. Nexperia does not give any representations or warranties as to the accuracy or completeness of information included herein and shall have no liability for the consequences of use of such information.

**Draft** — The document is a draft version only. The content is still under internal review and subject to formal approval, which may result in modifications or additions. Nexperia does not give any representations or warranties as to the accuracy or completeness of information included herein and shall have no liability for the consequences of use of such information.

**Short data sheet** — A short data sheet is an extract from a full data sheet with the same product type number(s) and title. A short data sheet is intended for quick reference only and should not be relied upon to contain detailed and full information. For detailed and full information see the relevant full data sheet, which is available on request via the local Nexperia sales office. In case of any inconsistency or conflict with the short data sheet, the full data sheet shall prevail.

**Product specification** — The information and data provided in a Product data sheet shall define the specification of the product as agreed between Nexperia and its customer, unless Nexperia and customer have explicitly agreed otherwise in writing. In no event however, shall an agreement be valid in which the Nexperia product is deemed to offer functions and qualities beyond those described in the Product data sheet.

### 12.3 Disclaimers

**Limited warranty and liability** — Information in this document is believed to be accurate and reliable. However, Nexperia does not give any representations or warranties, expressed or implied, as to the accuracy or completeness of such information and shall have no liability for the consequences of use of such information.

In no event shall Nexperia be liable for any indirect, incidental, punitive, special or consequential damages (including - without limitation - lost profits, lost savings, business interruption, costs related to the removal or replacement of any products or rework charges) whether or not such damages are based on tort (including negligence), warranty, breach of contract or any other legal theory.

Notwithstanding any damages that customer might incur for any reason whatsoever, Nexperia's aggregate and cumulative liability towards customer for the products described herein shall be limited in accordance with the *Terms and conditions of commercial sale* of Nexperia.

**Right to make changes** — Nexperia reserves the right to make changes to information published in this document, including without limitation specifications and product descriptions, at any time and without notice. This document supersedes and replaces all information supplied prior to the publication hereof.

**Suitability for use** — Nexperia products are not designed, authorized or warranted to be suitable for use in life support, life-critical or safety-critical systems or equipment, nor in applications where failure or malfunction of a Nexperia product can reasonably be expected to result in personal injury, death or severe property or environmental damage. Nexperia accepts no liability for inclusion and/or use of Nexperia products in such equipment or applications and therefore such inclusion and/or use is at the customer's own risk.

**Quick reference data** — The Quick reference data is an extract of the product data given in the Limiting values and Characteristics sections of this document, and as such is not complete, exhaustive or legally binding.

**Applications** — Applications that are described herein for any of these products are for illustrative purposes only. Nexperia makes no representation or warranty that such applications will be suitable for the specified use without further testing or modification.

Customers are responsible for the design and operation of their applications and products using Nexperia products, and Nexperia accepts no liability for any assistance with applications or customer product design. It is customer's sole responsibility to determine whether the Nexperia product is suitable and fit for the customer's applications and products planned, as well as for the planned application and use of customer's third party customer(s). Customers should provide appropriate design and operating safeguards to minimize the risks associated with their applications and products.

Nexperia does not accept any liability related to any default, damage, costs or problem which is based on any weakness or default in the customer's applications or products, or the application or use by customer's third party customer(s). Customer is responsible for doing all necessary testing for the customer's applications and products using Nexperia products in order to avoid a default of the applications and the products or of the application or use by customer's third party customer(s). Nexperia does not accept any liability in this respect.

**Limiting values** — Stress above one or more limiting values (as defined in the Absolute Maximum Ratings System of IEC 60134) will cause permanent damage to the device. Limiting values are stress ratings only and (proper) operation of the device at these or any other conditions above those given in the Recommended operating conditions section (if present) or the Characteristics sections of this document is not warranted. Constant or repeated exposure to limiting values will permanently and irreversibly affect the quality and reliability of the device.

**Terms and conditions of commercial sale** — Nexperia products are sold subject to the general terms and conditions of commercial sale, as published at <http://www.nexperia.com/profile/terms>, unless otherwise agreed in a valid written individual agreement. In case an individual agreement is concluded only the terms and conditions of the respective agreement shall apply. Nexperia hereby expressly objects to applying the customer's general terms and conditions with regard to the purchase of Nexperia products by customer.

**No offer to sell or license** — Nothing in this document may be interpreted or construed as an offer to sell products that is open for acceptance or the grant, conveyance or implication of any license under any copyrights, patents or other industrial or intellectual property rights.

**Export control** — This document as well as the item(s) described herein may be subject to export control regulations. Export might require a prior authorization from national authorities.

## 12.4 Trademarks

Notice: All referenced brands, product names, service names and trademarks are the property of their respective owners.

## 13. Contact information

---

For more information, please visit: <http://www.nexperia.com>

For sales office addresses, please send an email to: [salesaddresses@nexperia.com](mailto:salesaddresses@nexperia.com)

## 14. Contents

---

<b>1</b>	<b>Product profile</b> . . . . .	<b>1</b>
1.1	General description . . . . .	1
1.2	Features and benefits . . . . .	1
1.3	Applications . . . . .	1
1.4	Quick reference data . . . . .	1
<b>2</b>	<b>Pinning information</b> . . . . .	<b>2</b>
<b>3</b>	<b>Ordering information</b> . . . . .	<b>2</b>
<b>4</b>	<b>Marking</b> . . . . .	<b>2</b>
<b>5</b>	<b>Limiting values</b> . . . . .	<b>3</b>
<b>6</b>	<b>Thermal characteristics</b> . . . . .	<b>5</b>
<b>7</b>	<b>Characteristics</b> . . . . .	<b>8</b>
<b>8</b>	<b>Test information</b> . . . . .	<b>14</b>
8.1	Quality information . . . . .	14
<b>9</b>	<b>Package outline</b> . . . . .	<b>15</b>
<b>10</b>	<b>Soldering</b> . . . . .	<b>16</b>
<b>11</b>	<b>Revision history</b> . . . . .	<b>17</b>
<b>12</b>	<b>Legal information</b> . . . . .	<b>18</b>
12.1	Data sheet status . . . . .	18
12.2	Definitions . . . . .	18
12.3	Disclaimers . . . . .	18
12.4	Trademarks . . . . .	19
<b>13</b>	<b>Contact information</b> . . . . .	<b>19</b>

单击下面可查看定价，库存，交付和生命周期等信息

[>>Nexperia\(安世\)](#)