

Important notice

Dear Customer,

On 7 February 2017 the former NXP Standard Product business became a new company with the tradename **Nexperia**. Nexperia is an industry leading supplier of Discrete, Logic and PowerMOS semiconductors with its focus on the automotive, industrial, computing, consumer and wearable application markets

In data sheets and application notes which still contain NXP or Philips Semiconductors references, use the references to Nexperia, as shown below.

Instead of <http://www.nxp.com>, <http://www.philips.com/> or <http://www.semiconductors.philips.com/>, use <http://www.nexperia.com>

Instead of sales.addresses@www.nxp.com or sales.addresses@www.semiconductors.philips.com, use salesaddresses@nexperia.com (email)

Replace the copyright notice at the bottom of each page or elsewhere in the document, depending on the version, as shown below:

- © NXP N.V. (year). All rights reserved or © Koninklijke Philips Electronics N.V. (year). All rights reserved

Should be replaced with:

- © **Nexperia B.V. (year). All rights reserved.**

If you have any questions related to the data sheet, please contact our nearest sales office via e-mail or telephone (details via salesaddresses@nexperia.com). Thank you for your cooperation and understanding,

Kind regards,

Team Nexperia

DATA SHEET



PBSS4540X

40 V, 5 A

NPN low V_{CEsat} (BISS) transistor

Product data sheet
Supersedes data of 2004 Jun 11

2004 Nov 04



**40 V, 5 A
NPN low V_{CEsat} (BISS) transistor**

PBSS4540X

FEATURES

- High h_{FE} and low V_{CEsat} at high current operation
- High collector current capability: I_C maximum 4 A
- High efficiency leading to less heat generation.

APPLICATIONS

- Medium power peripheral drivers (e.g. fan and motor)
- Strobe flash units for DSC and mobile phones
- Inverter applications (e.g. TFT displays)
- Power switch for LAN and ADSL systems
- Medium power DC-to-DC conversion
- Battery chargers.

DESCRIPTION

NPN low V_{CEsat} transistor in a medium power SOT89 (SC-62) package.
PNP complement: PBSS5540X.

MARKING

TYPE NUMBER	MARKING CODE ⁽¹⁾
PBSS4540X	*1B

Note

- * = p: made in Hong Kong.
* = t: made in Malaysia.
* = W: made in China.

QUICK REFERENCE DATA

SYMBOL	PARAMETER	MAX.	UNIT
V_{CEO}	collector-emitter voltage	40	V
I_C	collector current (DC)	4	A
I_{CM}	peak collector current	10	A
R_{CEsat}	equivalent on-resistance	71	m Ω

PINNING

PIN	DESCRIPTION
1	emitter
2	collector
3	base

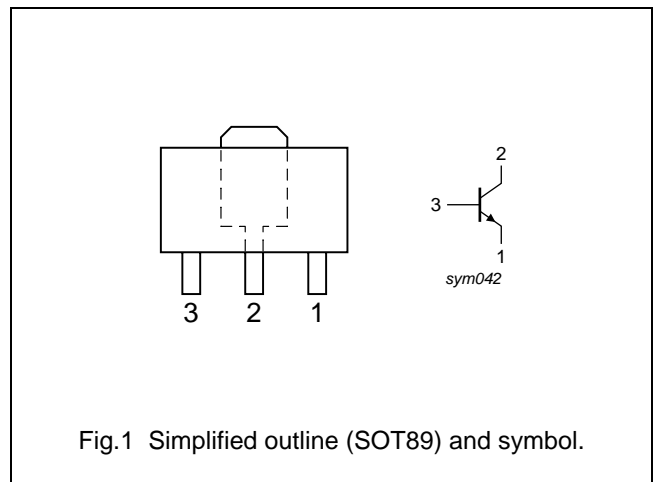

Fig.1 Simplified outline (SOT89) and symbol.

ORDERING INFORMATION

TYPE NUMBER	PACKAGE		
	NAME	DESCRIPTION	VERSION
PBSS4540X	SC-62	plastic surface mounted package; collector pad for good heat transfer; 3 leads	SOT89

40 V, 5 A
NPN low V_{CEsat} (BISS) transistor

PBSS4540X

LIMITING VALUES

In accordance with the Absolute Maximum Rating System (IEC 60134).

SYMBOL	PARAMETER	CONDITIONS	MIN.	MAX.	UNIT
V_{CBO}	collector-base voltage	open emitter	–	40	V
V_{CEO}	collector-emitter voltage	open base	–	40	V
V_{EBO}	emitter-base voltage	open collector	–	6	V
I_C	collector current (DC)		–	4	A
I_{CRM}	maximum repetitive collector current	notes 1 and 2	–	5	A
I_{CM}	peak collector current	$t_p \leq 1$ ms	–	10	A
I_B	base current (DC)		–	1	A
I_{BM}	peak base current	$t_p \leq 1$ ms	–	2	A
P_{tot}	total power dissipation	$T_{amb} \leq 25$ °C notes 1 and 2 note 2 note 3 note 4 note 5	–	2.5 0.55 1 1.4 1.6	W W W W W
T_{stg}	storage temperature		–65	+150	°C
T_j	junction temperature		–	150	°C
T_{amb}	operating ambient temperature		–65	+150	°C

Notes

1. Operated under pulsed conditions; pulse width $t_p \leq 10$ ms; duty cycle $\delta \leq 0.2$.
2. Device mounted on a printed-circuit board, single-sided copper, tin-plated and standard footprint.
3. Device mounted on a printed-circuit board, single-sided copper, tin-plated and mounting pad for collector 1 cm².
4. Device mounted on a printed-circuit board, single-sided copper, tin-plated and mounting pad for collector 6 cm².
5. Device mounted on a 7 cm² ceramic printed-circuit board, 1 cm² single-sided copper and tin-plated. For other mounting conditions, see "Thermal considerations for SOT89 in the General Part of associated Handbook".

40 V, 5 A
 NPN low V_{CEsat} (BISS) transistor

PBSS4540X

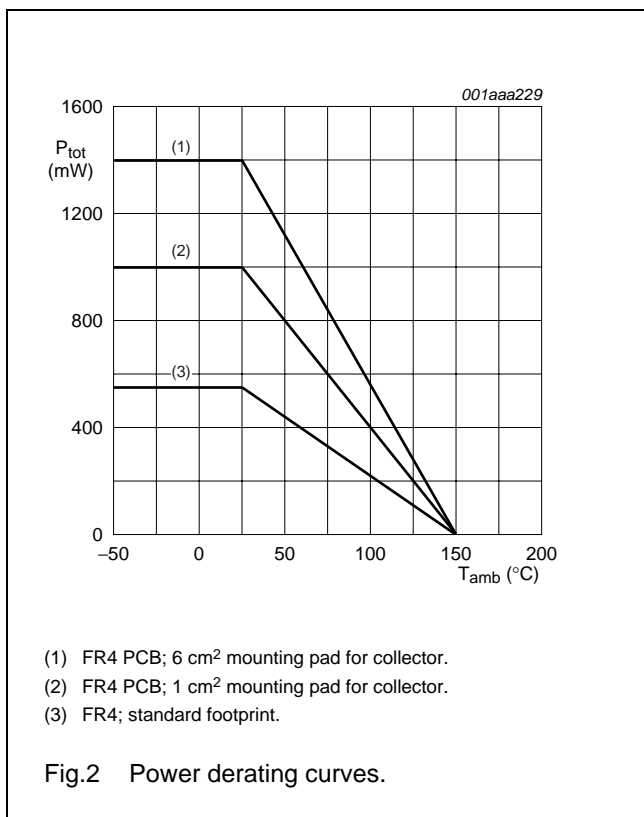

40 V, 5 A
NPN low V_{CEsat} (BISS) transistor

PBSS4540X

THERMAL CHARACTERISTICS

SYMBOL	PARAMETER	CONDITIONS	VALUE	UNIT
$R_{th(j-a)}$	from junction to ambient	in free air		
		notes 1 and 2	50	K/W
		note 2	225	K/W
		note 3	125	K/W
		note 4	90	K/W
	note 5	80	K/W	
$R_{th(j-s)}$	from junction to soldering point		16	K/W

Notes

1. Operated under pulsed conditions; pulse width $t_p \leq 10$ ms; duty cycle $\delta \leq 0.2$.
2. Device mounted on a printed-circuit board, single-sided copper, tin-plated and standard footprint.
3. Device mounted on a printed-circuit board, single-sided copper, tin-plated and mounting pad for collector 1 cm².
4. Device mounted on a printed-circuit board, single-sided copper, tin-plated and mounting pad for collector 6 cm².
5. Device mounted on a 7 cm² ceramic printed-circuit board, 1 cm² single-sided copper and tin-plated. For other mounting conditions, see "Thermal considerations for SOT89 in the General Part of associated Handbook".

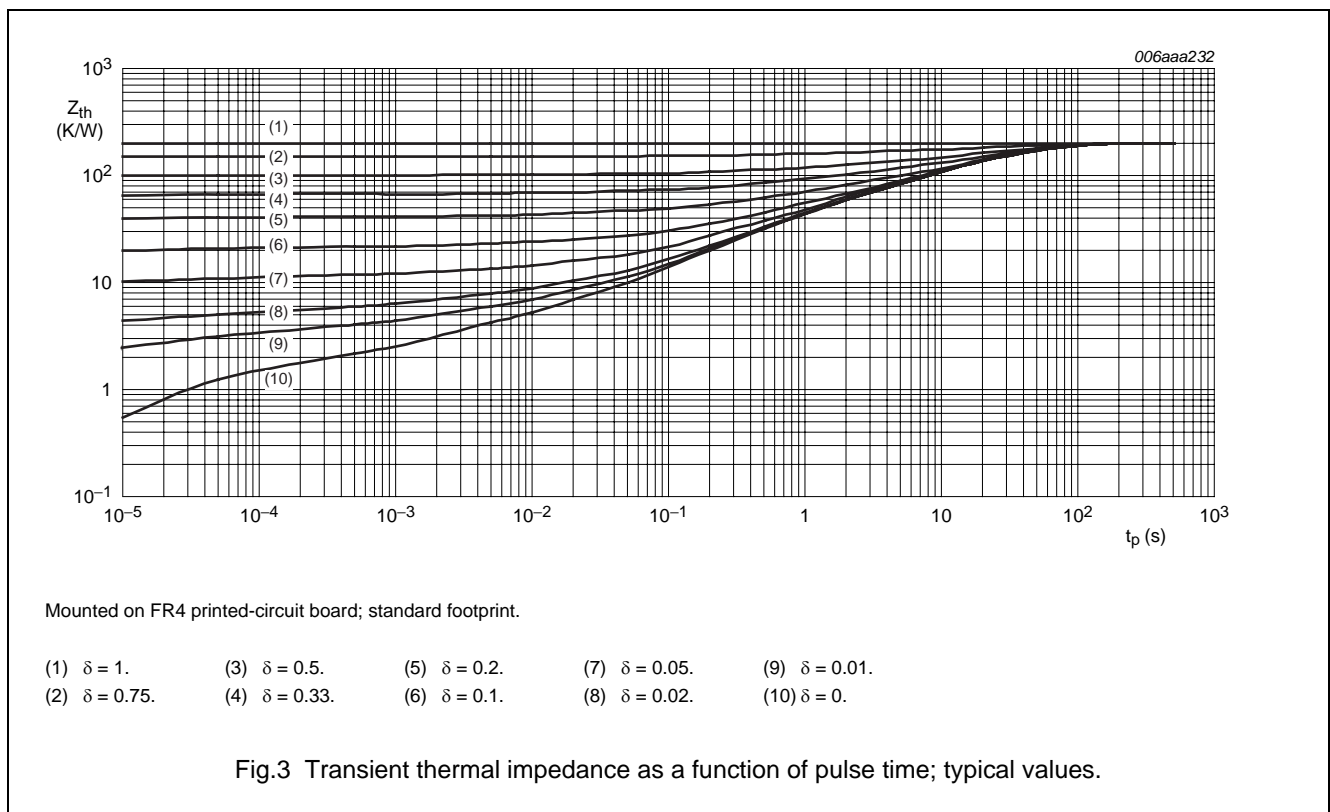

40 V, 5 A
NPN low V_{CEsat} (BISS) transistor

PBSS4540X

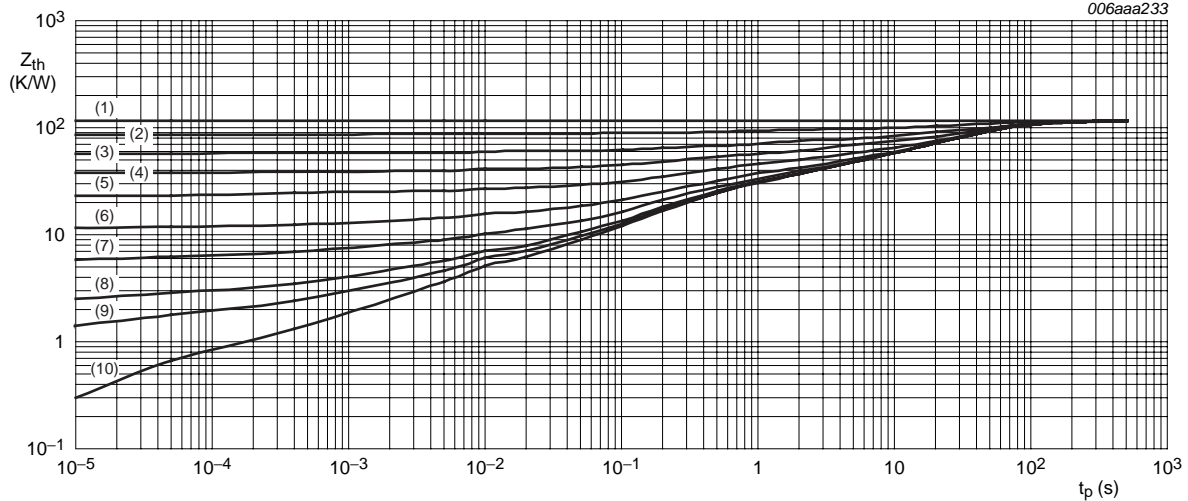

Mounted on FR4 printed-circuit board; mounting pad for collector 1 cm².

- | | | | | |
|----------------------|----------------------|---------------------|----------------------|----------------------|
| (1) $\delta = 1.$ | (3) $\delta = 0.5.$ | (5) $\delta = 0.2.$ | (7) $\delta = 0.05.$ | (9) $\delta = 0.01.$ |
| (2) $\delta = 0.75.$ | (4) $\delta = 0.33.$ | (6) $\delta = 0.1.$ | (8) $\delta = 0.02.$ | (10) $\delta = 0.$ |

Fig.4 Transient thermal impedance as a function of pulse time; typical values.

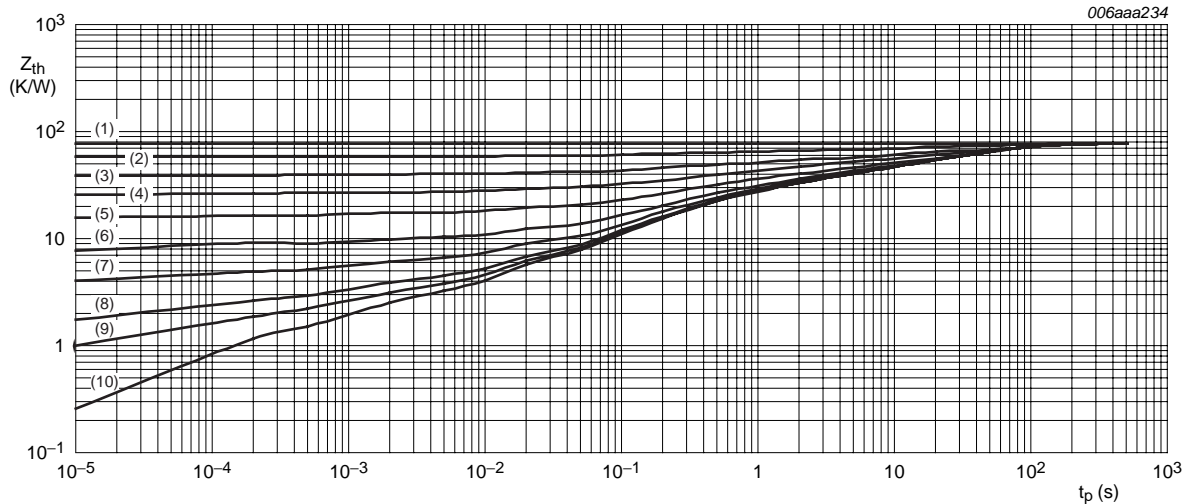

Mounted on FR4 printed-circuit board; mounting pad for collector 6 cm².

- | | | | | |
|----------------------|----------------------|---------------------|----------------------|----------------------|
| (1) $\delta = 1.$ | (3) $\delta = 0.5.$ | (5) $\delta = 0.2.$ | (7) $\delta = 0.05.$ | (9) $\delta = 0.01.$ |
| (2) $\delta = 0.75.$ | (4) $\delta = 0.33.$ | (6) $\delta = 0.1.$ | (8) $\delta = 0.02.$ | (10) $\delta = 0.$ |

Fig.5 Transient thermal impedance as a function of pulse time; typical values.

40 V, 5 A
NPN low V_{CEsat} (BISS) transistor

PBSS4540X

CHARACTERISTICS $T_{amb} = 25\text{ °C}$ unless otherwise specified.

SYMBOL	PARAMETER	CONDITIONS	MIN.	TYP.	MAX.	UNIT
I_{CBO}	collector-base cut-off current	$V_{CB} = 30\text{ V}; I_E = 0\text{ A}$	–	–	100	nA
		$V_{CB} = 30\text{ V}; I_E = 0\text{ A}; T_j = 150\text{ °C}$	–	–	50	μA
I_{CES}	collector-emitter cut-off current	$V_{CE} = 30\text{ V}; V_{BE} = 0\text{ V}$	–	–	0.1	μA
I_{EBO}	emitter-base cut-off current	$V_{EB} = 5\text{ V}; I_C = 0\text{ A}$	–	–	100	nA
h_{FE}	DC current gain	$V_{CE} = 2\text{ V}; I_C = 0.5\text{ A}$	300	–	–	
		$V_{CE} = 2\text{ V}; I_C = 1\text{ A};$ note 1	300	–	–	
		$V_{CE} = 2\text{ V}; I_C = 2\text{ A};$ note 1	250	–	–	
		$V_{CE} = 2\text{ V}; I_C = 5\text{ A};$ note 1	100	–	–	
V_{CEsat}	collector-emitter saturation voltage	$I_C = 0.5\text{ A}; I_B = 5\text{ mA}$	–	–	90	mV
		$I_C = 1\text{ A}; I_B = 10\text{ mA}$	–	–	120	mV
		$I_C = 2\text{ A}; I_B = 200\text{ mA};$ note 1	–	–	150	mV
		$I_C = 4\text{ A}; I_B = 200\text{ mA};$ note 1	–	–	290	mV
		$I_C = 5\text{ A}; I_B = 500\text{ mA};$ note 1	–	–	355	mV
R_{CEsat}	equivalent on-resistance	$I_C = 5\text{ A}; I_B = 500\text{ mA};$ note 1	–	40	71	$\text{m}\Omega$
V_{BEsat}	base-emitter saturation voltage	$I_C = 4\text{ A}; I_B = 200\text{ mA};$ note 1	–	–	1.1	V
		$I_C = 5\text{ A}; I_B = 500\text{ mA};$ note 1	–	–	1.2	V
V_{BEon}	base-emitter turn-on voltage	$V_{CE} = 2\text{ V}; I_C = 2\text{ A}$	–	–	1.1	V
f_T	transition frequency	$V_{CE} = 10\text{ V}; I_C = 0.1\text{ A};$ $f = 100\text{ MHz}$	70	–	–	MHz
C_c	collector capacitance	$V_{CB} = 10\text{ V}; I_E = I_C = 0\text{ A};$ $f = 1\text{ MHz}$	–	–	75	pF

Note

1. Pulse test: $t_p \leq 300\text{ }\mu\text{s}; \delta \leq 0.02$.

40 V, 5 A
NPN low V_{CEsat} (BISS) transistor

PBSS4540X

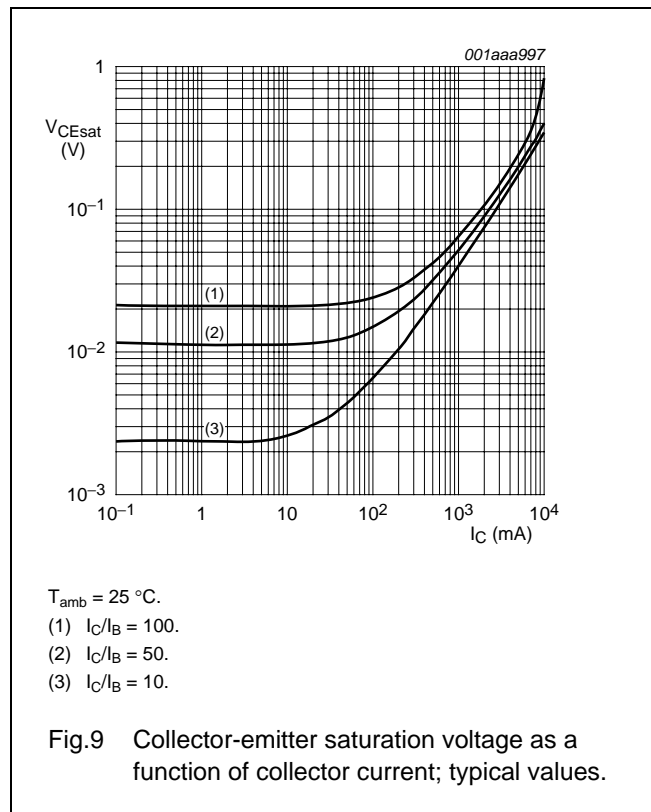
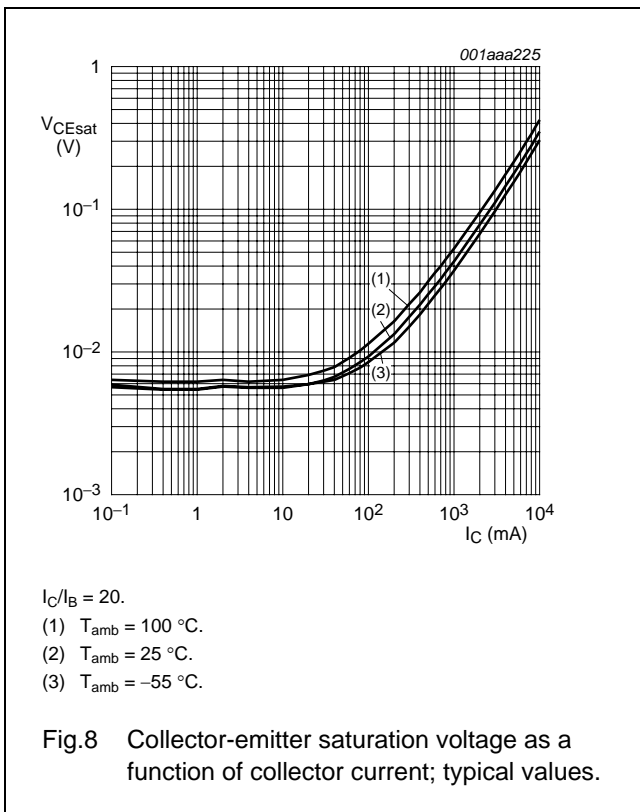
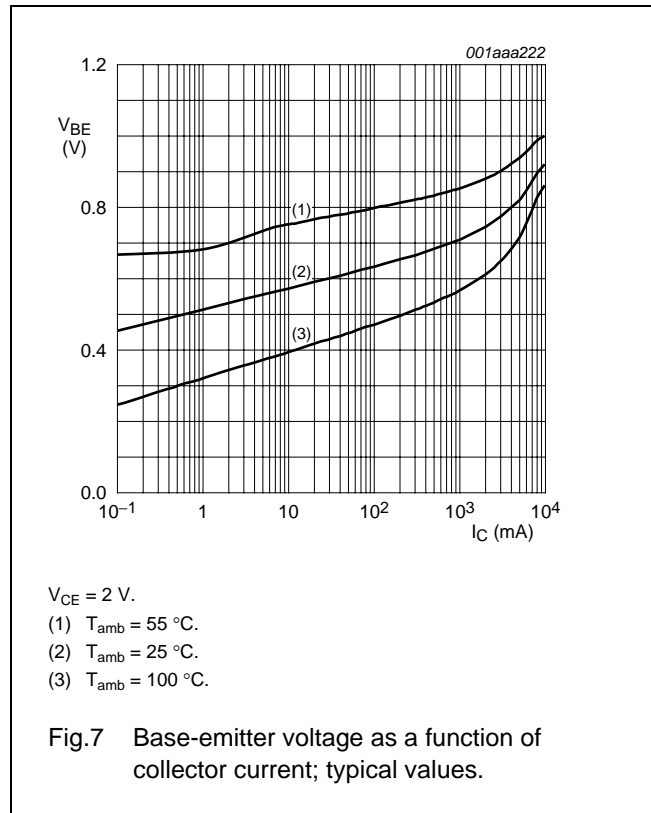
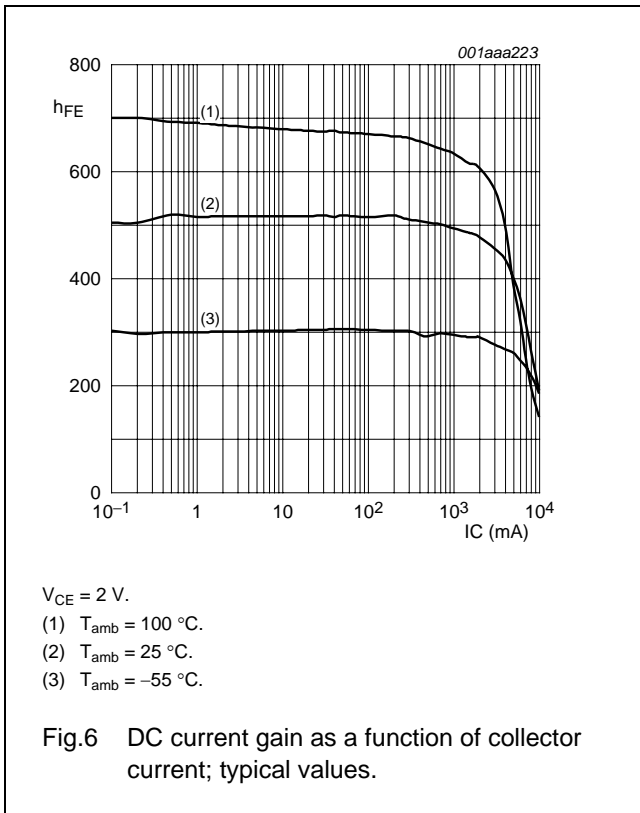

40 V, 5 A
NPN low V_{CEsat} (BISS) transistor

PBSS4540X

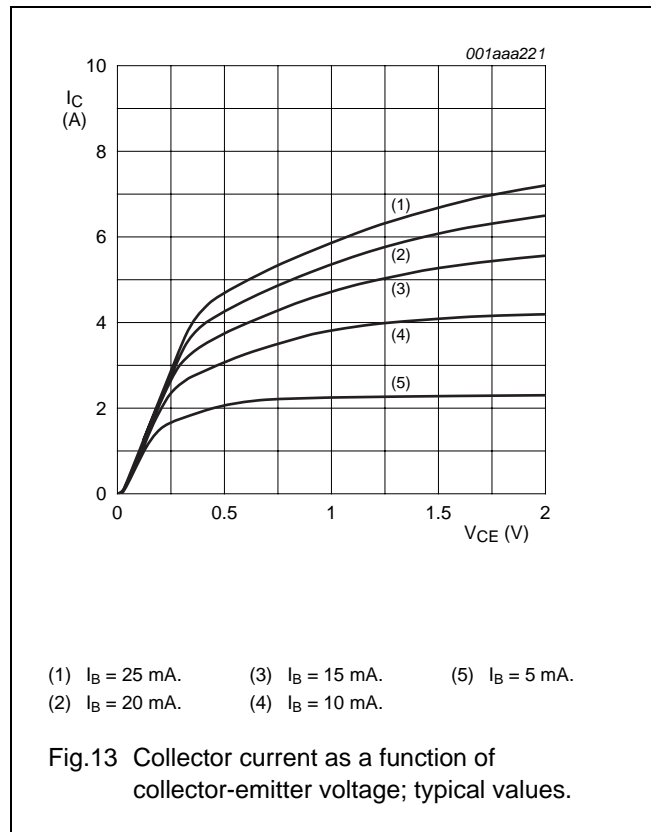
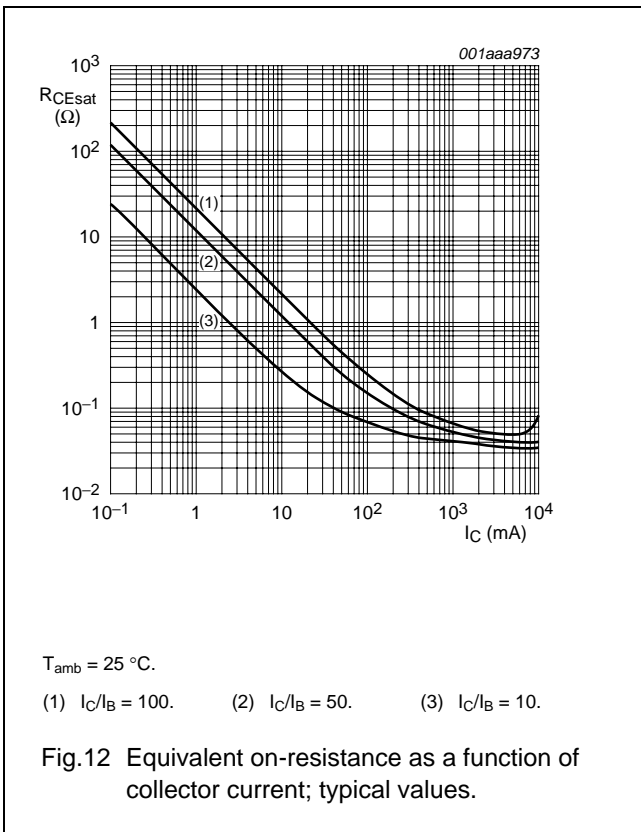
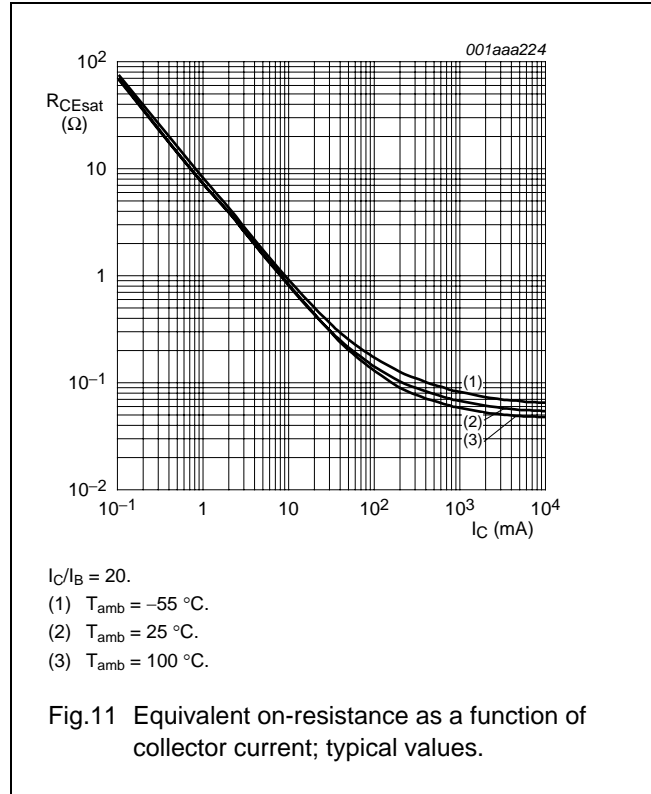
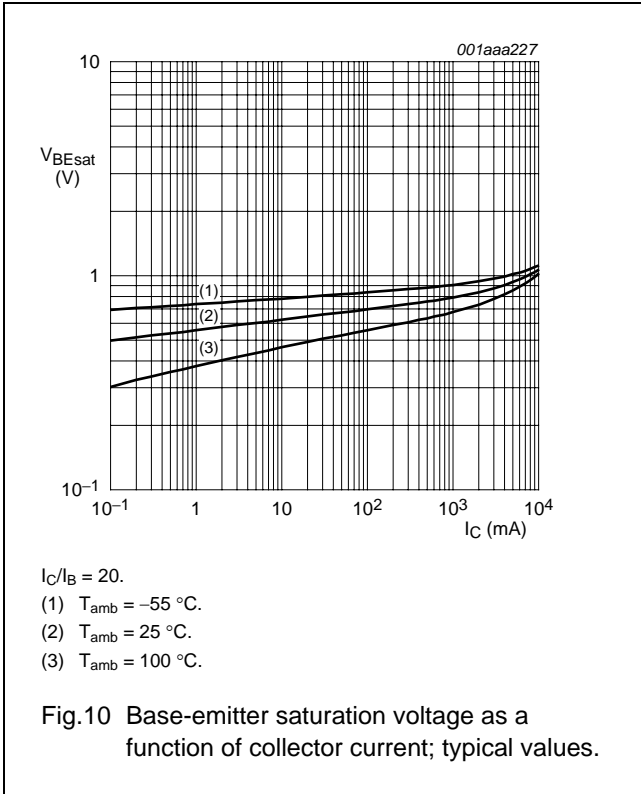

40 V, 5 A
NPN low V_{CEsat} (BISS) transistor

PBSS4540X

Reference mounting conditions

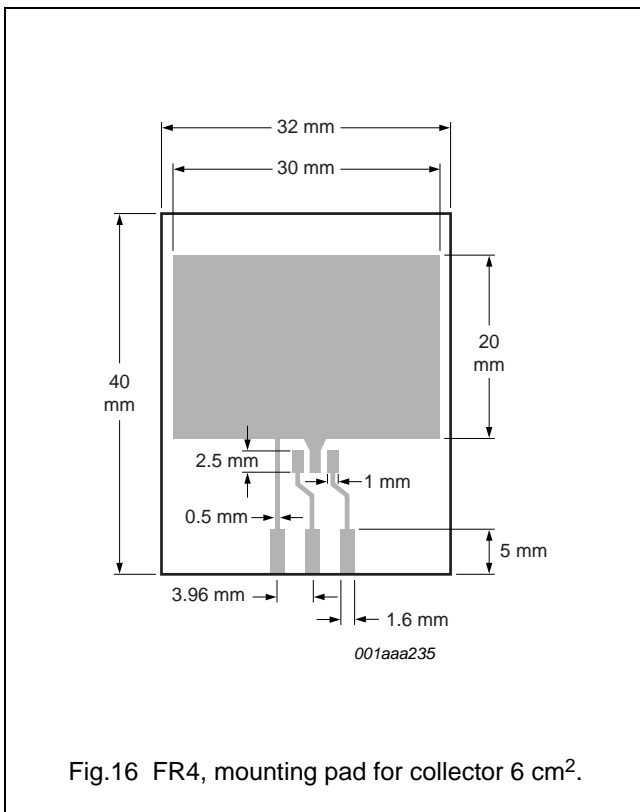
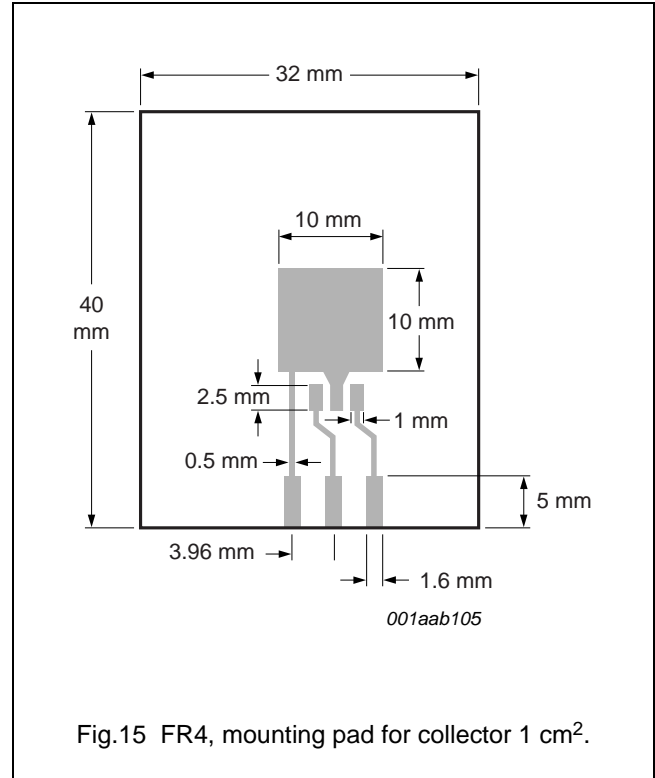
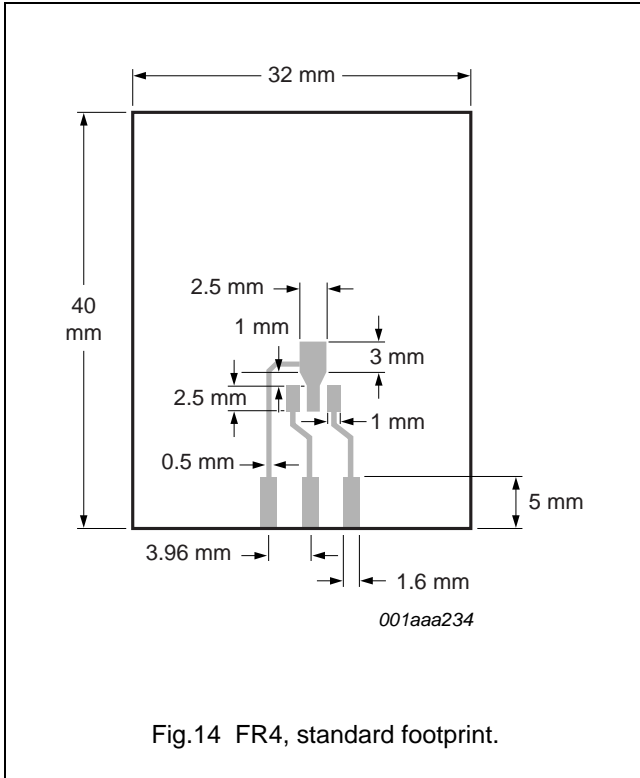

40 V, 5 A
NPN low V_{CEsat} (BISS) transistor

PBSS4540X

PACKAGE OUTLINE

Plastic surface-mounted package; collector pad for good heat transfer; 3 leads

SOT89

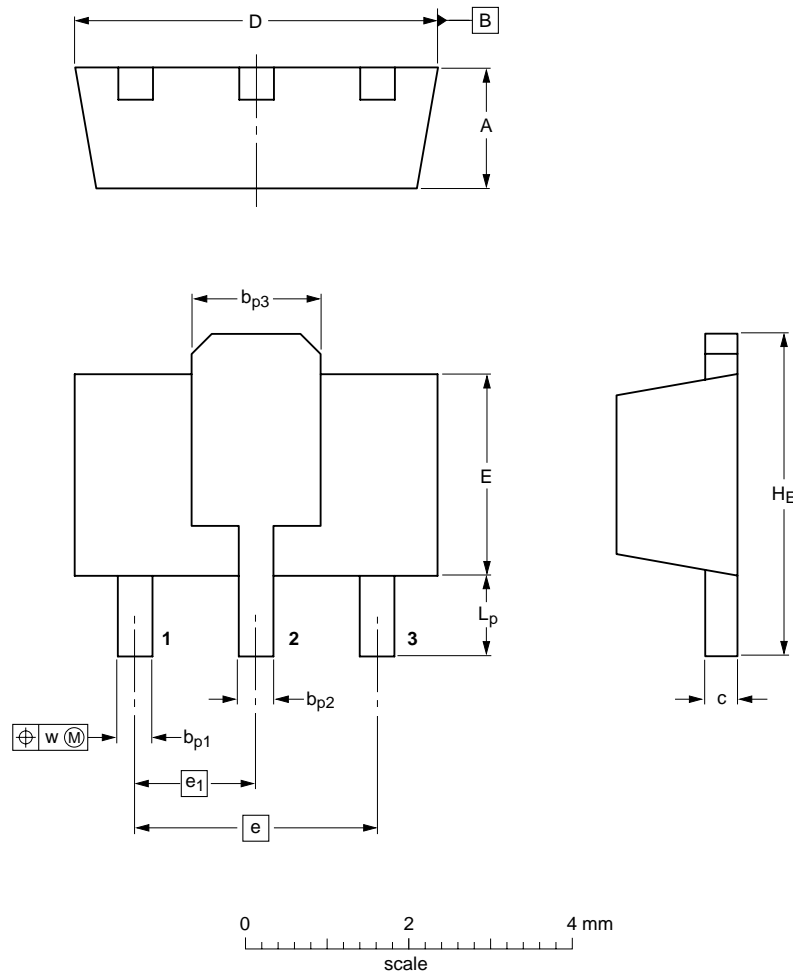

DIMENSIONS (mm are the original dimensions)

UNIT	A	b _{p1}	b _{p2}	b _{p3}	c	D	E	e	e ₁	H _E	L _p	w
mm	1.6 1.4	0.48 0.35	0.53 0.40	1.8 1.4	0.44 0.23	4.6 4.4	2.6 2.4	3.0	1.5	4.25 3.75	1.2 0.8	0.13

OUTLINE VERSION	REFERENCES			EUROPEAN PROJECTION	ISSUE DATE
	IEC	JEDEC	JEITA		
SOT89		TO-243	SC-62		04-08-03 06-03-16

40 V, 5 A
NPN low V_{CEsat} (BISS) transistor

PBSS4540X

DATA SHEET STATUS

DOCUMENT STATUS ⁽¹⁾	PRODUCT STATUS ⁽²⁾	DEFINITION
Objective data sheet	Development	This document contains data from the objective specification for product development.
Preliminary data sheet	Qualification	This document contains data from the preliminary specification.
Product data sheet	Production	This document contains the product specification.

Notes

1. Please consult the most recently issued document before initiating or completing a design.
2. The product status of device(s) described in this document may have changed since this document was published and may differ in case of multiple devices. The latest product status information is available on the Internet at URL <http://www.nxp.com>.

DISCLAIMERS

General — Information in this document is believed to be accurate and reliable. However, NXP Semiconductors does not give any representations or warranties, expressed or implied, as to the accuracy or completeness of such information and shall have no liability for the consequences of use of such information.

Right to make changes — NXP Semiconductors reserves the right to make changes to information published in this document, including without limitation specifications and product descriptions, at any time and without notice. This document supersedes and replaces all information supplied prior to the publication hereof.

Suitability for use — NXP Semiconductors products are not designed, authorized or warranted to be suitable for use in medical, military, aircraft, space or life support equipment, nor in applications where failure or malfunction of an NXP Semiconductors product can reasonably be expected to result in personal injury, death or severe property or environmental damage. NXP Semiconductors accepts no liability for inclusion and/or use of NXP Semiconductors products in such equipment or applications and therefore such inclusion and/or use is at the customer's own risk.

Applications — Applications that are described herein for any of these products are for illustrative purposes only. NXP Semiconductors makes no representation or warranty that such applications will be suitable for the specified use without further testing or modification.

Limiting values — Stress above one or more limiting values (as defined in the Absolute Maximum Ratings System of IEC 60134) may cause permanent damage to the device. Limiting values are stress ratings only and operation of the device at these or any other conditions

above those given in the Characteristics sections of this document is not implied. Exposure to limiting values for extended periods may affect device reliability.

Terms and conditions of sale — NXP Semiconductors products are sold subject to the general terms and conditions of commercial sale, as published at <http://www.nxp.com/profile/terms>, including those pertaining to warranty, intellectual property rights infringement and limitation of liability, unless explicitly otherwise agreed to in writing by NXP Semiconductors. In case of any inconsistency or conflict between information in this document and such terms and conditions, the latter will prevail.

No offer to sell or license — Nothing in this document may be interpreted or construed as an offer to sell products that is open for acceptance or the grant, conveyance or implication of any license under any copyrights, patents or other industrial or intellectual property rights.

Export control — This document as well as the item(s) described herein may be subject to export control regulations. Export might require a prior authorization from national authorities.

Quick reference data — The Quick reference data is an extract of the product data given in the Limiting values and Characteristics sections of this document, and as such is not complete, exhaustive or legally binding.

NXP Semiconductors

Customer notification

This data sheet was changed to reflect the new company name NXP Semiconductors, including new legal definitions and disclaimers. No changes were made to the technical content, except for package outline drawings which were updated to the latest version.

Contact information

For additional information please visit: <http://www.nxp.com>

For sales offices addresses send e-mail to: salesaddresses@nxp.com

© NXP B.V. 2009

All rights are reserved. Reproduction in whole or in part is prohibited without the prior written consent of the copyright owner.

The information presented in this document does not form part of any quotation or contract, is believed to be accurate and reliable and may be changed without notice. No liability will be accepted by the publisher for any consequence of its use. Publication thereof does not convey nor imply any license under patent- or other industrial or intellectual property rights.

Printed in The Netherlands

R75/03/pp13

Date of release: 2004 Nov 04

Document order number: 9397 750 13885



单击下面可查看定价，库存，交付和生命周期等信息

[>>Nexperia\(安世\)](#)