

# XC7SET02

## 2-input NOR gate

Rev. 01 — 31 August 2009

Product data sheet

### 1. General description

XC7SET02 is a high-speed Si-gate CMOS device. It provides a 2-input NOR function.

### 2. Features

- Symmetrical output impedance
- High noise immunity
- Low power dissipation
- Balanced propagation delays
- SOT353-1 and SOT753 package options
- ESD protection:
  - ◆ HBM JESD22-A114E: exceeds 2000 V
  - ◆ MM JESD22-A115-A: exceeds 200 V
  - ◆ CDM JESD22-C101C: exceeds 1000 V
- Specified from  $-40\text{ }^{\circ}\text{C}$  to  $+125\text{ }^{\circ}\text{C}$

### 3. Ordering information

Table 1. Ordering information

Type number	Package			
	Temperature range	Name	Description	Version
XC7SET02GW	$-40\text{ }^{\circ}\text{C}$ to $+125\text{ }^{\circ}\text{C}$	TSSOP5	plastic thin shrink small outline package; 5 leads; body width 1.25 mm	SOT353-1
XC7SET02GV	$-40\text{ }^{\circ}\text{C}$ to $+125\text{ }^{\circ}\text{C}$	SC-74A	plastic surface-mounted package; 5 leads	SOT753

nexperia

## 4. Marking

Table 2. Marking codes

Type number	Marking <sup>[1]</sup>
XC7SET02GW	gB
XC7SET02GV	g02

[1] The pin 1 indicator is located on the lower left corner of the device, below the marking code.

## 5. Functional diagram

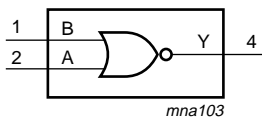

Fig 1. Logic symbol

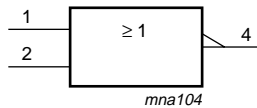

Fig 2. IEC logic symbol

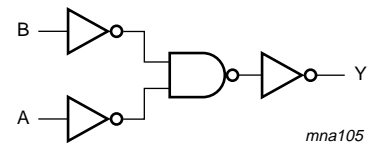

Fig 3. Logic diagram

## 6. Pinning information

### 6.1 Pinning

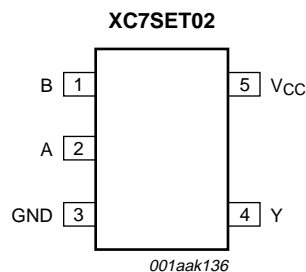

Fig 4. Pin configuration SOT353-1 and SOT753

### 6.2 Pin description

Table 3. Pin description

Symbol	Pin	Description
B	1	data input B
A	2	data input A
GND	3	ground (0 V)
Y	4	data output Y
V <sub>CC</sub>	5	supply voltage

## 7. Functional description

**Table 4. Function table**

*H = HIGH voltage level; L = LOW voltage level*

Inputs		Output
A	B	Y
L	L	H
L	H	L
H	L	L
H	H	L

## 8. Limiting values

**Table 5. Limiting values**

*In accordance with the Absolute Maximum Rating System (IEC 60134).*

Symbol	Parameter	Conditions	Min	Max	Unit
$V_{CC}$	supply voltage		-0.5	+7.0	V
$V_I$	input voltage		-0.5	+7.0	V
$I_{IK}$	input clamping current	$V_I < -0.5$ V	-20	-	mA
$I_{OK}$	output clamping current	$V_O < -0.5$ V or $V_O > V_{CC} + 0.5$ V	[1] -	±20	mA
$I_O$	output current	$-0.5$ V < $V_O$ < $V_{CC} + 0.5$ V	-	±25	mA
$I_{CC}$	supply current		-	75	mA
$I_{GND}$	ground current		-75	-	mA
$T_{stg}$	storage temperature		-65	+150	°C
$P_{tot}$	total power dissipation	$T_{amb} = -40$ °C to +125 °C	[2] -	250	mW

[1] The input and output voltage ratings may be exceeded if the input and output current ratings are observed.

[2] For both TSSOP5 and SC-74A packages: above 87.5 °C the value of  $P_{tot}$  derates linearly with 4.0 mW/K.

## 9. Recommended operating conditions

**Table 6. Recommended operating conditions**

Voltages are referenced to GND (ground = 0 V).

Symbol	Parameter	Conditions	Min	Typ	Max	Unit
$V_{CC}$	supply voltage		4.5	5.0	5.5	V
$V_I$	input voltage		0	-	5.5	V
$V_O$	output voltage		0	-	$V_{CC}$	V
$T_{amb}$	ambient temperature		-40	+25	+125	°C
$\Delta t/\Delta V$	input transition rise and fall rate		-	-	20	ns/V

## 10. Static characteristics

**Table 7. Static characteristics**

Voltages are referenced to GND (ground = 0 V).

Symbol	Parameter	Conditions	25 °C			-40 °C to +85 °C		-40 °C to +125 °C		Unit
			Min	Typ	Max	Min	Max	Min	Max	
$V_{IH}$	HIGH-level input voltage	$V_{CC} = 4.5 \text{ V to } 5.5 \text{ V}$	2.0	-	-	2.0	-	2.0	-	V
$V_{IL}$	LOW-level input voltage	$V_{CC} = 4.5 \text{ V to } 5.5 \text{ V}$	-	-	0.8	-	0.8	-	0.8	V
$V_{OH}$	HIGH-level output voltage	$V_I = V_{IH} \text{ or } V_{IL}; V_{CC} = 4.5 \text{ V}$								
		$I_O = -50 \mu\text{A}$	4.4	4.5	-	4.4	-	4.4	-	V
		$I_O = -8.0 \text{ mA}$	3.94	-	-	3.8	-	3.70	-	V
$V_{OL}$	LOW-level output voltage	$V_I = V_{IH} \text{ or } V_{IL}; V_{CC} = 4.5 \text{ V}$								
		$I_O = 50 \mu\text{A}$	-	0	0.1	-	0.1	-	0.1	V
		$I_O = 8.0 \text{ mA}$	-	-	0.36	-	0.44	-	0.55	V
$I_I$	input leakage current	$V_I = 5.5 \text{ V or GND}; V_{CC} = 0 \text{ V to } 5.5 \text{ V}$	-	-	0.1	-	1.0	-	2.0	$\mu\text{A}$
$I_{CC}$	supply current	$V_I = V_{CC} \text{ or GND}; I_O = 0 \text{ A}; V_{CC} = 5.5 \text{ V}$	-	-	1.0	-	10	-	40	$\mu\text{A}$
$\Delta I_{CC}$	additional supply current	per input pin; $V_I = 3.4 \text{ V};$ other inputs at $V_{CC}$ or GND; $I_O = 0 \text{ A}; V_{CC} = 5.5 \text{ V}$	-	-	1.35	-	1.5	-	1.5	mA
$C_I$	input capacitance		-	1.5	10	-	10	-	10	pF

## 11. Dynamic characteristics

**Table 8. Dynamic characteristics**  
*GND = 0 V. For test circuit see Figure 6.*

Symbol	Parameter	Conditions	25 °C			−40 °C to +85 °C		−40 °C to +125 °C		Unit
			Min	Typ	Max	Min	Max	Min	Max	
$t_{pd}$	propagation delay	A and B to Y; see Figure 5	[1]							
		$V_{CC} = 4.5 \text{ V to } 5.5 \text{ V}$	[2]							
		$C_L = 15 \text{ pF}$	-	3.5	5.5	1.0	6.5	1.0	7.0	ns
		$C_L = 50 \text{ pF}$	-	4.9	7.5	1.0	8.5	1.0	9.5	ns
$C_{PD}$	power dissipation capacitance	per buffer; $C_L = 50 \text{ pF}$ ; $f = 1 \text{ MHz}$ ; $V_I = \text{GND to } V_{CC}$	[3]	-	19	-	-	-	-	pF

[1]  $t_{pd}$  is the same as  $t_{PLH}$  and  $t_{PHL}$ .

[2] Typical values are measured at  $V_{CC} = 5.0 \text{ V}$ .

[3]  $C_{PD}$  is used to determine the dynamic power dissipation  $P_D$  ( $\mu\text{W}$ ).

$P_D = C_{PD} \times V_{CC}^2 \times f_i + \sum(C_L \times V_{CC}^2 \times f_o)$  where:

$f_i$  = input frequency in MHz;  $f_o$  = output frequency in MHz;

$C_L$  = output load capacitance in pF;

$V_{CC}$  = supply voltage in V.

## 12. Waveforms

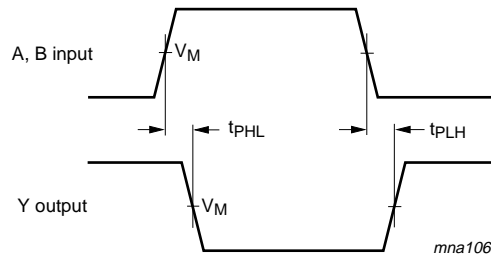

Measurement points are given in [Table 9](#).

**Fig 5. The inputs (A and B) to output (Y) propagation delays**

**Table 9. Measurement point**

Type	Input		Output
	$V_I$	$V_M$	$V_M$
XC7SET02	GND to 3.0 V	1.5 V	$0.5 \times V_{CC}$

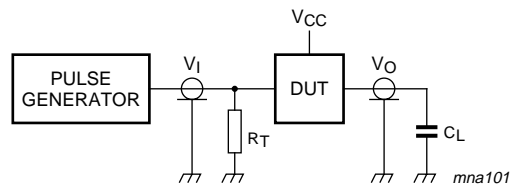

Test data is given in [Table 10](#). Definitions for test circuit:

$C_L$  = Load capacitance including jig and probe capacitance.

$R_T$  = Termination resistance should be equal to output impedance  $Z_o$  of the pulse generator.

**Fig 6. Load circuitry for switching times**

**Table 10. Test data**

Type	Input		Load	Test
	$V_I$	$t_r, t_f$	$C_L$	
XC7SET02	3.0 V	$\leq 3.0$ ns	15 pF, 50 pF	$t_{PLH}, t_{PHL}$

**13. Package outline**

TSSOP5: plastic thin shrink small outline package; 5 leads; body width 1.25 mm

SOT353-1

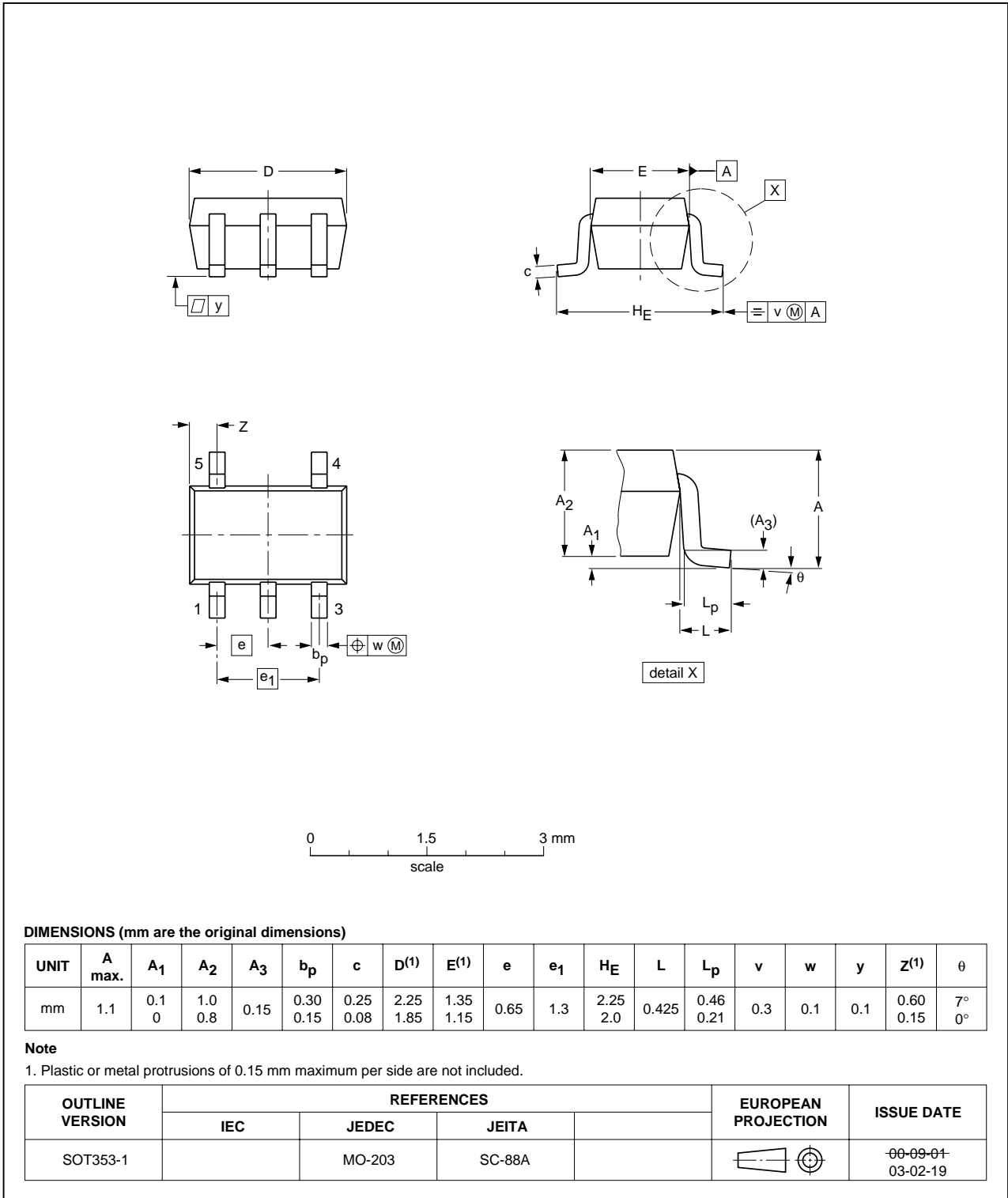

**Fig 7. Package outline SOT353-1 (TSSOP5)**

Plastic surface-mounted package; 5 leads

SOT753



Fig 8. Package outline SOT753 (SC-74A)



## 14. Abbreviations

Table 11. Abbreviations

Acronym	Description
CDM	Charged Device Model
DUT	Device Under Test
ESD	ElectroStatic Discharge
HBM	Human Body Model
MM	Machine Model

## 15. Revision history

Table 12. Revision history

Document ID	Release date	Data sheet status	Change notice	Supersedes
XC7SET02_1	20090831	Product data sheet	-	-

## 16. Legal information

### 16.1 Data sheet status

Document status <sup>[1][2]</sup>	Product status <sup>[3]</sup>	Definition
Objective [short] data sheet	Development	This document contains data from the objective specification for product development.
Preliminary [short] data sheet	Qualification	This document contains data from the preliminary specification.
Product [short] data sheet	Production	This document contains the product specification.

[1] Please consult the most recently issued document before initiating or completing a design.

[2] The term 'short data sheet' is explained in section "Definitions".

[3] The product status of device(s) described in this document may have changed since this document was published and may differ in case of multiple devices. The latest product status information is available on the Internet at URL <http://www.nexperia.com>.

### 16.2 Definitions

**Draft** — The document is a draft version only. The content is still under internal review and subject to formal approval, which may result in modifications or additions. Nexperia does not give any representations or warranties as to the accuracy or completeness of information included herein and shall have no liability for the consequences of use of such information.

**Short data sheet** — A short data sheet is an extract from a full data sheet with the same product type number(s) and title. A short data sheet is intended for quick reference only and should not be relied upon to contain detailed and full information. For detailed and full information see the relevant full data sheet, which is available on request via the local Nexperia sales office. In case of any inconsistency or conflict with the short data sheet, the full data sheet shall prevail.

### 16.3 Disclaimers

**General** — Information in this document is believed to be accurate and reliable. However, Nexperia does not give any representations or warranties, expressed or implied, as to the accuracy or completeness of such information and shall have no liability for the consequences of use of such information.

**Right to make changes** — Nexperia reserves the right to make changes to information published in this document, including without limitation specifications and product descriptions, at any time and without notice. This document supersedes and replaces all information supplied prior to the publication hereof.

**Suitability for use** — Nexperia products are not designed, authorized or warranted to be suitable for use in medical, military, aircraft, space or life support equipment, nor in applications where failure or malfunction of a Nexperia product can reasonably be expected to result in personal injury, death or severe property or environmental

damage. Nexperia accepts no liability for inclusion and/or use of Nexperia products in such equipment or applications and therefore such inclusion and/or use is at the customer's own risk.

**Applications** — Applications that are described herein for any of these products are for illustrative purposes only. Nexperia makes no representation or warranty that such applications will be suitable for the specified use without further testing or modification.

**Limiting values** — Stress above one or more limiting values (as defined in the Absolute Maximum Ratings System of IEC 60134) may cause permanent damage to the device. Limiting values are stress ratings only and operation of the device at these or any other conditions above those given in the Characteristics sections of this document is not implied. Exposure to limiting values for extended periods may affect device reliability.

**Terms and conditions of sale** — Nexperia products are sold subject to the general terms and conditions of commercial sale, as published at <http://www.nexperia.com/profile/terms>, including those pertaining to warranty, intellectual property rights infringement and limitation of liability, unless explicitly otherwise agreed to in writing by Nexperia. In case of any inconsistency or conflict between information in this document and such terms and conditions, the latter will prevail.

**No offer to sell or license** — Nothing in this document may be interpreted or construed as an offer to sell products that is open for acceptance or the grant, conveyance or implication of any license under any copyrights, patents or other industrial or intellectual property rights.

**Export control** — This document as well as the item(s) described herein may be subject to export control regulations. Export might require a prior authorization from national authorities.

### 16.4 Trademarks

Notice: All referenced brands, product names, service names and trademarks are the property of their respective owners.

## 17. Contact information

For more information, please visit: <http://www.nexperia.com>

For sales office addresses, please send an email to: [salesaddresses@nexperia.com](mailto:salesaddresses@nexperia.com)

## 18. Contents

---

<b>1</b>	<b>General description</b> .....	<b>1</b>
<b>2</b>	<b>Features</b> .....	<b>1</b>
<b>3</b>	<b>Ordering information</b> .....	<b>1</b>
<b>4</b>	<b>Marking</b> .....	<b>2</b>
<b>5</b>	<b>Functional diagram</b> .....	<b>2</b>
<b>6</b>	<b>Pinning information</b> .....	<b>2</b>
6.1	Pinning .....	2
6.2	Pin description .....	2
<b>7</b>	<b>Functional description</b> .....	<b>3</b>
<b>8</b>	<b>Limiting values</b> .....	<b>3</b>
<b>9</b>	<b>Recommended operating conditions</b> .....	<b>4</b>
<b>10</b>	<b>Static characteristics</b> .....	<b>4</b>
<b>11</b>	<b>Dynamic characteristics</b> .....	<b>5</b>
<b>12</b>	<b>Waveforms</b> .....	<b>6</b>
<b>13</b>	<b>Package outline</b> .....	<b>7</b>
<b>14</b>	<b>Abbreviations</b> .....	<b>9</b>
<b>15</b>	<b>Revision history</b> .....	<b>9</b>
<b>16</b>	<b>Legal information</b> .....	<b>10</b>
16.1	Data sheet status .....	10
16.2	Definitions .....	10
16.3	Disclaimers .....	10
16.4	Trademarks .....	10
<b>17</b>	<b>Contact information</b> .....	<b>10</b>
<b>18</b>	<b>Contents</b> .....	<b>11</b>

单击下面可查看定价，库存，交付和生命周期等信息

[>>Nexperia\(安世\)](#)