



Is Now Part of



ON Semiconductor®

To learn more about ON Semiconductor, please visit our website at
www.onsemi.com

Please note: As part of the Fairchild Semiconductor integration, some of the Fairchild orderable part numbers will need to change in order to meet ON Semiconductor's system requirements. Since the ON Semiconductor product management systems do not have the ability to manage part nomenclature that utilizes an underscore (_), the underscore (_) in the Fairchild part numbers will be changed to a dash (-). This document may contain device numbers with an underscore (_). Please check the ON Semiconductor website to verify the updated device numbers. The most current and up-to-date ordering information can be found at www.onsemi.com. Please email any questions regarding the system integration to Fairchild_questions@onsemi.com.

ON Semiconductor and the ON Semiconductor logo are trademarks of Semiconductor Components Industries, LLC dba ON Semiconductor or its subsidiaries in the United States and/or other countries. ON Semiconductor owns the rights to a number of patents, trademarks, copyrights, trade secrets, and other intellectual property. A listing of ON Semiconductor's product/patent coverage may be accessed at www.onsemi.com/site/pdf/Patent-Marking.pdf. ON Semiconductor reserves the right to make changes without further notice to any products herein. ON Semiconductor makes no warranty, representation or guarantee regarding the suitability of its products for any particular purpose, nor does ON Semiconductor assume any liability arising out of the application or use of any product or circuit, and specifically disclaims any and all liability, including without limitation special, consequential or incidental damages. Buyer is responsible for its products and applications using ON Semiconductor products, including compliance with all laws, regulations and safety requirements or standards, regardless of any support or applications information provided by ON Semiconductor. "Typical" parameters which may be provided in ON Semiconductor data sheets and/or specifications can and do vary in different applications and actual performance may vary over time. All operating parameters, including "Typicals" must be validated for each customer application by customer's technical experts. ON Semiconductor does not convey any license under its patent rights nor the rights of others. ON Semiconductor products are not designed, intended, or authorized for use as a critical component in life support systems or any FDA Class 3 medical devices or medical devices with a same or similar classification in a foreign jurisdiction or any devices intended for implantation in the human body. Should Buyer purchase or use ON Semiconductor products for any such unintended or unauthorized application, Buyer shall indemnify and hold ON Semiconductor and its officers, employees, subsidiaries, affiliates, and distributors harmless against all claims, costs, damages, and expenses, and reasonable attorney fees arising out of, directly or indirectly, any claim of personal injury or death associated with such unintended or unauthorized use, even if such claim alleges that ON Semiconductor was negligent regarding the design or manufacture of the part. ON Semiconductor is an Equal Opportunity/Affirmative Action Employer. This literature is subject to all applicable copyright laws and is not for resale in any manner.

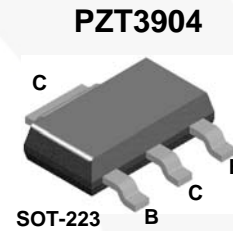
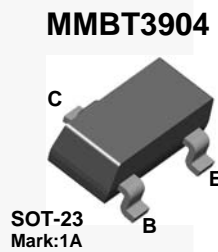
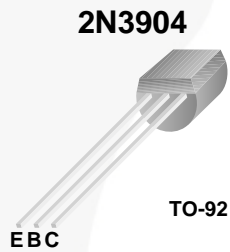


October 2014

2N3904 / MMBT3904 / PZT3904 NPN General-Purpose Amplifier

Description

This device is designed as a general-purpose amplifier and switch. The useful dynamic range extends to 100 mA as a switch and to 100 MHz as an amplifier.



Ordering Information

Part Number	Marking	Package	Packing Method	Pack Quantity
2N3904BU	2N3904	TO-92 3L	Bulk	10000
2N3904TA	2N3904	TO-92 3L	Ammo	2000
2N3904TAR	2N3904	TO-92 3L	Ammo	2000
2N3904TF	2N3904	TO-92 3L	Tape and Reel	2000
2N3904TFR	2N3904	TO-92 3L	Tape and Reel	2000
MMBT3904	1A	SOT-23 3L	Tape and Reel	3000
PZT3904	3904	SOT-223 4L	Tape and Reel	2500

2N3904 / MMBT3904 / PZT3904 — NPN General-Purpose Amplifier

Absolute Maximum Ratings^{(1), (2)}

Stresses exceeding the absolute maximum ratings may damage the device. The device may not function or be operable above the recommended operating conditions and stressing the parts to these levels is not recommended. In addition, extended exposure to stresses above the recommended operating conditions may affect device reliability. The absolute maximum ratings are stress ratings only. Values are at $T_A = 25^\circ\text{C}$ unless otherwise noted.

Symbol	Parameter	Value	Unit
V_{CEO}	Collector-Emitter Voltage	40	V
V_{CBO}	Collector-Base Voltage	60	V
V_{EBO}	Emitter-Base Voltage	6.0	V
I_C	Collector Current - Continuous	200	mA
T_J, T_{STG}	Operating and Storage Junction Temperature Range	-55 to 150	$^\circ\text{C}$

Notes:

1. These ratings are based on a maximum junction temperature of 150°C .
2. These are steady-state limits. Fairchild Semiconductor should be consulted on applications involving pulsed or low-duty cycle operations.

Thermal Characteristics

Values are at $T_A = 25^\circ\text{C}$ unless otherwise noted.

Symbol	Parameter	Maximum			Unit
		2N3904	MMBT3904 ⁽³⁾	PZT3904 ⁽⁴⁾	
P_D	Total Device Dissipation	625	350	1,000	mW
	Derate Above 25°C	5.0	2.8	8.0	$\text{mW}/^\circ\text{C}$
$R_{\theta JC}$	Thermal Resistance, Junction to Case	83.3			$^\circ\text{C}/\text{W}$
$R_{\theta JA}$	Thermal Resistance, Junction to Ambient	200	357	125	$^\circ\text{C}/\text{W}$

Notes:

3. Device is mounted on FR-4 PCB 1.6 inch X 1.6 inch X 0.06 inch.
4. Device is mounted on FR-4 PCB 36 mm X 18 mm X 1.5 mm, mounting pad for the collector lead minimum 6 cm^2 .

Electrical Characteristics

Values are at $T_A = 25^\circ\text{C}$ unless otherwise noted.

Symbol	Parameter	Conditions	Min.	Max.	Unit
OFF CHARACTERISTICS					
$V_{(BR)CEO}$	Collector-Emitter Breakdown Voltage	$I_C = 1.0\text{ mA}, I_B = 0$	40		V
$V_{(BR)CBO}$	Collector-Base Breakdown Voltage	$I_C = 10\text{ }\mu\text{A}, I_E = 0$	60		V
$V_{(BR)EBO}$	Emitter-Base Breakdown Voltage	$I_E = 10\text{ }\mu\text{A}, I_C = 0$	6.0		V
I_{BL}	Base Cut-Off Current	$V_{CE} = 30\text{ V}, V_{EB} = 3\text{ V}$		50	nA
I_{CEX}	Collector Cut-Off Current	$V_{CE} = 30\text{ V}, V_{EB} = 3\text{ V}$		50	nA
ON CHARACTERISTICS⁽⁵⁾					
h_{FE}	DC Current Gain	$I_C = 0.1\text{ mA}, V_{CE} = 1.0\text{ V}$	40		
		$I_C = 1.0\text{ mA}, V_{CE} = 1.0\text{ V}$	70		
		$I_C = 10\text{ mA}, V_{CE} = 1.0\text{ V}$	100	300	
		$I_C = 50\text{ mA}, V_{CE} = 1.0\text{ V}$	60		
		$I_C = 100\text{ mA}, V_{CE} = 1.0\text{ V}$	30		
$V_{CE(sat)}$	Collector-Emitter Saturation Voltage	$I_C = 10\text{ mA}, I_B = 1.0\text{ mA}$		0.2	V
		$I_C = 50\text{ mA}, I_B = 5.0\text{ mA}$		0.3	
$V_{BE(sat)}$	Base-Emitter Saturation Voltage	$I_C = 10\text{ mA}, I_B = 1.0\text{ mA}$	0.65	0.85	V
		$I_C = 50\text{ mA}, I_B = 5.0\text{ mA}$		0.95	
SMALL SIGNAL CHARACTERISTICS					
f_T	Current Gain - Bandwidth Product	$I_C = 10\text{ mA}, V_{CE} = 20\text{ V},$ $f = 100\text{ MHz}$	300		MHz
C_{obo}	Output Capacitance	$V_{CB} = 5.0\text{ V}, I_E = 0,$ $f = 100\text{ kHz}$		4.0	pF
C_{ibo}	Input Capacitance	$V_{EB} = 0.5\text{ V}, I_C = 0,$ $f = 100\text{ kHz}$		8.0	pF
NF	Noise Figure	$I_C = 100\text{ }\mu\text{A}, V_{CE} = 5.0\text{ V},$ $R_S = 1.0\text{ k}\Omega,$ $f = 10\text{ Hz to }15.7\text{ kHz}$		5.0	dB
SWITCHING CHARACTERISTICS					
t_d	Delay Time	$V_{CC} = 3.0\text{ V}, V_{BE} = 0.5\text{ V}$		35	ns
t_r	Rise Time	$I_C = 10\text{ mA}, I_{B1} = 1.0\text{ mA}$		35	ns
t_s	Storage Time	$V_{CC} = 3.0\text{ V}, I_C = 10\text{ mA},$		200	ns
t_f	Fall Time	$I_{B1} = I_{B2} = 1.0\text{ mA}$		50	ns

Note:

5. Pulse test: pulse width $\leq 300\text{ }\mu\text{s}$, duty cycle $\leq 2.0\%$.

Typical Performance Characteristics



Figure 1. Typical Pulsed Current Gain vs. Collector Current



Figure 2. Collector-Emitter Saturation Voltage vs. Collector Current

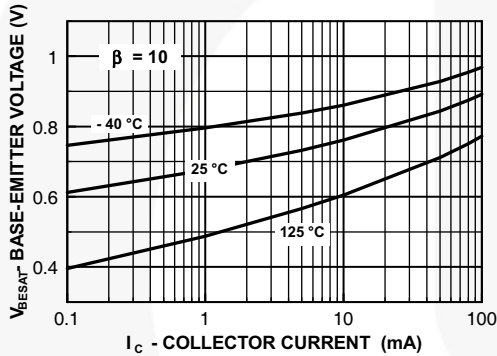


Figure 3. Base-Emitter Saturation Voltage vs. Collector Current

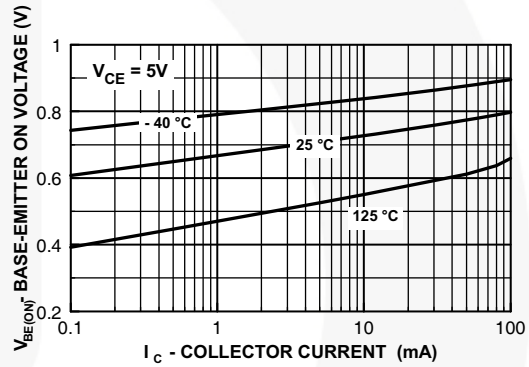


Figure 4. Base-Emitter On Voltage vs. Collector Current

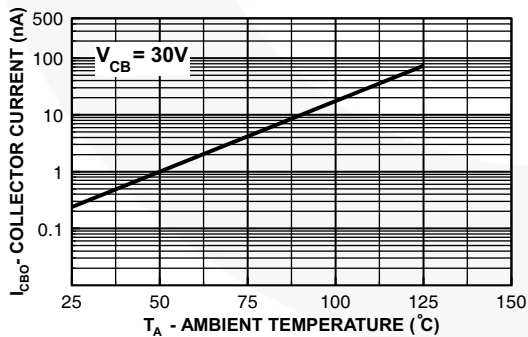


Figure 5. Collector Cut-Off Current vs. Ambient Temperature

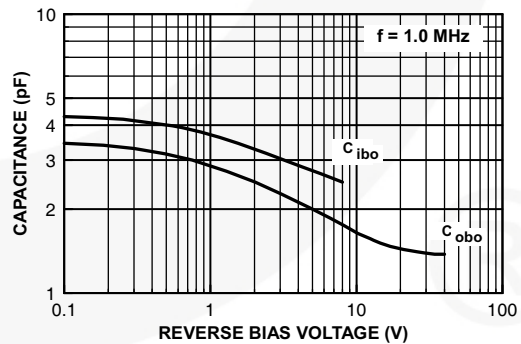


Figure 6. Capacitance vs. Reverse Bias Voltage

Typical Performance Characteristics (Continued)

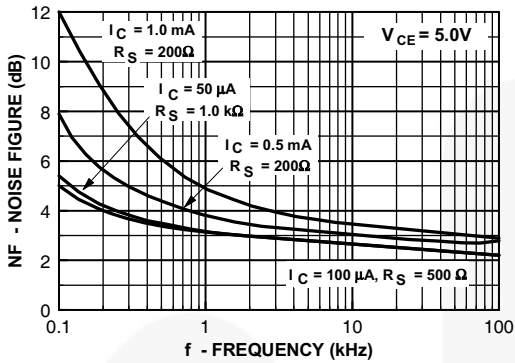


Figure 7. Noise Figure vs. Frequency

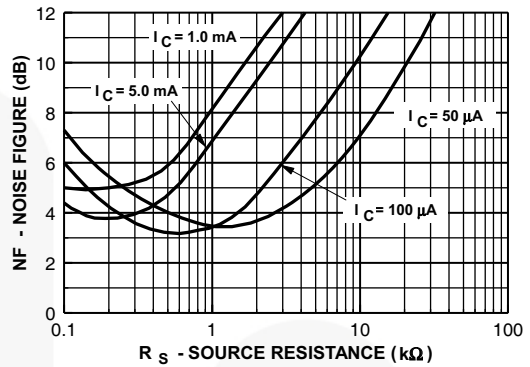


Figure 8. Noise Figure vs. Source Resistance

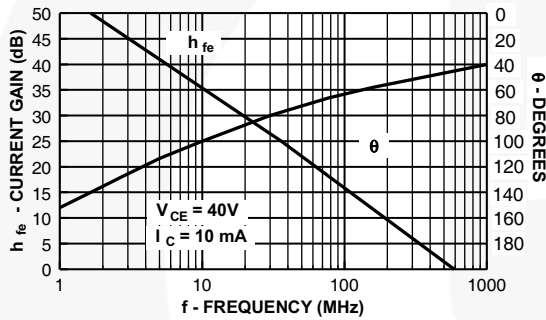


Figure 9. Current Gain and Phase Angle vs. Frequency

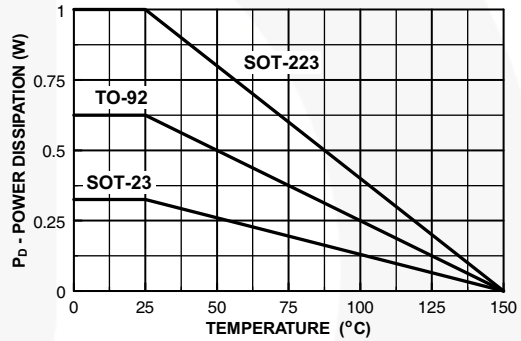


Figure 10. Power Dissipation vs. Ambient Temperature

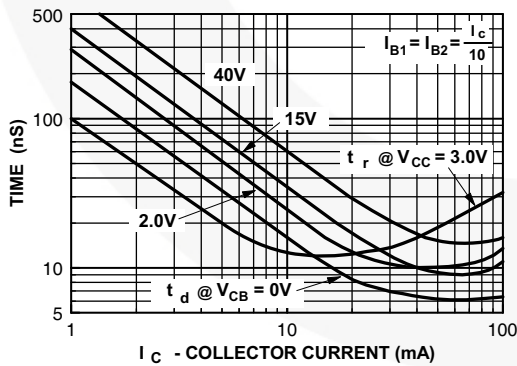


Figure 11. Turn-On Time vs. Collector Current

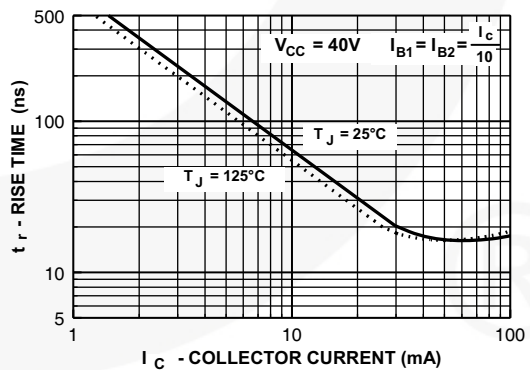


Figure 12. Rise Time vs. Collector Current

Typical Performance Characteristics (Continued)

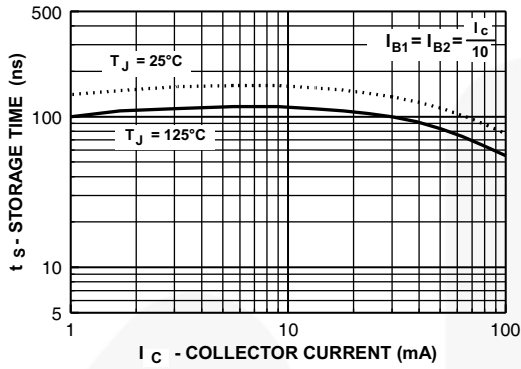


Figure 13. Storage Time vs. Collector Current

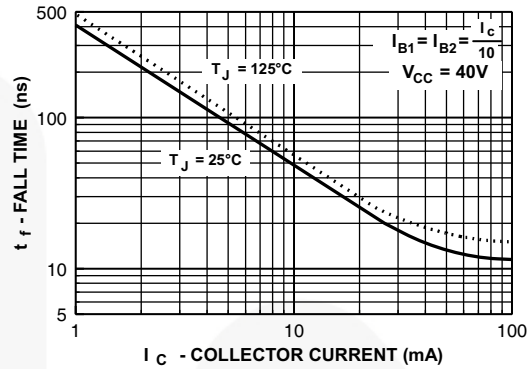


Figure 14. Fall Time vs. Collector Current

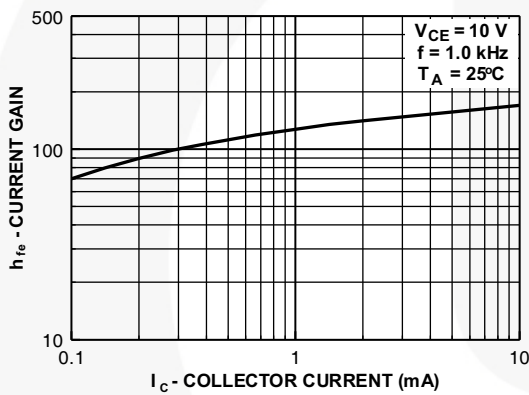


Figure 15. Current Gain

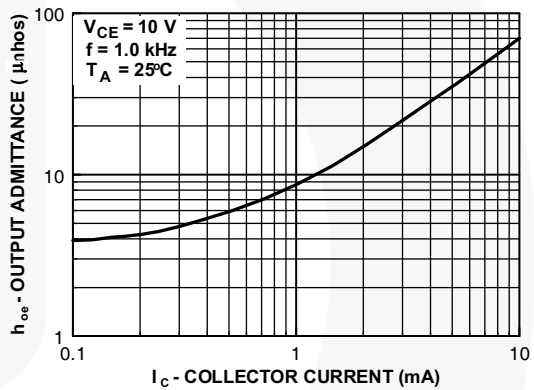


Figure 16. Output Admittance

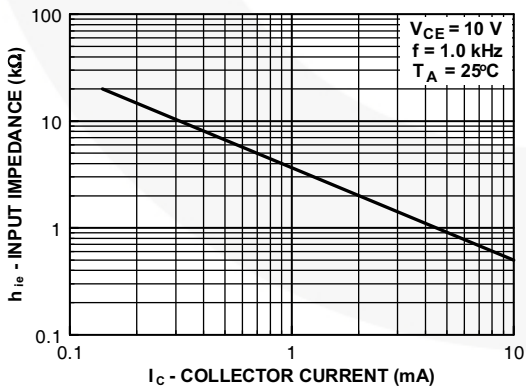


Figure 17. Input Impedance

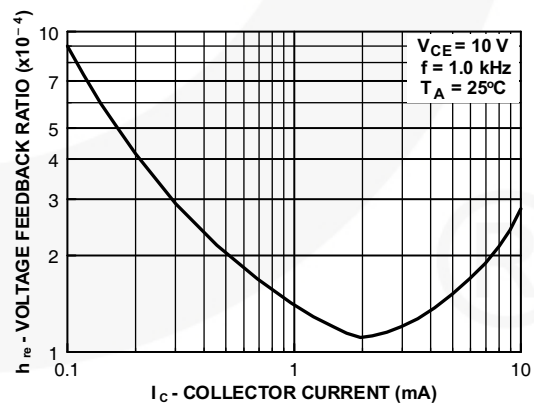


Figure 18. Voltage Feedback Ratio

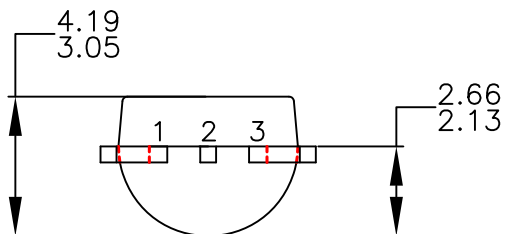
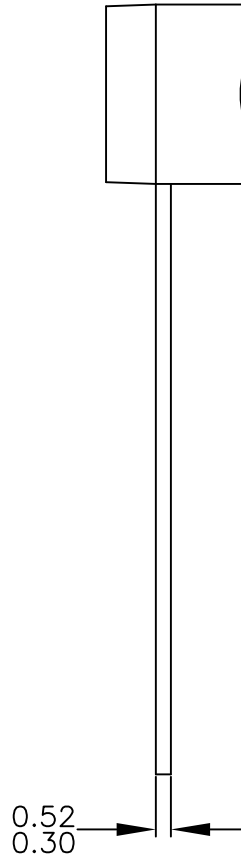
Test Circuits



Figure 19. Delay and Rise Time Equivalent Test Circuit

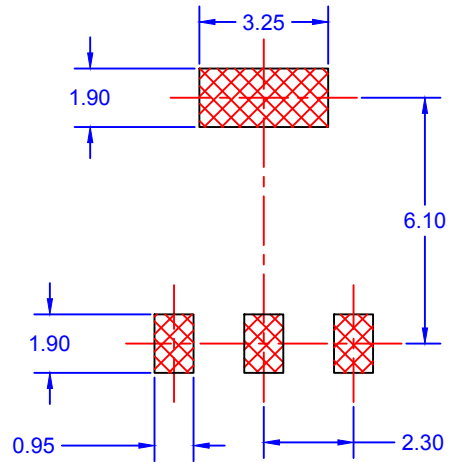


Figure 20. Storage and Fall Time Equivalent Test Circuit

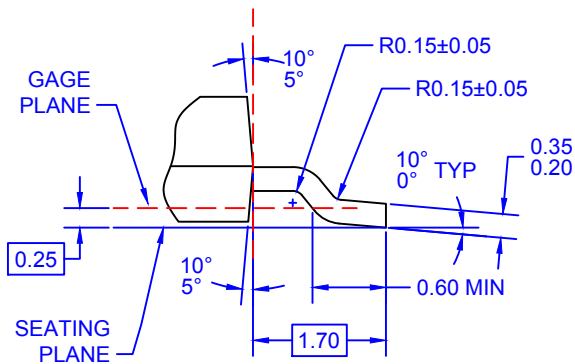
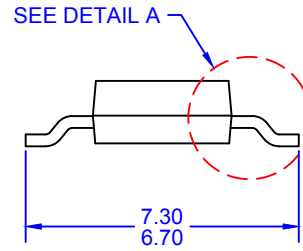
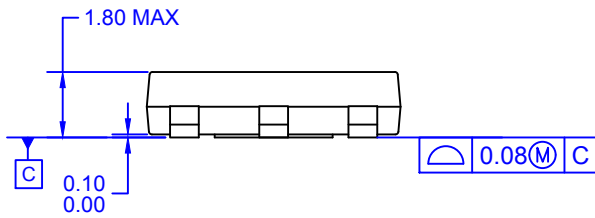


NOTES: UNLESS OTHERWISE SPECIFIED

- A. DRAWING CONFORMS TO JEDEC MS-013, VARIATION AC.
- B. ALL DIMENSIONS ARE IN MILLIMETERS.
- C. DRAWING CONFORMS TO ASME Y14.5M-2009.
- D. DRAWING FILENAME: MKT-ZA03FREV3.
- E. FAIRCHILD SEMICONDUCTOR.



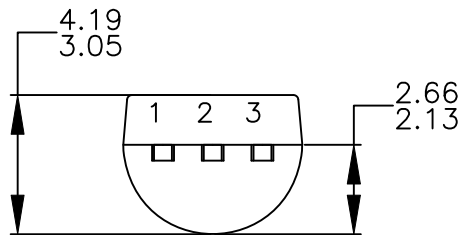
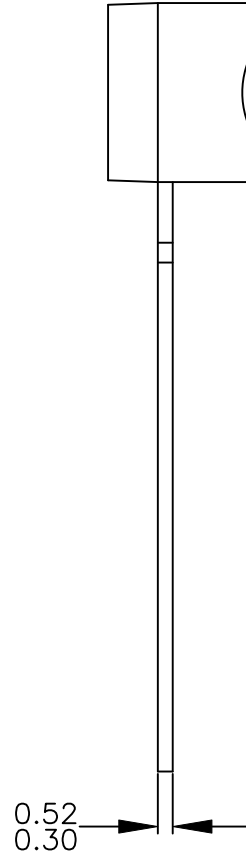
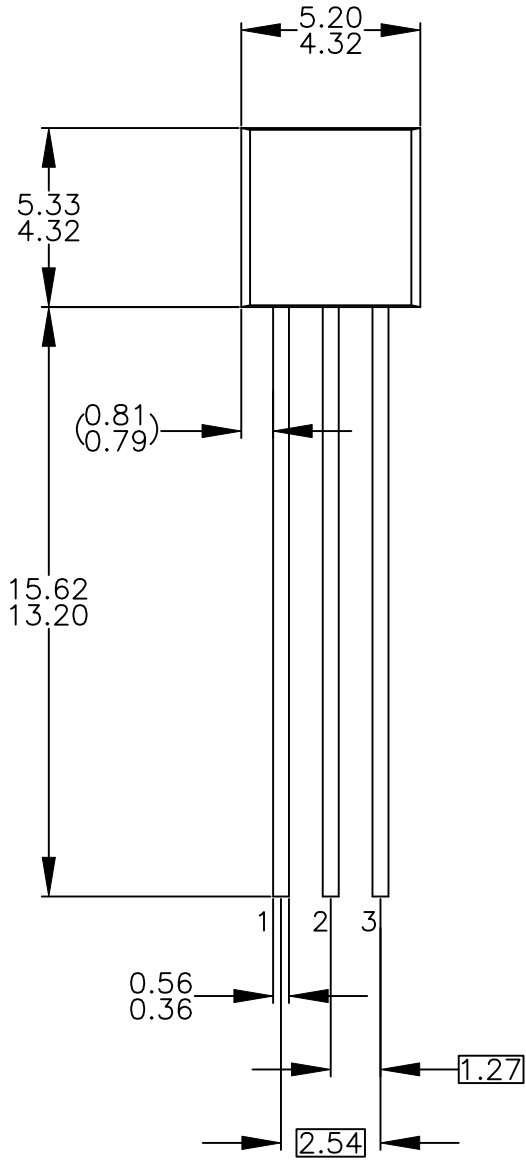
LAND PATTERN RECOMMENDATION



DETAIL A
SCALE: 2:1

- NOTES: UNLESS OTHERWISE SPECIFIED
 A) DRAWING BASED ON JEDEC REGISTRATION TO-261C, VARIATION AA.
 B) ALL DIMENSIONS ARE IN MILLIMETERS.
 C) DIMENSIONS DO NOT INCLUDE BURRS OR MOLD FLASH. MOLD FLASH OR BURRS DOES NOT EXCEED 0.10MM.
 D) DIMENSIONING AND TOLERANCING PER ASME Y14.5M-2009.
 E) LANDPATTERN NAME: SOT230P700X180-4BN
 F) DRAWING FILENAME: MKT-MA04AREV3

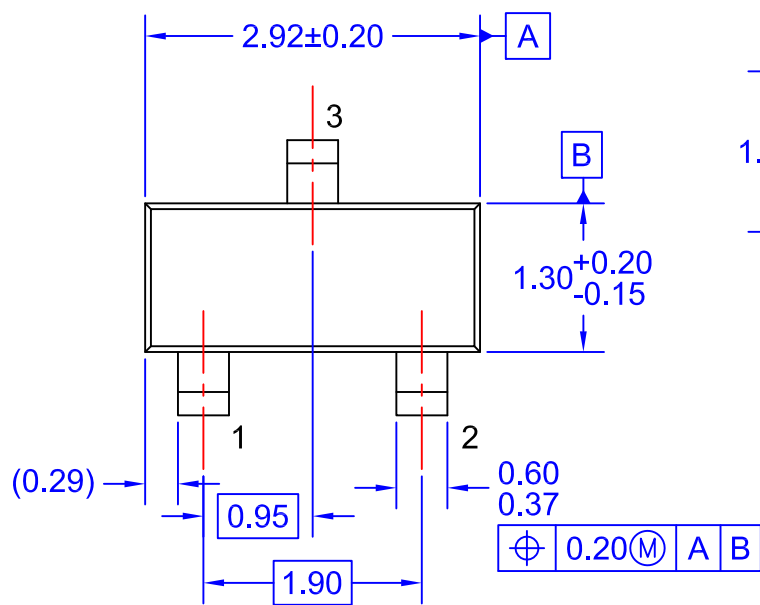




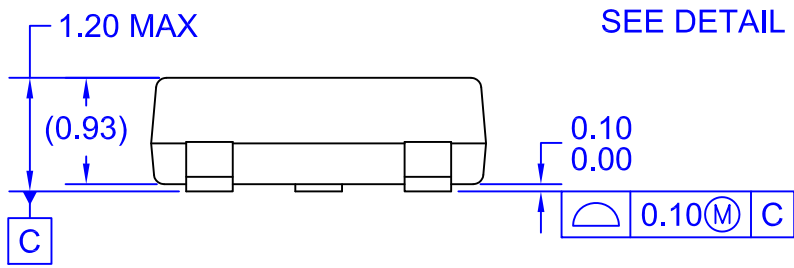
NOTES: UNLESS OTHERWISE SPECIFIED

- A) DRAWING WITH REFERENCE TO JEDEC TO-92 RECOMMENDATIONS.
- B) ALL DIMENSIONS ARE IN MILLIMETERS.
- C) DRAWING CONFORMS TO ASME Y14.5M-2009.
- D) DRAWING FILENAME: MKT-ZA03DREV4.





LAND PATTERN
RECOMMENDATION



SEE DETAIL A



DETAIL A
SCALE: 2X

NOTES: UNLESS OTHERWISE SPECIFIED

- A) REFERENCE JEDEC REGISTRATION TO-236, VARIATION AB, ISSUE H.
- B) ALL DIMENSIONS ARE IN MILLIMETERS.
- C) DIMENSIONS ARE INCLUSIVE OF BURRS, MOLD FLASH AND TIE BAR EXTRUSIONS.
- D) DIMENSIONING AND TOLERANCING PER ASME Y14.5M - 2009.
- E) DRAWING FILE NAME: MA03DREV12



ON Semiconductor and  are trademarks of Semiconductor Components Industries, LLC dba ON Semiconductor or its subsidiaries in the United States and/or other countries. ON Semiconductor owns the rights to a number of patents, trademarks, copyrights, trade secrets, and other intellectual property. A listing of ON Semiconductor's product/patent coverage may be accessed at www.onsemi.com/site/pdf/Patent-Marking.pdf. ON Semiconductor reserves the right to make changes without further notice to any products herein. ON Semiconductor makes no warranty, representation or guarantee regarding the suitability of its products for any particular purpose, nor does ON Semiconductor assume any liability arising out of the application or use of any product or circuit, and specifically disclaims any and all liability, including without limitation special, consequential or incidental damages. Buyer is responsible for its products and applications using ON Semiconductor products, including compliance with all laws, regulations and safety requirements or standards, regardless of any support or applications information provided by ON Semiconductor. "Typical" parameters which may be provided in ON Semiconductor data sheets and/or specifications can and do vary in different applications and actual performance may vary over time. All operating parameters, including "Typicals" must be validated for each customer application by customer's technical experts. ON Semiconductor does not convey any license under its patent rights nor the rights of others. ON Semiconductor products are not designed, intended, or authorized for use as a critical component in life support systems or any FDA Class 3 medical devices or medical devices with a same or similar classification in a foreign jurisdiction or any devices intended for implantation in the human body. Should Buyer purchase or use ON Semiconductor products for any such unintended or unauthorized application, Buyer shall indemnify and hold ON Semiconductor and its officers, employees, subsidiaries, affiliates, and distributors harmless against all claims, costs, damages, and expenses, and reasonable attorney fees arising out of, directly or indirectly, any claim of personal injury or death associated with such unintended or unauthorized use, even if such claim alleges that ON Semiconductor was negligent regarding the design or manufacture of the part. ON Semiconductor is an Equal Opportunity/Affirmative Action Employer. This literature is subject to all applicable copyright laws and is not for resale in any manner.

PUBLICATION ORDERING INFORMATION

LITERATURE FULFILLMENT:

Literature Distribution Center for ON Semiconductor
19521 E. 32nd Pkwy, Aurora, Colorado 80011 USA
Phone: 303-675-2175 or 800-344-3860 Toll Free USA/Canada
Fax: 303-675-2176 or 800-344-3867 Toll Free USA/Canada
Email: orderlit@onsemi.com

N. American Technical Support: 800-282-9855 Toll Free
USA/Canada
Europe, Middle East and Africa Technical Support:
Phone: 421 33 790 2910
Japan Customer Focus Center
Phone: 81-3-5817-1050

ON Semiconductor Website: www.onsemi.com
Order Literature: <http://www.onsemi.com/orderlit>
For additional information, please contact your local
Sales Representative

单击下面可查看定价，库存，交付和生命周期等信息

[>>ON Semiconductor\(安森美\)](#)