

TIP120, TIP121, TIP122 (NPN); TIP125, TIP126, TIP127 (PNP)

Plastic Medium-Power Complementary Silicon Transistors

Designed for general-purpose amplifier and low-speed switching applications.

Features

- High DC Current Gain –
 $h_{FE} = 2500$ (Typ) @ $I_C = 4.0$ Adc
- Collector–Emitter Sustaining Voltage – @ 100 mAdc
 $V_{CE(sus)} = 60$ Vdc (Min) – TIP120, TIP125
 $= 80$ Vdc (Min) – TIP121, TIP126
 $= 100$ Vdc (Min) – TIP122, TIP127
- Low Collector–Emitter Saturation Voltage –
 $V_{CE(sat)} = 2.0$ Vdc (Max) @ $I_C = 3.0$ Adc
 $= 4.0$ Vdc (Max) @ $I_C = 5.0$ Adc
- Monolithic Construction with Built–In Base–Emitter Shunt Resistors
- Pb–Free Packages are Available*



ON Semiconductor®

www.onsemi.com

DARLINGTON 5 AMPERE COMPLEMENTARY SILICON POWER TRANSISTORS 60–80–100 VOLTS, 65 WATTS

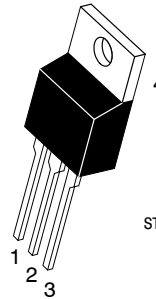

TO-220AB
CASE 221A
STYLE 1

STYLE 1:
PIN 1. BASE
2. COLLECTOR
3. EMITTER
4. COLLECTOR

MARKING DIAGRAM



TIP12x = Device Code
x = 0, 1, 2, 5, 6, or 7
A = Assembly Location
Y = Year
WW = Work Week
G = Pb–Free Package

ORDERING INFORMATION

See detailed ordering and shipping information on page 3 of this data sheet.

*For additional information on our Pb–Free strategy and soldering details, please download the ON Semiconductor Soldering and Mounting Techniques Reference Manual, SOLDERRM/D.

TIP120, TIP121, TIP122 (NPN); TIP125, TIP126, TIP127 (PNP)

MAXIMUM RATINGS

Rating	Symbol	TIP120, TIP125	TIP121, TIP126	TIP122, TIP127	Unit
Collector–Emitter Voltage	V_{CEO}	60	80	100	Vdc
Collector–Base Voltage	V_{CB}	60	80	100	Vdc
Emitter–Base Voltage	V_{EB}	5.0			Vdc
Collector Current – Continuous – Peak	I_C	5.0 8.0			Adc
Base Current	I_B	120			mAdc
Total Power Dissipation @ $T_C = 25^\circ\text{C}$ Derate above 25°C	P_D	65 0.52			W W/ $^\circ\text{C}$
Total Power Dissipation @ $T_A = 25^\circ\text{C}$ Derate above 25°C	P_D	2.0 0.016			W W/ $^\circ\text{C}$
Unclamped Inductive Load Energy (Note 1)	E	50			mJ
Operating and Storage Junction, Temperature Range	T_J, T_{stg}	–65 to +150			$^\circ\text{C}$

THERMAL CHARACTERISTICS

Characteristic	Symbol	Max	Unit
Thermal Resistance, Junction–to–Case	$R_{\theta JC}$	1.92	$^\circ\text{C}/\text{W}$
Thermal Resistance, Junction–to–Ambient	$R_{\theta JA}$	62.5	$^\circ\text{C}/\text{W}$

Stresses exceeding those listed in the Maximum Ratings table may damage the device. If any of these limits are exceeded, device functionality should not be assumed, damage may occur and reliability may be affected.

1. $I_C = 1\text{ A}$, $L = 100\text{ mH}$, P.R.F. = 10 Hz, $V_{CC} = 20\text{ V}$, $R_{BE} = 100\ \Omega$

ELECTRICAL CHARACTERISTICS ($T_C = 25^\circ\text{C}$ unless otherwise noted)

Characteristic	Symbol	Min	Max	Unit
----------------	--------	-----	-----	------

OFF CHARACTERISTICS

Collector–Emitter Sustaining Voltage (Note 2) ($I_C = 100\text{ mAdc}$, $I_B = 0$)	TIP120, TIP125 TIP121, TIP126 TIP122, TIP127	$V_{CEO(sus)}$	60 80 100	– – –	Vdc
Collector Cutoff Current ($V_{CE} = 30\text{ Vdc}$, $I_B = 0$) ($V_{CE} = 40\text{ Vdc}$, $I_B = 0$) ($V_{CE} = 50\text{ Vdc}$, $I_B = 0$)	TIP120, TIP125 TIP121, TIP126 TIP122, TIP127	I_{CEO}	– – –	0.5 0.5 0.5	mAdc
Collector Cutoff Current ($V_{CB} = 60\text{ Vdc}$, $I_E = 0$) ($V_{CB} = 80\text{ Vdc}$, $I_E = 0$) ($V_{CB} = 100\text{ Vdc}$, $I_E = 0$)	TIP120, TIP125 TIP121, TIP126 TIP122, TIP127	I_{CBO}	– – –	0.2 0.2 0.2	mAdc
Emitter Cutoff Current ($V_{BE} = 5.0\text{ Vdc}$, $I_C = 0$)		I_{EBO}	–	2.0	mAdc

ON CHARACTERISTICS (Note 2)

DC Current Gain ($I_C = 0.5\text{ Adc}$, $V_{CE} = 3.0\text{ Vdc}$) ($I_C = 3.0\text{ Adc}$, $V_{CE} = 3.0\text{ Vdc}$)		h_{FE}	1000 1000	– –	–
Collector–Emitter Saturation Voltage ($I_C = 3.0\text{ Adc}$, $I_B = 12\text{ mAdc}$) ($I_C = 5.0\text{ Adc}$, $I_B = 20\text{ mAdc}$)		$V_{CE(sat)}$	– –	2.0 4.0	Vdc
Base–Emitter On Voltage ($I_C = 3.0\text{ Adc}$, $V_{CE} = 3.0\text{ Vdc}$)		$V_{BE(on)}$	–	2.5	Vdc

DYNAMIC CHARACTERISTICS

Small–Signal Current Gain ($I_C = 3.0\text{ Adc}$, $V_{CE} = 4.0\text{ Vdc}$, $f = 1.0\text{ MHz}$)		h_{fe}	4.0	–	–
Output Capacitance ($V_{CB} = 10\text{ Vdc}$, $I_E = 0$, $f = 0.1\text{ MHz}$)	TIP125, TIP126, TIP127 TIP120, TIP121, TIP122	C_{ob}	– –	300 200	pF

Product parametric performance is indicated in the Electrical Characteristics for the listed test conditions, unless otherwise noted. Product performance may not be indicated by the Electrical Characteristics if operated under different conditions.

2. Pulse Test: Pulse Width $\leq 300\ \mu\text{s}$, Duty Cycle $\leq 2\%$

TIP120, TIP121, TIP122 (NPN); TIP125, TIP126, TIP127 (PNP)



Figure 1. Darlington Circuit Schematic

ORDERING INFORMATION

Device	Package	Shipping
TIP120	TO-220	50 Units / Rail
TIP120G	TO-220 (Pb-Free)	50 Units / Rail
TIP121	TO-220	50 Units / Rail
TIP121G	TO-220 (Pb-Free)	50 Units / Rail
TIP122	TO-220	50 Units / Rail
TIP122G	TO-220 (Pb-Free)	50 Units / Rail
TIP125	TO-220	50 Units / Rail
TIP125G	TO-220 (Pb-Free)	50 Units / Rail
TIP126	TO-220	50 Units / Rail
TIP126G	TO-220 (Pb-Free)	50 Units / Rail
TIP127	TO-220	50 Units / Rail
TIP127G	TO-220 (Pb-Free)	50 Units / Rail



Figure 2. Power Derating

TIP120, TIP121, TIP122 (NPN); TIP125, TIP126, TIP127 (PNP)

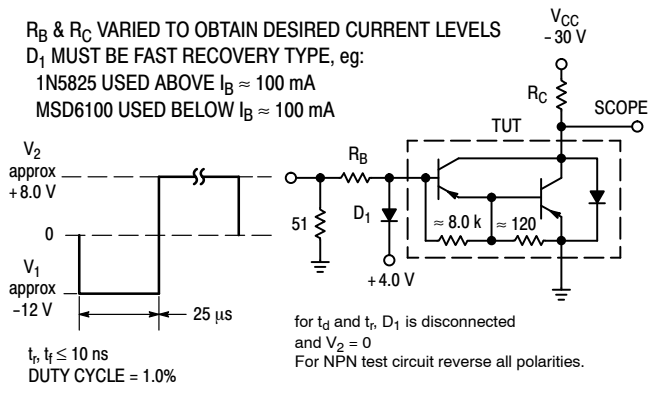

Figure 3. Switching Times Test Circuit



Figure 4. Switching Times

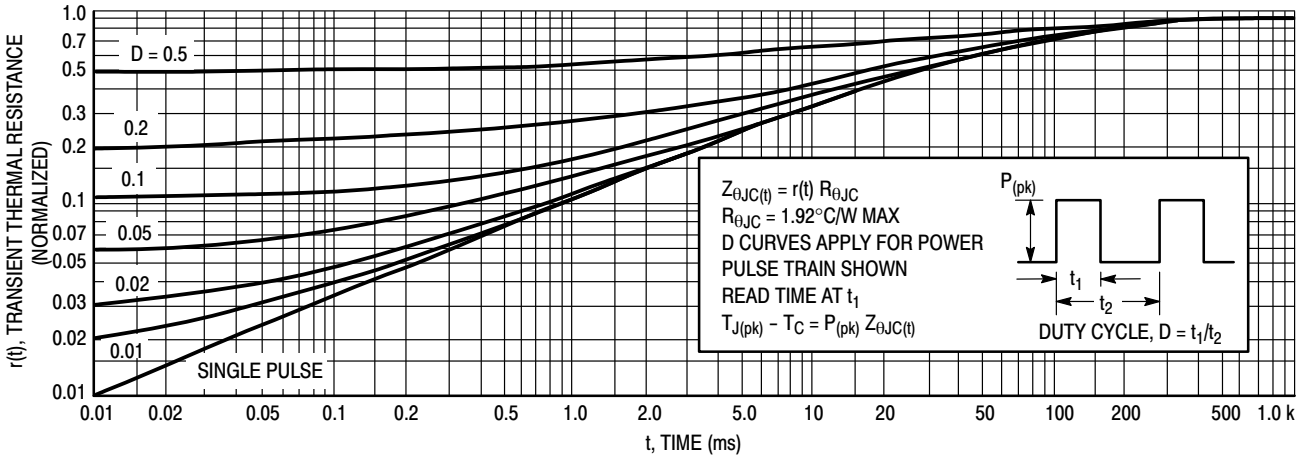

Figure 5. Thermal Response

TIP120, TIP121, TIP122 (NPN); TIP125, TIP126, TIP127 (PNP)

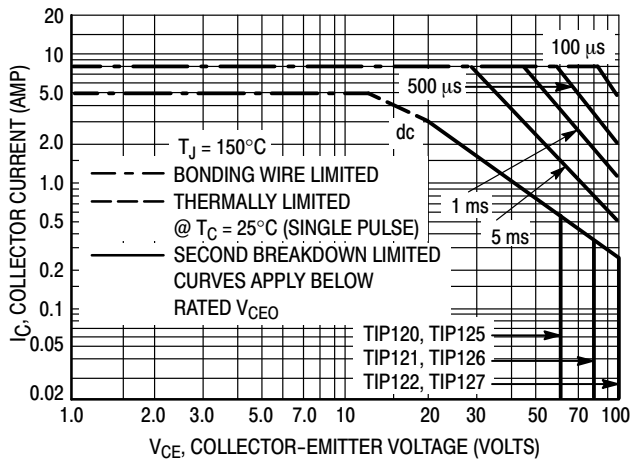

Figure 6. Active-Region Safe Operating Area

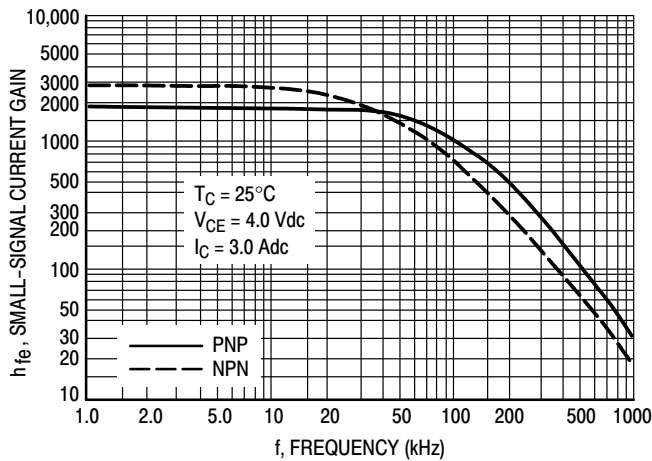

Figure 7. Small-Signal Current Gain

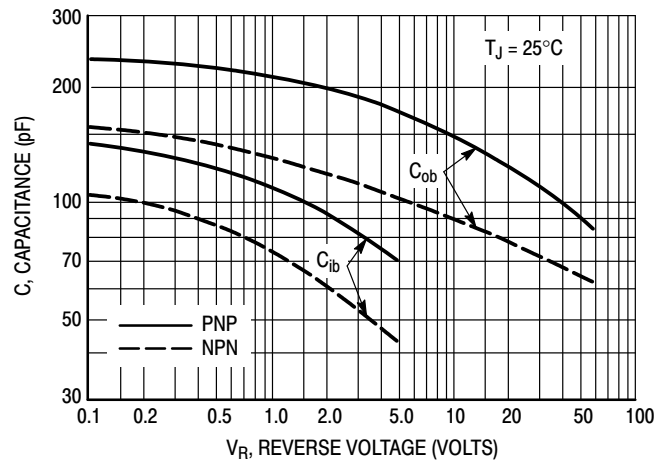

Figure 8. Capacitance

There are two limitations on the power handling ability of a transistor: average junction temperature and second breakdown. Safe operating area curves indicate $I_C - V_{CE}$ limits of the transistor that must be observed for reliable operation, i.e., the transistor must not be subjected to greater dissipation than the curves indicate.

The data of Figure 6 is based on $T_{J(pk)} = 150^\circ\text{C}$; T_C is variable depending on conditions. Second breakdown pulse limits are valid for duty cycles to 10% provided $T_{J(pk)} < 150^\circ\text{C}$. $T_{J(pk)}$ may be calculated from the data in Figure 5. At high case temperatures, thermal limitations will reduce the power that can be handled to values less than the limitations imposed by second breakdown

TIP120, TIP121, TIP122 (NPN); TIP125, TIP126, TIP127 (PNP)

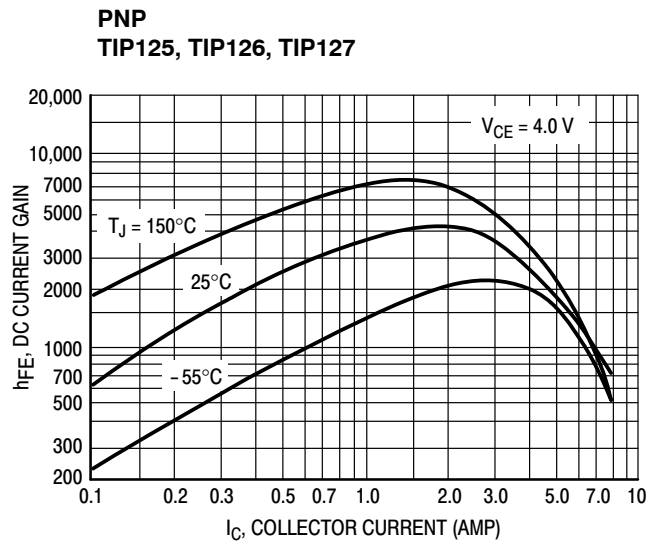
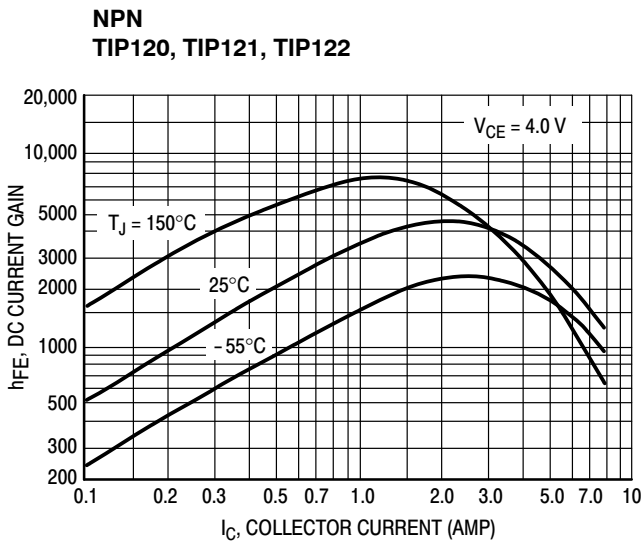

Figure 9. DC Current Gain

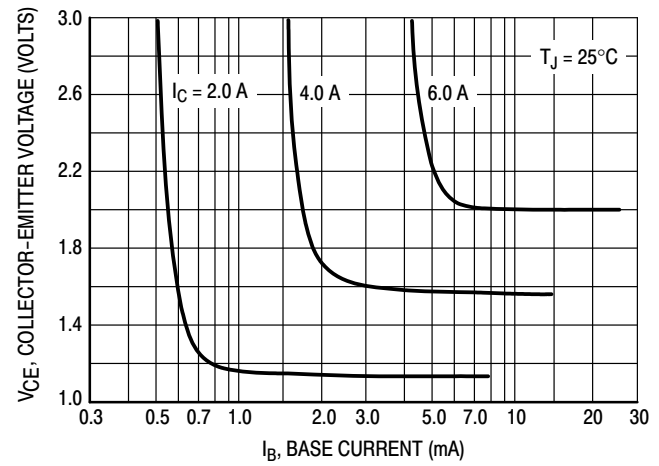
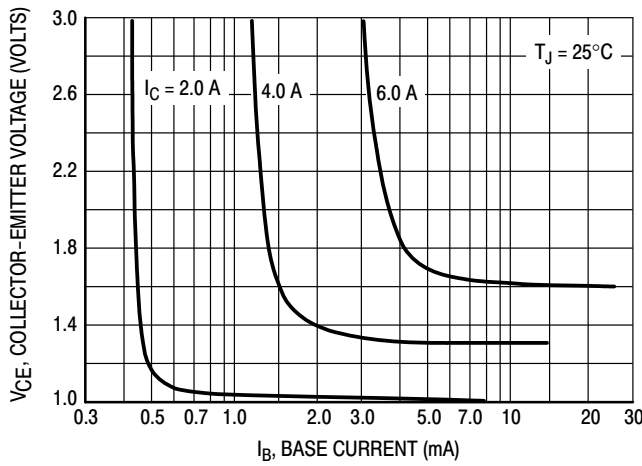

Figure 10. Collector Saturation Region

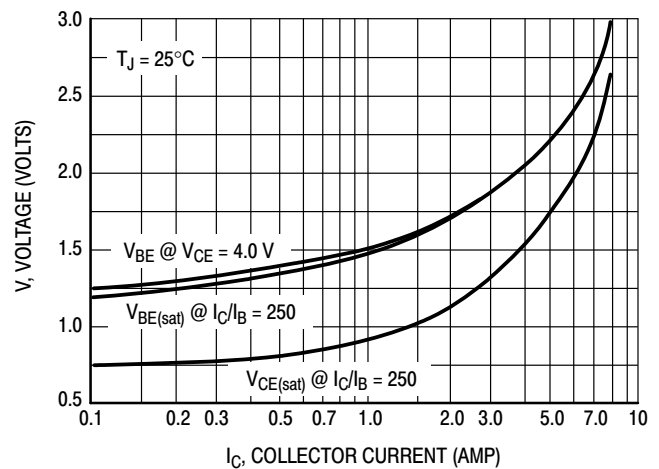
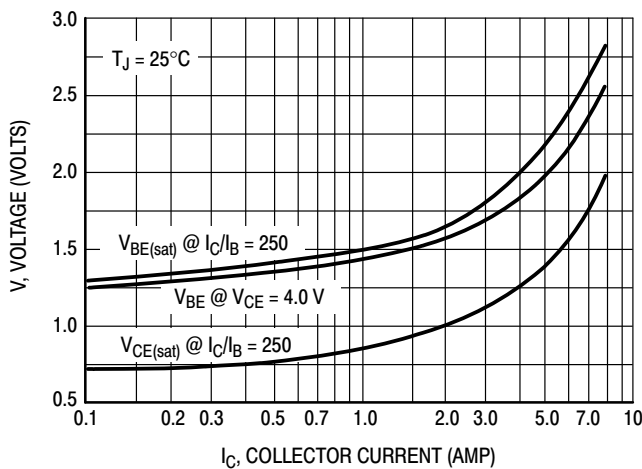

Figure 11. "On" Voltages

onsemi, **Onsemi**, and other names, marks, and brands are registered and/or common law trademarks of Semiconductor Components Industries, LLC dba "**onsemi**" or its affiliates and/or subsidiaries in the United States and/or other countries. **onsemi** owns the rights to a number of patents, trademarks, copyrights, trade secrets, and other intellectual property. A listing of **onsemi**'s product/patent coverage may be accessed at www.onsemi.com/site/pdf/Patent-Marking.pdf. **onsemi** reserves the right to make changes at any time to any products or information herein, without notice. The information herein is provided "as-is" and **onsemi** makes no warranty, representation or guarantee regarding the accuracy of the information, product features, availability, functionality, or suitability of its products for any particular purpose, nor does **onsemi** assume any liability arising out of the application or use of any product or circuit, and specifically disclaims any and all liability, including without limitation special, consequential or incidental damages. Buyer is responsible for its products and applications using **onsemi** products, including compliance with all laws, regulations and safety requirements or standards, regardless of any support or applications information provided by **onsemi**. "Typical" parameters which may be provided in **onsemi** data sheets and/or specifications can and do vary in different applications and actual performance may vary over time. All operating parameters, including "Typicals" must be validated for each customer application by customer's technical experts. **onsemi** does not convey any license under any of its intellectual property rights nor the rights of others. **onsemi** products are not designed, intended, or authorized for use as a critical component in life support systems or any FDA Class 3 medical devices or medical devices with a same or similar classification in a foreign jurisdiction or any devices intended for implantation in the human body. Should Buyer purchase or use **onsemi** products for any such unintended or unauthorized application, Buyer shall indemnify and hold **onsemi** and its officers, employees, subsidiaries, affiliates, and distributors harmless against all claims, costs, damages, and expenses, and reasonable attorney fees arising out of, directly or indirectly, any claim of personal injury or death associated with such unintended or unauthorized use, even if such claim alleges that **onsemi** was negligent regarding the design or manufacture of the part. **onsemi** is an Equal Opportunity/Affirmative Action Employer. This literature is subject to all applicable copyright laws and is not for resale in any manner.

ADDITIONAL INFORMATION

TECHNICAL PUBLICATIONS:

Technical Library: www.onsemi.com/design/resources/technical-documentation
onsemi Website: www.onsemi.com

ONLINE SUPPORT: www.onsemi.com/support

For additional information, please contact your local Sales Representative at www.onsemi.com/support/sales



单击下面可查看定价，库存，交付和生命周期等信息

[>>ON Semiconductor\(安森美\)](#)