



ON Semiconductor®

NC7SZ86 TinyLogic® UHS Two-Input Exclusive-OR Gate

Features

- Ultra-High Speed: t_{PD} 2.9ns (Typical) into 50pF at 5V V_{CC}
- High Output Drive: $\pm 24mA$ at 3V V_{CC}
- Broad V_{CC} Operating Range: 1.65V to 5.5V
- Matches Performance of LCX Operated at 3.3V V_{CC}
- Power Down High-Impedance Inputs/Outputs
- Over-Voltage Tolerance inputs facilitate 5V to 3V Translation
- Proprietary Noise/EMI Reduction Circuitry
- Ultra-Small MicroPak™ Packages
- Space-Saving SOT23 and SC70 Packages

Description

The NC7SZ86 is a single two-input exclusive-OR gate from ON Semiconductor's Ultra-High Speed (UHS) series of TinyLogic®. The device is fabricated with advanced CMOS technology to achieve ultra-high speed with high output drive while maintaining low static power dissipation over a broad V_{CC} operating range. The device is specified to operate over the 1.65V to 5.5V V_{CC} operating range. The inputs and output are high impedance when V_{CC} is 0V. Inputs tolerate voltages up to 6V, independent of V_{CC} operating voltage.

Ordering Information

Part Number	Top Mark	 Eco Status	Package	Packing Method
NC7SZ86M5X	7Z86	RoHS	5-Lead SOT23, JEDEC MO-178 1.6mm	3000 Units on Tape & Reel
NC7SZ86P5X	Z86	RoHS	5-Lead SC70, EIAJ SC-88a, 1.25mm Wide	3000 Units on Tape & Reel
NC7SZ86L6X	B3	RoHS	6-Lead MicroPak™, 1.00mm Wide	5000 Units on Tape & Reel
NC7SZ86FHX	B3	Green	6-Lead, MicroPak2, 1x1mm Body, .35mm Pitch	5000 Units on Tape & Reel

NC7SZ86 — TinyLogic® UHS Two-Input Exclusive-OR Gate

Connection Diagrams

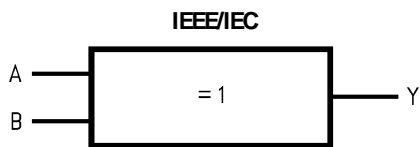

Figure 1. Logic Symbol

Pin Configurations

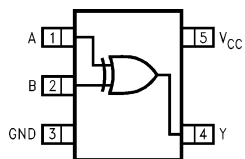

Figure 2. SC70 and SOT23 (Top View)

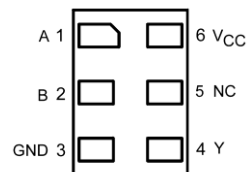

Figure 3. MicroPak™ (Top Through View)

Pin Definitions

Pin # SC70 / SOT23	Pin # MicroPak	Name	Description
1	1	A	Input
2	2	B	Input
3	3	GND	Ground
4	4	Y	Output
5	6	V _{CC}	Supply Voltage
	5	NC	No Connect

Function Table

$$Y = A + B$$

Inputs		Output
A	B	Y
L	L	L
L	H	H
H	L	H
H	H	L

H = HIGH Logic Level

L = LOW Logic Level

Absolute Maximum Ratings

Stresses exceeding the absolute maximum ratings may damage the device. The device may not function or be operable above the recommended operating conditions and stressing the parts to these levels is not recommended. In addition, extended exposure to stresses above the recommended operating conditions may affect device reliability. The absolute maximum ratings are stress ratings only.

Symbol	Parameter		Min.	Max.	Unit
V_{CC}	Supply Voltage		-0.5	6.0	V
V_{IN}	DC Input Voltage		-0.5	6.0	V
V_{OUT}	DC Output Voltage		-0.5	6.0	V
I_{IK}	DC Input Diode Current	$V_{IN} < -0.5V$		-50	mA
		$V_{IN} > 6.0V$		+20	
I_{OK}	DC Output Diode Current	$V_{OUT} < -0.5V$		-50	mA
		$V_{OUT} > 6V, V_{CC}=GND$		+20	
I_{OUT}	DC Output Current			±50	mA
I_{CC} or I_{GND}	DC V_{CC} or Ground Current			±50	mA
T_{STG}	Storage Temperature Range		-65	+150	°C
T_J	Junction Temperature Under Bias			+150	°C
T_L	Junction Lead Temperature (Soldering, 10 Seconds)			+260	°C
P_D	Power Dissipation at +85°C	SOT-23		200	mW
		SC70-5		150	
		MicroPak-6		130	
		MicroPak2-6		120	
ESD	Human Body Model, JEDEC:JESD22-A114			4000	V
	Charge Device Model: JEDEC:JESD22-C101			2000	

Recommended Operating Conditions

The Recommended Operating Conditions table defines the conditions for actual device operation. Recommended operating conditions are specified to ensure optimal performance to the datasheet specifications. ON Semiconductor does not recommend exceeding them or designing to Absolute Maximum Ratings.

Symbol	Parameter	Conditions	Min.	Max.	Unit
V_{CC}	Supply Voltage Operating		1.65	5.50	V
	Supply Voltage Data Retention		1.50	5.50	
V_{IN}	Input Voltage		0	5.5	V
V_{OUT}	Output Voltage		0	V_{CC}	V
T_A	Operating Temperature		-40	+85	°C
t_r, t_f	Input Rise and Fall Times	$V_{CC}=1.8V, 2.5V \pm 0.2V$	0	20	ns/V
		$V_{CC}=3.3V \pm 0.3V$	0	10	
		$V_{CC}=5.0V \pm 0.5V$	0	5	
θ_{JA}	Thermal Resistance	SOT-23		300	°C/W

		SC70-5		425	
		MicroPak-6		500	
		MicroPak2-6		560	

Note:

1. Unused inputs must be held HIGH or LOW. They may not float.

DC Electrical Characteristics

Symbol	Parameter	V _{CC}	Conditions	T _A =+25°C			T _A =-40 to +85°C		Units
				Min.	Typ.	Max.	Min.	Max.	
V _{IH}	HIGH Level Input Voltage	1.65 to 1.95		0.75V _{CC}			0.75V _{CC}		V
		2.30 to 5.50		0.70V _{CC}			0.70V _{CC}		
V _{IL}	LOW Level Input Voltage	1.65 to 1.95				0.25V _{CC}		0.25V _{CC}	V
		2.30 to 5.50				0.30V _{CC}		0.30V _{CC}	
V _{OH}	HIGH Level Output Voltage	1.65	V _{IN} =V _{IH} , V _{IL} I _{OH} =-100μA	1.55	1.65		1.55		V
		1.80		1.70	1.80		1.70		
		2.30		2.20	2.30		2.20		
		3.00		2.90	3.00		2.90		
		4.50		4.40	4.50		4.40		
		1.65	I _{OH} =-4mA	1.29	1.52		1.29		
		2.30	I _{OH} =-8mA	1.90	2.15		1.90		
		3.00	I _{OH} =-16mA	2.40	2.80		2.40		
		3.00	I _{OH} =-24mA	2.30	2.68		2.30		
		4.50	I _{OH} =-32mA	3.80	4.20		3.80		
V _{OL}	LOW Level Output Voltage	1.65	V _{IN} =V _{IH} , or V _{IL} I _{OL} =100μA		0.00	0.10		0.10	V
		1.80			0.00	0.10		0.10	
		2.30			0.00	0.10		0.10	
		3.00			0.00	0.10		0.10	
		4.50			0.00	0.10		0.10	
		1.65	I _{OL} =4mA		0.80	0.24		0.24	
		2.30	I _{OL} =8mA		0.10	0.30		0.30	
		3.00	I _{OL} =16mA		0.15	0.40		0.40	
		3.00	I _{OL} =24mA		0.22	0.55		0.55	
		4.50	I _{OL} =32mA		0.22	0.55		0.55	
I _{IN}	Input Leakage Current	0 to 5.5	V _{IN} =5.5V, GND			±1		±10	μA
I _{OFF}	Power Off Leakage Current	0	V _{IN} or V _{OUT} =5.5V			1		10	μA
I _{CC}	Quiescent Supply Current	1.65 to 5.50	V _{IN} =5.5V, GND			2		20	μA

AC Electrical Characteristics

Symbol	Parameter	V _{CC}	Conditions	T _A =+25°C			T _A =-40 to +85°C		Units	Figure
				Min.	Typ.	Max.	Min.	Max.		
t _{PLH} , t _{PHL}	Propagation Delay	1.65	C _L =15pF, R _L =1MΩ	2.0	6.9	13.8	2.0	14.5	ns	Figure 4 Figure 5
		1.80		2.0	5.7	11.5	2.0	12.0		
		2.50 ± 0.20		0.8	3.8	8.0	0.8	8.5		

		3.30 ± 0.30		0.5	3.0	5.7	0.5	6.0		
		5.00 ± 0.50		0.5	2.4	5.0	0.5	5.4		
		3.30 ± 0.30	C _L =50pF, R _L =500Ω	1.5	3.5	6.2	1.5	6.5		
		5.00 ± 0.50		0.8	2.9	5.4	1.0	5.8		
C _{IN}	Input Capacitance	0.00			4				pF	
C _{PD}	Power Dissipation Capacitance ⁽²⁾	3.30			25				pF	Figure 6
		5.00			31					

Note:

- C_{PD} is defined as the value of the internal equivalent capacitance which is derived from dynamic operating current consumption (I_{CCD}) at no output loading and operating at 50% duty cycle. C_{PD} is related to I_{CCD} dynamic operating current by the expression: I_{CCD}=(C_{PD})(V_{CC})(f_{IN})+(I_{CC}static).

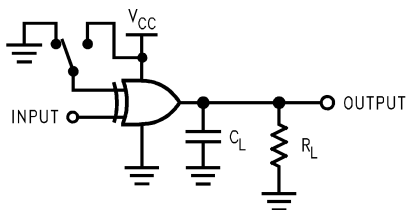

Figure 4. AC Test Circuit

Note:

- C_L includes load and stray capacitance. Input PRR=10MHz t_w=500ns.

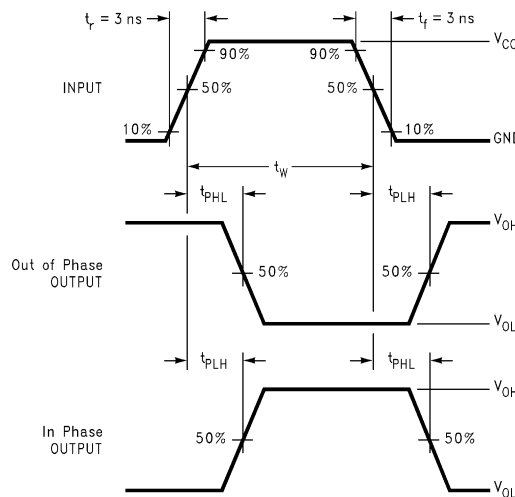

Figure 5. AC Waveforms

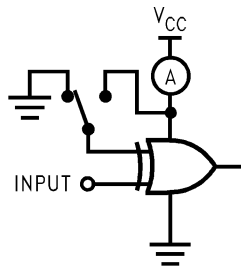

Figure 6. I_{CCD} Test Circuit

Note:

- Input=AC Waveform; t_r=t_f=1.8ns; PRR=10MHz; Duty Cycle=50%

Physical Dimensions

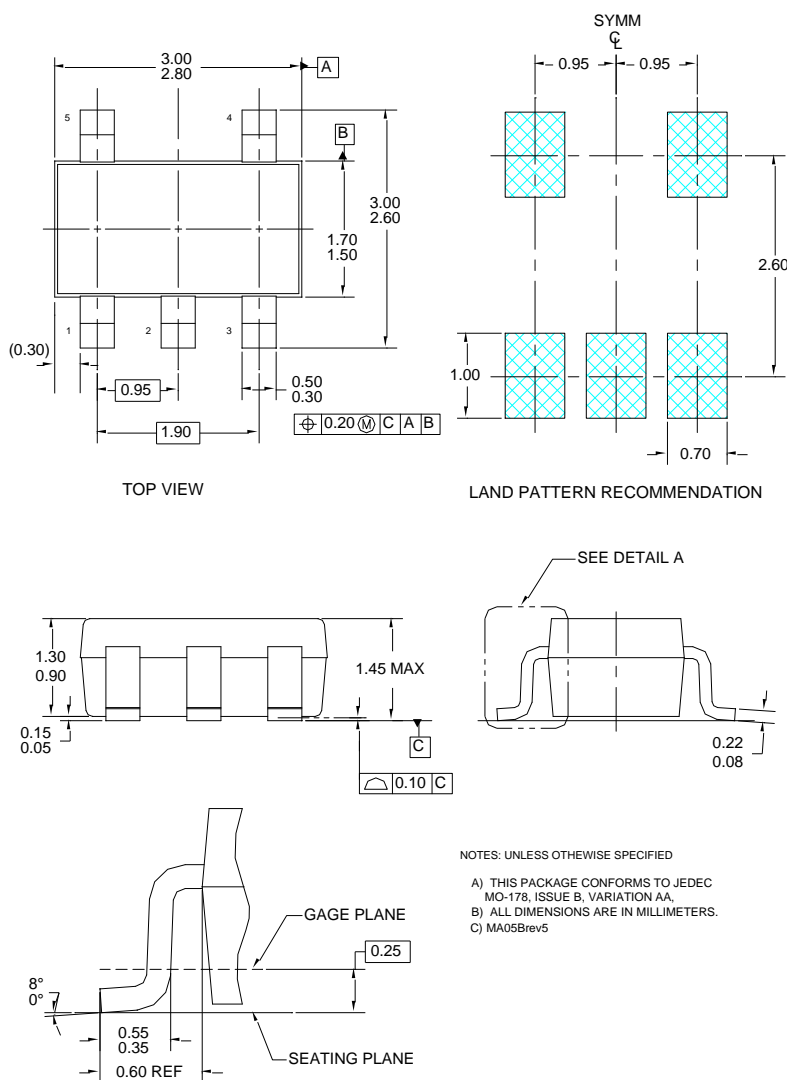

Figure 7. 5-Lead SOT23, JEDEC MO-178 1.6mm

Package drawings are provided as a service to customers considering ON Semiconductor components. Drawings may change in any manner without notice. Please note the revision and/or date on the drawing and contact a ON Semiconductor representative to verify or obtain the most recent revision. Package specifications do not expand the terms of ON Semiconductor's worldwide terms and conditions, specifically the warranty therein, which covers ON Semiconductor products.

Tape and Reel Specifications

Package Designator	Tape Section	Cavity Number	Cavity Status	Cover Type Status
M5X	Leader (Start End)	125 (Typical)	Empty	Sealed
	Carrier	3000	Filled	Sealed
	Trailer (Hub End)	75 (Typical)	Empty	Sealed

Physical Dimensions

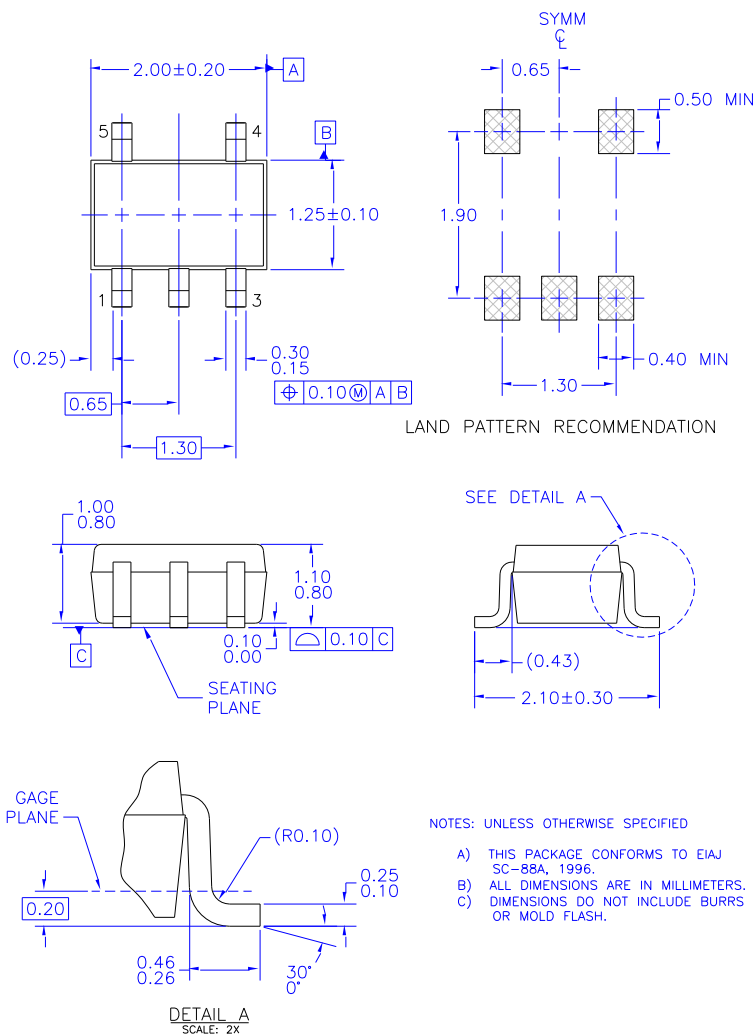

MAA05AREV5

Figure 8. 5-Lead, SC70, EIAJ SC-88a, 1.25mm Wide

Package drawings are provided as a service to customers considering ON Semiconductor components. Drawings may change in any manner without notice. Please note the revision and/or date on the drawing and contact a ON Semiconductor representative to verify or obtain the most recent revision. Package specifications do not expand the terms of ON Semiconductor's worldwide terms and conditions, specifically the warranty therein, which covers ON Semiconductor products.

Tape and Reel Specifications

Package Designator	Tape Section	Cavity Number	Cavity Status	Cover Type Status
P5X	Leader (Start End)	125 (Typical)	Empty	Sealed
	Carrier	3000	Filled	Sealed
	Trailer (Hub End)	75 (Typical)	Empty	Sealed

Physical Dimensions

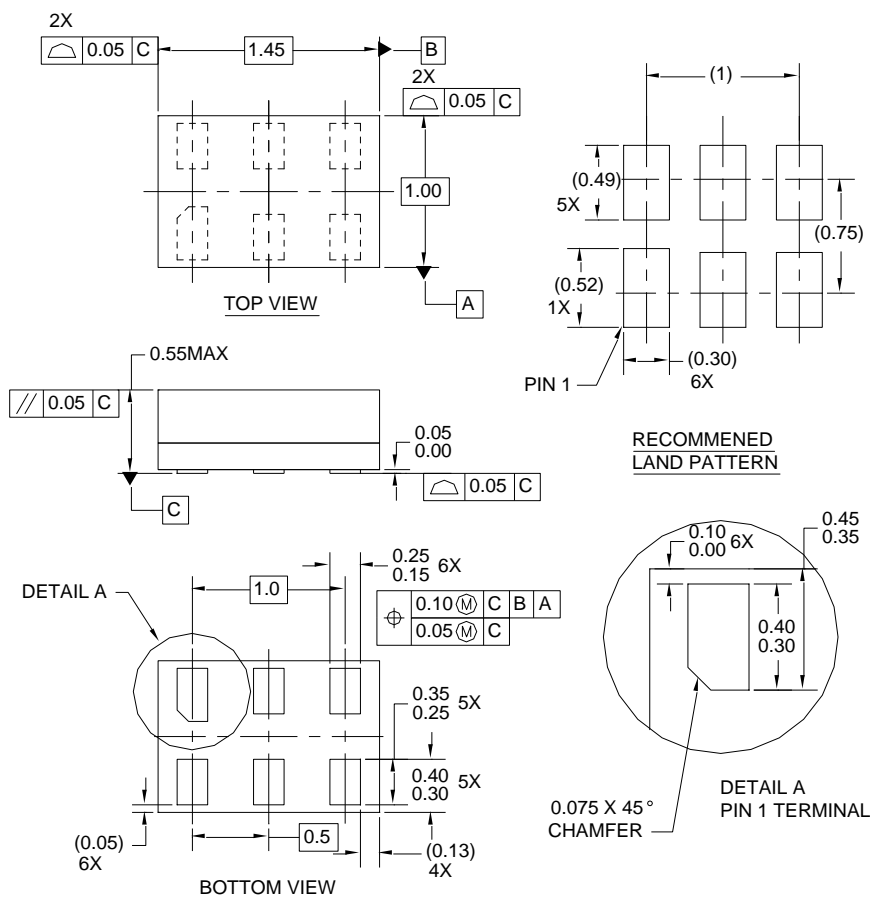

Notes:

1. CONFORMS TO JEDEC STANDARD M0-252 VARIATION UAAD
2. DIMENSIONS ARE IN MILLIMETERS
3. DRAWING CONFORMS TO ASME Y14.5M-1994

MAC06AREVC

Figure 9. 6-Lead, MicroPak™, 1.0mm Wide

Package drawings are provided as a service to customers considering ON Semiconductor components. Drawings may change in any manner without notice. Please note the revision and/or date on the drawing and contact a ON Semiconductor representative to verify or obtain the most recent revision. Package specifications do not expand the terms of ON Semiconductor's worldwide terms and conditions, specifically the warranty therein, which covers ON Semiconductor products.

Tape and Reel Specifications

Package Designator	Tape Section	Cavity Number	Cavity Status	Cover Type Status
L6X	Leader (Start End)	125 (Typical)	Empty	Sealed
	Carrier	5000	Filled	Sealed
	Trailer (Hub End)	75 (Typical)	Empty	Sealed

Physical Dimensions

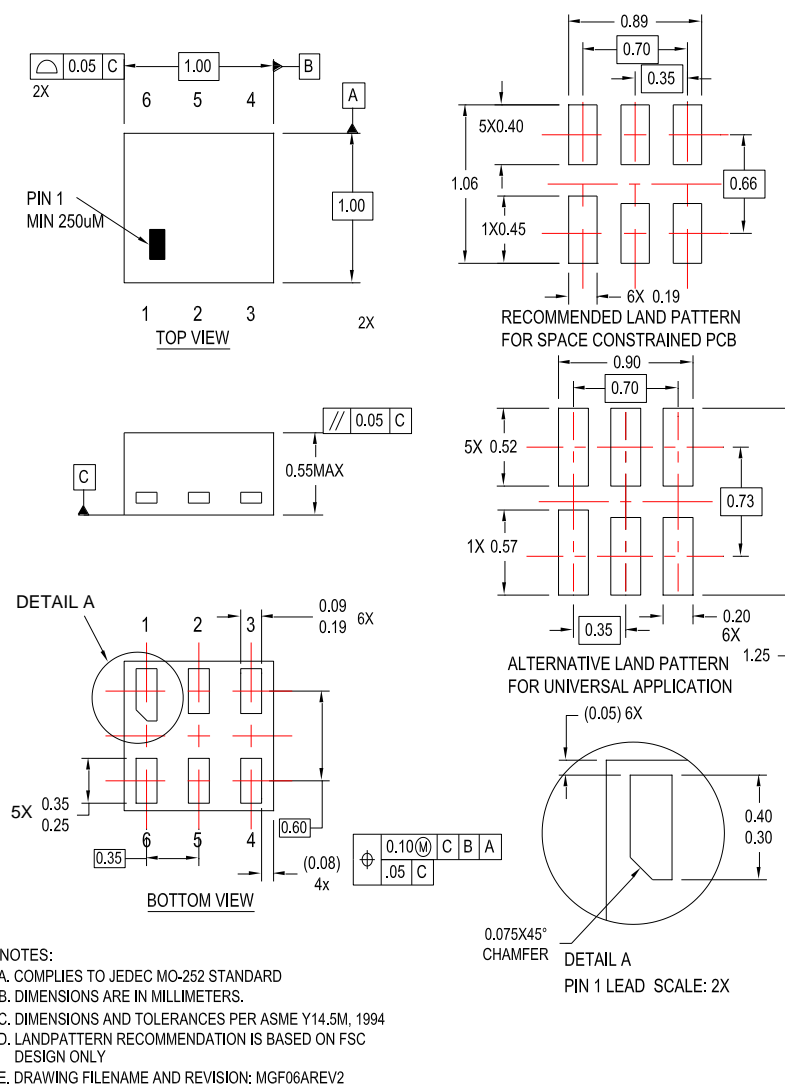

Figure 10. 6-Lead, MicroPak2, 1x1mm Body, .35mm Pitch

Package drawings are provided as a service to customers considering ON Semiconductor components. Drawings may change in any manner without notice. Please note the revision and/or date on the drawing and contact a ON Semiconductor representative to verify or obtain the most recent revision. Package specifications do not expand the terms of ON Semiconductor's worldwide terms and conditions, specifically the warranty therein, which covers ON Semiconductor products.

Tape and Reel Specifications

Package Designator	Tape Section	Cavity Number	Cavity Status	Cover Type Status
FHX	Leader (Start End)	125 (Typical)	Empty	Sealed
	Carrier	5000	Filled	Sealed
	Trailer (Hub End)	75 (Typical)	Empty	Sealed

ON Semiconductor and the ON Semiconductor logo are trademarks of Semiconductor Components Industries, LLC dba ON Semiconductor or its subsidiaries in the United States and/or other countries. ON Semiconductor owns the rights to a number of patents, trademarks, copyrights, trade secrets, and other intellectual property. A listing of ON Semiconductor's product/patent coverage may be accessed at www.onsemi.com/site/pdf/Patent-Marking.pdf. ON Semiconductor reserves the right to make changes without further notice to any products herein. ON Semiconductor makes no warranty, representation or guarantee regarding the suitability of its products for any particular purpose, nor does ON Semiconductor assume any liability arising out of the application or use of any product or circuit, and specifically disclaims any and all liability, including without limitation special, consequential or incidental damages. Buyer is responsible for its products and applications using ON Semiconductor products, including compliance with all laws, regulations and safety requirements or standards, regardless of any support or applications information provided by ON Semiconductor. "Typical" parameters which may be provided in ON Semiconductor data sheets and/or specifications can and do vary in different applications and actual performance may vary over time. All operating parameters, including "Typicals" must be validated for each customer application by customer's technical experts. ON Semiconductor does not convey any license under its patent rights nor the rights of others. ON Semiconductor products are not designed, intended, or authorized for use as a critical component in life support systems or any FDA Class 3 medical devices or medical devices with a same or similar classification in a foreign jurisdiction or any devices intended for implantation in the human body. Should Buyer purchase or use ON Semiconductor products for any such unintended or unauthorized application, Buyer shall indemnify and hold ON Semiconductor and its officers, employees, subsidiaries, affiliates, and distributors harmless against all claims, costs, damages, and expenses, and reasonable attorney fees arising out of, directly or indirectly, any claim of personal injury or death associated with such unintended or unauthorized use, even if such claim alleges that ON Semiconductor was negligent regarding the design or manufacture of the part. ON Semiconductor is an Equal Opportunity/Affirmative Action Employer. This literature is subject to all applicable copyright laws and is not for resale in any manner.

PUBLICATION ORDERING INFORMATION

LITERATURE FULFILLMENT:

Literature Distribution Center for ON Semiconductor
 19521 E. 32nd Pkwy, Aurora, Colorado 80011 USA
Phone: 303-675-2175 or 800-344-3860 Toll Free
 USA/Canada
Fax: 303-675-2176 or 800-344-3867 Toll Free USA/Canada
Email: orderlit@onsemi.com

N. American Technical Support: 800-282-9855 Toll Free
 USA/Canada.
Europe, Middle East and Africa Technical Support:
 Phone: 421 33 790 2910
Japan Customer Focus Center
 Phone: 81-3-5817-1050

ON Semiconductor Website: www.onsemi.com
Order Literature: <http://www.onsemi.com/orderlit>
 For additional information, please contact your local Sales Representative

单击下面可查看定价，库存，交付和生命周期等信息

[>>ON Semiconductor\(安森美\)](#)