

# NSS1C201L, NSV1C201L

## 100 V, 3.0 A, Low $V_{CE(sat)}$ NPN Transistor

ON Semiconductor's e<sup>2</sup>PowerEdge family of low  $V_{CE(sat)}$  transistors are miniature surface mount devices featuring ultra low saturation voltage ( $V_{CE(sat)}$ ) and high current gain capability. These are designed for use in low voltage, high speed switching applications where affordable efficient energy control is important.

Typical applications are DC-DC converters and power management in portable and battery powered products such as cellular and cordless phones, PDAs, computers, printers, digital cameras and MP3 players. Other applications are low voltage motor controls in mass storage products such as disc drives and tape drives. In the automotive industry they can be used in air bag deployment and in the instrument cluster. The high current gain allows e<sup>2</sup>PowerEdge devices to be driven directly from PMU's control outputs, and the Linear Gain (Beta) makes them ideal components in analog amplifiers.

### Features

- NSV Prefix for Automotive and Other Applications Requiring Unique Site and Control Change Requirements; AEC-Q101 Qualified and PPAP Capable
- These Devices are Pb-Free, Halogen Free/BFR Free and are RoHS Compliant

### MAXIMUM RATINGS ( $T_A = 25^\circ\text{C}$ )

Rating	Symbol	Max	Unit
Collector-Emitter Voltage	$V_{CEO}$	100	Vdc
Collector-Base Voltage	$V_{CBO}$	140	Vdc
Emitter-Base Voltage	$V_{EBO}$	7.0	Vdc
Collector Current - Continuous	$I_C$	2.0	A
Collector Current - Peak	$I_{CM}$	3.0	A

### THERMAL CHARACTERISTICS

Characteristic	Symbol	Max	Unit
Total Device Dissipation $T_A = 25^\circ\text{C}$ Derate above $25^\circ\text{C}$	$P_D$ (Note 1)	490 3.7	mW mW/°C
Thermal Resistance, Junction-to-Ambient	$R_{\theta JA}$ (Note 1)	255	°C/W
Total Device Dissipation $T_A = 25^\circ\text{C}$ Derate above $25^\circ\text{C}$	$P_D$ (Note 2)	710 4.3	mW mW/°C
Thermal Resistance, Junction-to-Ambient	$R_{\theta JA}$ (Note 2)	176	°C/W
Junction and Storage Temperature Range	$T_J, T_{stg}$	-55 to +150	°C

Stresses exceeding those listed in the Maximum Ratings table may damage the device. If any of these limits are exceeded, device functionality should not be assumed, damage may occur and reliability may be affected.

1. FR-4 @ 100 mm<sup>2</sup>, 1 oz. copper traces.
2. FR-4 @ 500 mm<sup>2</sup>, 1 oz. copper traces.



ON Semiconductor®

[www.onsemi.com](http://www.onsemi.com)

## 100 VOLTS, 3.0 AMPS NPN LOW $V_{CE(sat)}$ TRANSISTOR

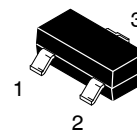
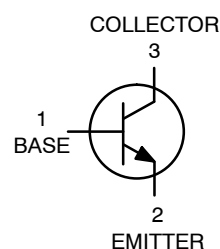

SOT-23 (TO-236)  
CASE 318  
STYLE 6

### MARKING DIAGRAM

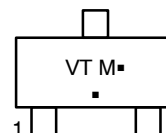

VT = Specific Device Code  
M = Date Code\*  
▪ = Pb-Free Package

(Note: Microdot may be in either location)

\*Date Code orientation and/or overbar may vary depending upon manufacturing location.

### ORDERING INFORMATION

Device	Package	Shipping†
NSS1C201LT1G, NSV1C201LT1G	SOT-23 (Pb-Free)	3000 / Tape & Reel

†For information on tape and reel specifications, including part orientation and tape sizes, please refer to our Tape and Reel Packaging Specification Brochure, BRD8011/D.

# NSS1C201L, NSV1C201L

## ELECTRICAL CHARACTERISTICS (T<sub>A</sub> = 25°C unless otherwise noted)

Characteristic	Symbol	Min	Typ	Max	Unit
<b>OFF CHARACTERISTICS</b>					
Collector – Emitter Breakdown Voltage (I <sub>C</sub> = 10 mAdc, I <sub>B</sub> = 0)	V <sub>(BR)CEO</sub>	100			Vdc
Collector – Base Breakdown Voltage (I <sub>C</sub> = 0.1 mAdc, I <sub>E</sub> = 0)	V <sub>(BR)CBO</sub>	140			Vdc
Emitter – Base Breakdown Voltage (I <sub>E</sub> = 0.1 mAdc, I <sub>C</sub> = 0)	V <sub>(BR)EBO</sub>	7.0			Vdc
Collector Cutoff Current (V <sub>CB</sub> = 140 Vdc, I <sub>E</sub> = 0)	I <sub>CBO</sub>			100	nAdc
Emitter Cutoff Current (V <sub>EB</sub> = 6.0 Vdc)	I <sub>EBO</sub>			50	nAdc

## ON CHARACTERISTICS

DC Current Gain (Note 3) (I <sub>C</sub> = 10 mA, V <sub>CE</sub> = 2.0 V) (I <sub>C</sub> = 500 mA, V <sub>CE</sub> = 2.0 V) (I <sub>C</sub> = 1.0 A, V <sub>CE</sub> = 2.0 V) (I <sub>C</sub> = 2.0 A, V <sub>CE</sub> = 2.0 V)	h <sub>FE</sub>	150 120 80 40	240	360	
Collector – Emitter Saturation Voltage (Note 3) (I <sub>C</sub> = 0.1 A, I <sub>B</sub> = 0.01 A) (I <sub>C</sub> = 0.5 A, I <sub>B</sub> = 0.05 A) (I <sub>C</sub> = 1.0 A, I <sub>B</sub> = 0.100 A) (I <sub>C</sub> = 2.0 A, I <sub>B</sub> = 0.200 A)	V <sub>CE(sat)</sub>			0.030 0.060 0.090 0.150	V
Base – Emitter Saturation Voltage (Note 3) (I <sub>C</sub> = 1.0 A, I <sub>B</sub> = 0.100 A)	V <sub>BE(sat)</sub>			0.950	V
Base – Emitter Turn-on Voltage (Note 3) (I <sub>C</sub> = 1.0 A, V <sub>CE</sub> = 2.0 V)	V <sub>BE(on)</sub>			0.850	V
Cutoff Frequency (I <sub>C</sub> = 100 mA, V <sub>CE</sub> = 5.0 V, f = 100 MHz)	f <sub>T</sub>		110		MHz
Input Capacitance (V <sub>EB</sub> = 2.0 V, f = 1.0 MHz)	C <sub>ibo</sub>		230		pF
Output Capacitance (V <sub>CB</sub> = 10 V, f = 1.0 MHz)	C <sub>obo</sub>		14		pF

Product parametric performance is indicated in the Electrical Characteristics for the listed test conditions, unless otherwise noted. Product performance may not be indicated by the Electrical Characteristics if operated under different conditions.

3. Pulsed Condition: Pulse Width = 300 msec, Duty Cycle ≤ 2%.

## TYPICAL CHARACTERISTICS

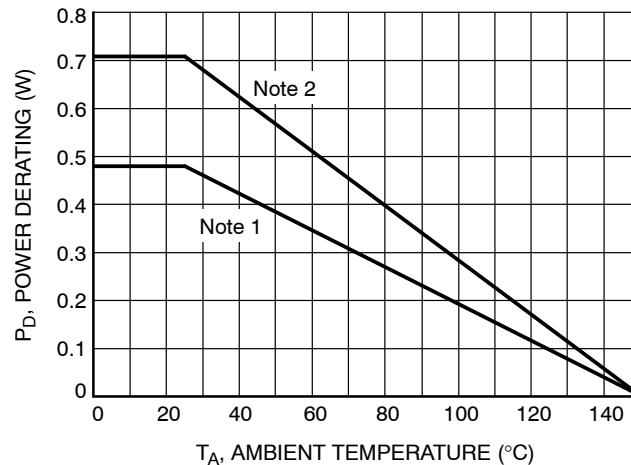

**Figure 1. Power Derating**

# NSS1C201L, NSV1C201L

## TYPICAL CHARACTERISTICS

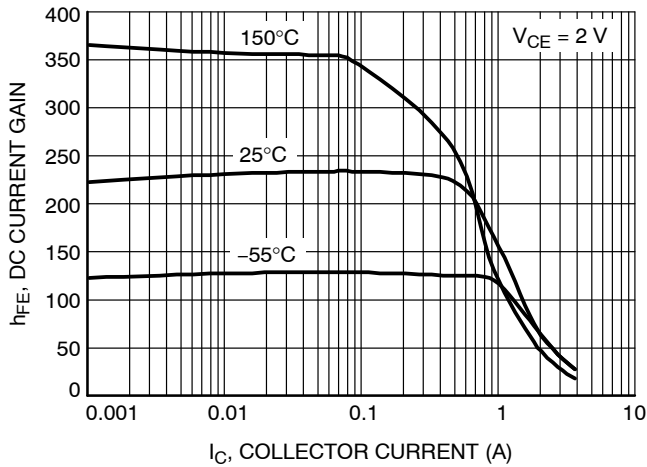

Figure 2. DC Current Gain

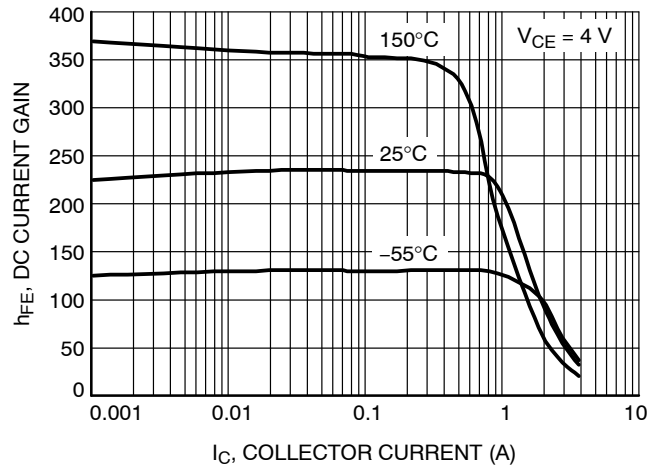

Figure 3. DC Current Gain

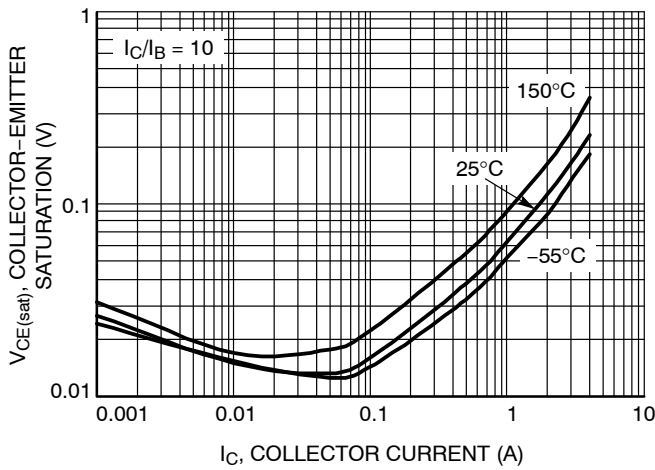

Figure 4. Collector-Emitter Saturation Voltage

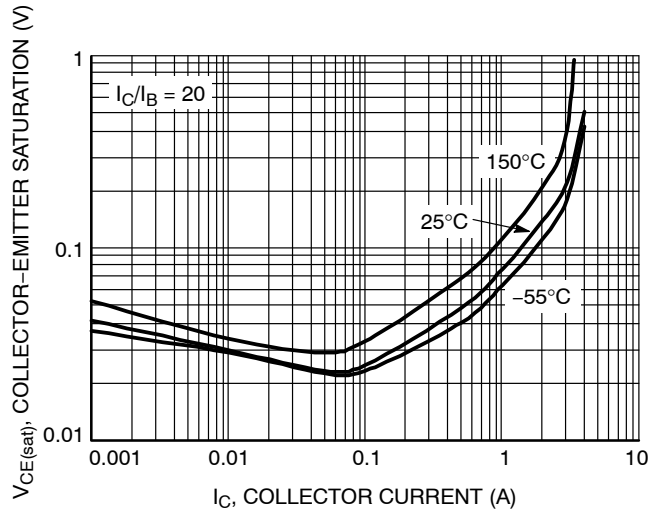

Figure 5. Collector-Emitter Saturation Voltage

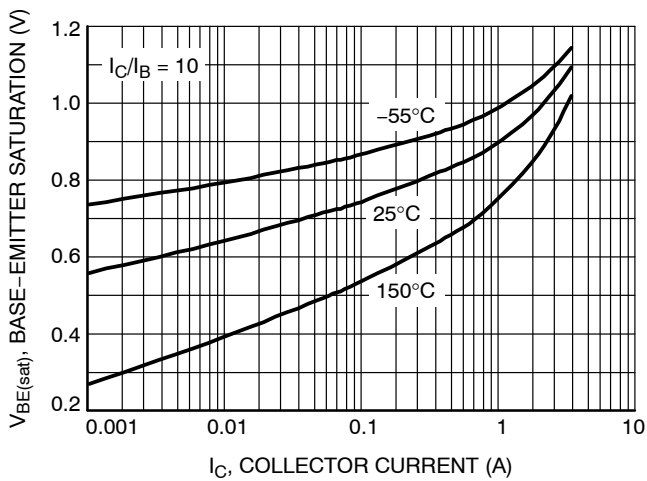

Figure 6. Base-Emitter Saturation Voltage

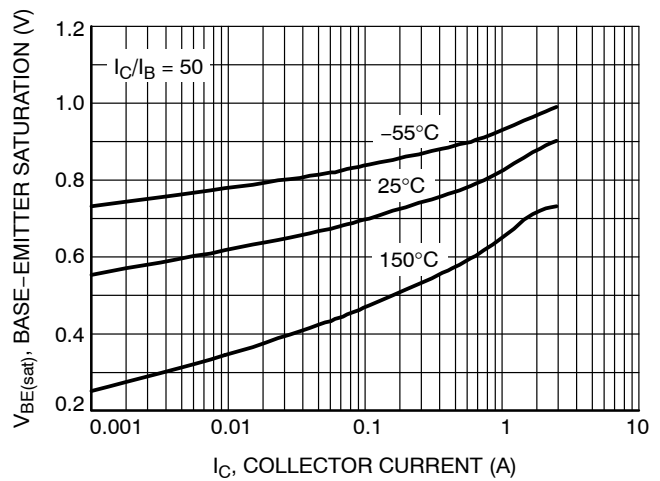

Figure 7. Base-Emitter Saturation Voltage

# NSS1C201L, NSV1C201L

## TYPICAL CHARACTERISTICS

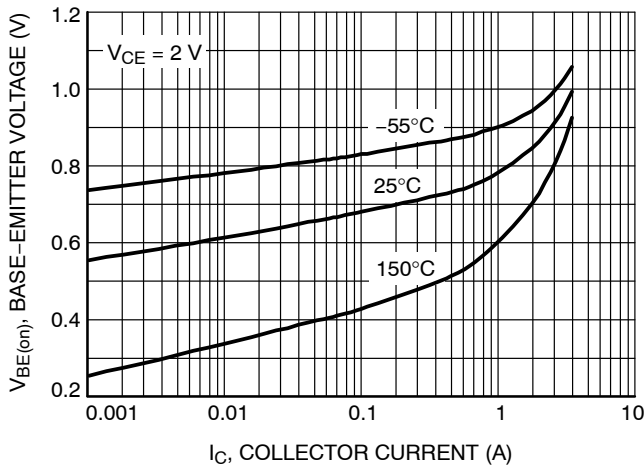

Figure 8. Base-Emitter Voltage

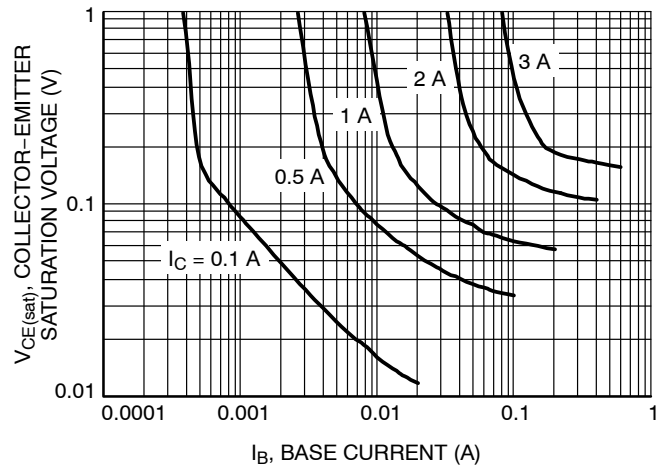

Figure 9. Collector Saturation Region

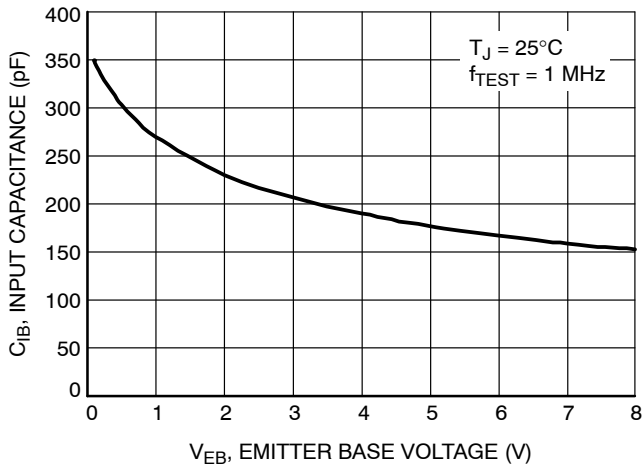

Figure 10. Input Capacitance

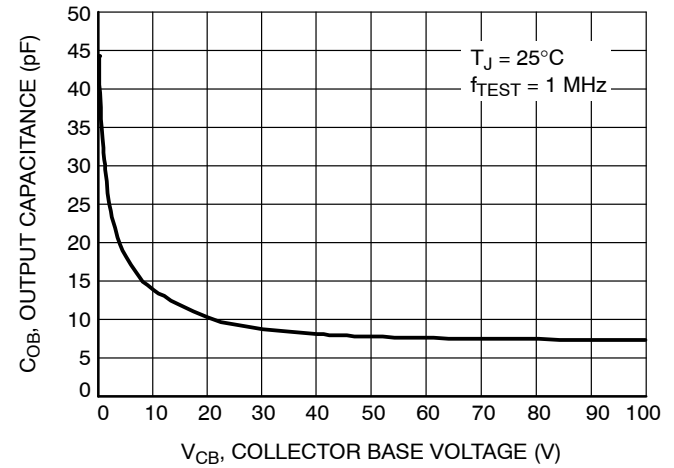

Figure 11. Output Capacitance

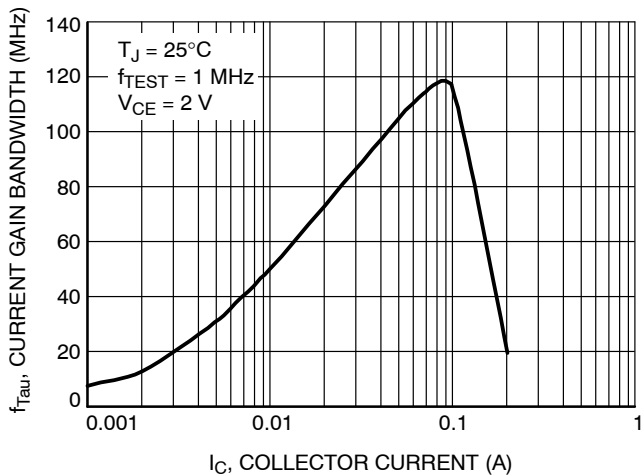

Figure 12. Current-Gain Bandwidth Product

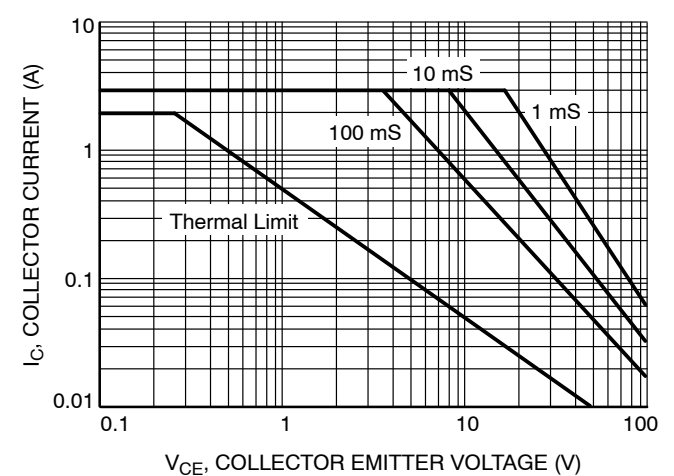

Figure 13. Safe Operating Area

# NSS1C201L, NSV1C201L

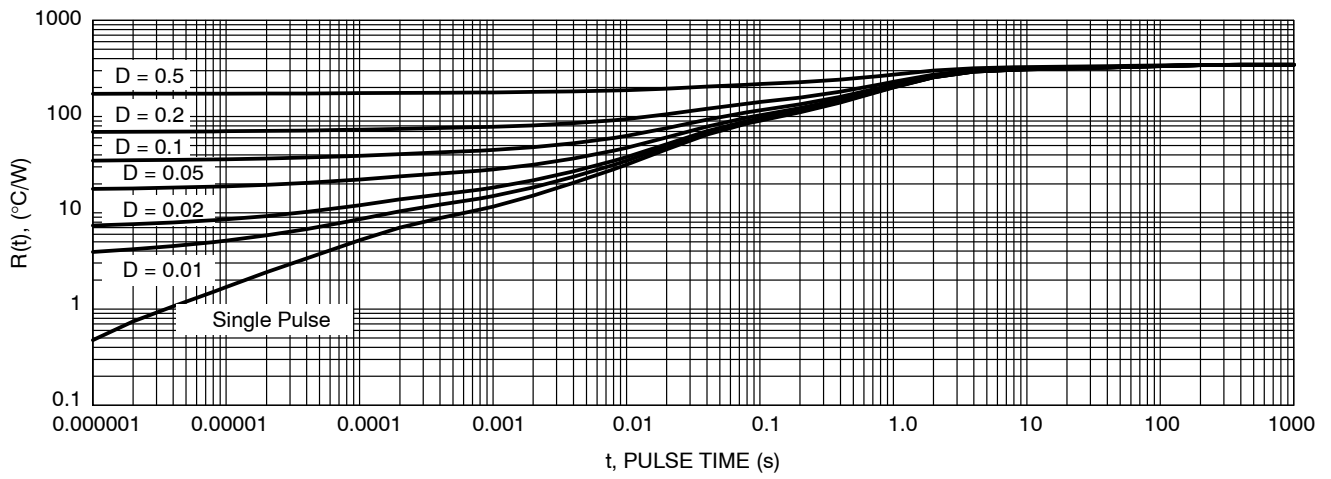

Figure 14. Transient Thermal Resistance

# MECHANICAL CASE OUTLINE PACKAGE DIMENSIONS



**SOT-23 (TO-236)**  
CASE 318  
ISSUE AT

DATE 01 MAR 2023

SCALE 4:1

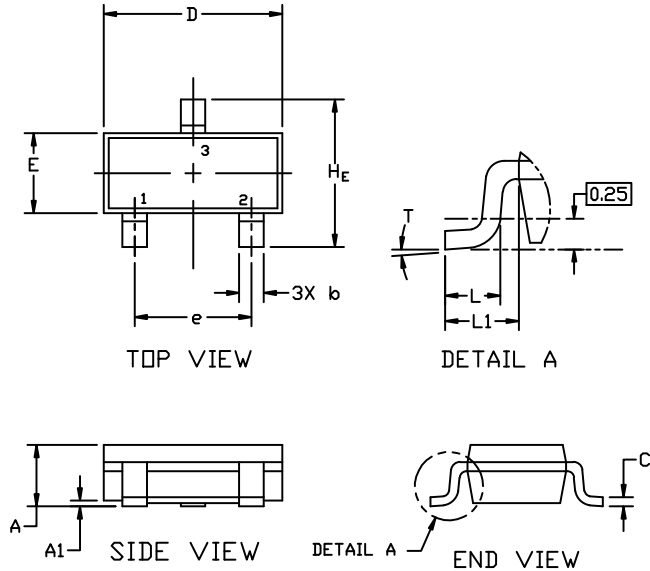

**NOTES:**

1. DIMENSIONING AND TOLERANCING PER ASME Y14.5M,1994.
2. CONTROLLING DIMENSION: MILLIMETERS
3. MAXIMUM LEAD THICKNESS INCLUDES LEAD FINISH. MINIMUM LEAD THICKNESS IS THE MINIMUM THICKNESS OF THE BASE MATERIAL.
4. DIMENSIONS D AND E DO NOT INCLUDE MOLD FLASH, PROTRUSIONS, OR GATE BURRS.

DIM	MILLIMETERS			INCHES		
	MIN.	NOM.	MAX.	MIN.	NOM.	MAX.
A	0.89	1.00	1.11	0.035	0.039	0.044
A1	0.01	0.06	0.10	0.000	0.002	0.004
b	0.37	0.44	0.50	0.015	0.017	0.020
c	0.08	0.14	0.20	0.003	0.006	0.008
D	2.80	2.90	3.04	0.110	0.114	0.120
E	1.20	1.30	1.40	0.047	0.051	0.055
e	1.78	1.90	2.04	0.070	0.075	0.080
L	0.30	0.43	0.55	0.012	0.017	0.022
L1	0.35	0.54	0.69	0.014	0.021	0.027
H <sub>E</sub>	2.10	2.40	2.64	0.083	0.094	0.104
T	0°	---	10°	0°	---	10°

**GENERIC MARKING DIAGRAM\***



- XXX = Specific Device Code
- M = Date Code
- = Pb-Free Package

\*This information is generic. Please refer to device data sheet for actual part marking. Pb-Free indicator, "G" or microdot "▪", may or may not be present. Some products may not follow the Generic Marking.

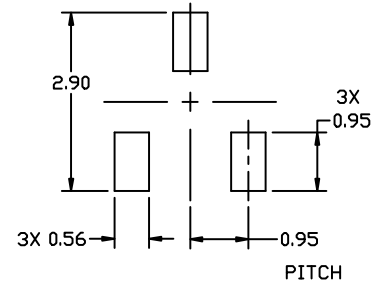

**RECOMMENDED MOUNTING FOOTPRINT**

\* For additional information on our Pb-Free strategy and soldering details, please download the ON Semiconductor Soldering and Mounting Techniques Reference Manual, SOLDERRM/D.

**STYLES ON PAGE 2**

<b>DOCUMENT NUMBER:</b>	<b>98ASB42226B</b>	Electronic versions are uncontrolled except when accessed directly from the Document Repository. Printed versions are uncontrolled except when stamped "CONTROLLED COPY" in red.
<b>DESCRIPTION:</b>	<b>SOT-23 (TO-236)</b>	<b>PAGE 1 OF 2</b>

onsemi and ONSEMI are trademarks of Semiconductor Components Industries, LLC dba onsemi or its subsidiaries in the United States and/or other countries. onsemi reserves the right to make changes without further notice to any products herein. onsemi makes no warranty, representation or guarantee regarding the suitability of its products for any particular purpose, nor does onsemi assume any liability arising out of the application or use of any product or circuit, and specifically disclaims any and all liability, including without limitation special, consequential or incidental damages. onsemi does not convey any license under its patent rights nor the rights of others.

**MECHANICAL CASE OUTLINE**  
**PACKAGE DIMENSIONS**



**SOT-23 (TO-236)**  
**CASE 318**  
**ISSUE AT**

DATE 01 MAR 2023

- STYLE 1 THRU 5:  
CANCELLED
- STYLE 6:  
PIN 1. BASE  
2. EMITTER  
3. COLLECTOR
- STYLE 7:  
PIN 1. EMITTER  
2. BASE  
3. COLLECTOR
- STYLE 8:  
PIN 1. ANODE  
2. NO CONNECTION  
3. CATHODE
- STYLE 9:  
PIN 1. ANODE  
2. ANODE  
3. CATHODE
- STYLE 10:  
PIN 1. DRAIN  
2. SOURCE  
3. GATE
- STYLE 11:  
PIN 1. ANODE  
2. CATHODE  
3. CATHODE-ANODE
- STYLE 12:  
PIN 1. CATHODE  
2. CATHODE  
3. ANODE
- STYLE 13:  
PIN 1. SOURCE  
2. DRAIN  
3. GATE
- STYLE 14:  
PIN 1. CATHODE  
2. GATE  
3. ANODE
- STYLE 15:  
PIN 1. GATE  
2. CATHODE  
3. ANODE
- STYLE 16:  
PIN 1. ANODE  
2. CATHODE  
3. CATHODE
- STYLE 17:  
PIN 1. NO CONNECTION  
2. ANODE  
3. CATHODE
- STYLE 18:  
PIN 1. NO CONNECTION  
2. CATHODE  
3. ANODE
- STYLE 19:  
PIN 1. CATHODE  
2. ANODE  
3. CATHODE-ANODE
- STYLE 20:  
PIN 1. CATHODE  
2. ANODE  
3. GATE
- STYLE 21:  
PIN 1. GATE  
2. SOURCE  
3. DRAIN
- STYLE 22:  
PIN 1. RETURN  
2. OUTPUT  
3. INPUT
- STYLE 23:  
PIN 1. ANODE  
2. ANODE  
3. CATHODE
- STYLE 24:  
PIN 1. GATE  
2. DRAIN  
3. SOURCE
- STYLE 25:  
PIN 1. ANODE  
2. CATHODE  
3. GATE
- STYLE 26:  
PIN 1. CATHODE  
2. ANODE  
3. NO CONNECTION
- STYLE 27:  
PIN 1. CATHODE  
2. CATHODE  
3. CATHODE
- STYLE 28:  
PIN 1. ANODE  
2. ANODE  
3. ANODE

<b>DOCUMENT NUMBER:</b>	<b>98ASB42226B</b>	Electronic versions are uncontrolled except when accessed directly from the Document Repository. Printed versions are uncontrolled except when stamped "CONTROLLED COPY" in red.
<b>DESCRIPTION:</b>	<b>SOT-23 (TO-236)</b>	<b>PAGE 2 OF 2</b>

**onsemi** and **ONSEMI** are trademarks of Semiconductor Components Industries, LLC dba **onsemi** or its subsidiaries in the United States and/or other countries. **onsemi** reserves the right to make changes without further notice to any products herein. **onsemi** makes no warranty, representation or guarantee regarding the suitability of its products for any particular purpose, nor does **onsemi** assume any liability arising out of the application or use of any product or circuit, and specifically disclaims any and all liability, including without limitation special, consequential or incidental damages. **onsemi** does not convey any license under its patent rights nor the rights of others.

**onsemi**, **Onsemi**, and other names, marks, and brands are registered and/or common law trademarks of Semiconductor Components Industries, LLC dba "**onsemi**" or its affiliates and/or subsidiaries in the United States and/or other countries. **onsemi** owns the rights to a number of patents, trademarks, copyrights, trade secrets, and other intellectual property. A listing of **onsemi**'s product/patent coverage may be accessed at [www.onsemi.com/site/pdf/Patent-Marking.pdf](http://www.onsemi.com/site/pdf/Patent-Marking.pdf). **onsemi** reserves the right to make changes at any time to any products or information herein, without notice. The information herein is provided "as-is" and **onsemi** makes no warranty, representation or guarantee regarding the accuracy of the information, product features, availability, functionality, or suitability of its products for any particular purpose, nor does **onsemi** assume any liability arising out of the application or use of any product or circuit, and specifically disclaims any and all liability, including without limitation special, consequential or incidental damages. Buyer is responsible for its products and applications using **onsemi** products, including compliance with all laws, regulations and safety requirements or standards, regardless of any support or applications information provided by **onsemi**. "Typical" parameters which may be provided in **onsemi** data sheets and/or specifications can and do vary in different applications and actual performance may vary over time. All operating parameters, including "Typicals" must be validated for each customer application by customer's technical experts. **onsemi** does not convey any license under any of its intellectual property rights nor the rights of others. **onsemi** products are not designed, intended, or authorized for use as a critical component in life support systems or any FDA Class 3 medical devices or medical devices with a same or similar classification in a foreign jurisdiction or any devices intended for implantation in the human body. Should Buyer purchase or use **onsemi** products for any such unintended or unauthorized application, Buyer shall indemnify and hold **onsemi** and its officers, employees, subsidiaries, affiliates, and distributors harmless against all claims, costs, damages, and expenses, and reasonable attorney fees arising out of, directly or indirectly, any claim of personal injury or death associated with such unintended or unauthorized use, even if such claim alleges that **onsemi** was negligent regarding the design or manufacture of the part. **onsemi** is an Equal Opportunity/Affirmative Action Employer. This literature is subject to all applicable copyright laws and is not for resale in any manner.

## ADDITIONAL INFORMATION

### TECHNICAL PUBLICATIONS:

Technical Library: [www.onsemi.com/design/resources/technical-documentation](http://www.onsemi.com/design/resources/technical-documentation)  
onsemi Website: [www.onsemi.com](http://www.onsemi.com)

### ONLINE SUPPORT: [www.onsemi.com/support](http://www.onsemi.com/support)

For additional information, please contact your local Sales Representative at [www.onsemi.com/support/sales](http://www.onsemi.com/support/sales)





单击下面可查看定价，库存，交付和生命周期等信息

[>>ON Semiconductor\(安森美\)](#)