

NTR4003N, NVR4003N

Small Signal MOSFET 30 V, 0.56 A, Single N-Channel, SOT-23

Features

- Low Gate Voltage Threshold ($V_{GS(TH)}$) to Facilitate Drive Circuit Design
- Low Gate Charge for Fast Switching
- ESD Protected Gate
- SOT-23 Package Provides Excellent Thermal Performance
- Minimum Breakdown Voltage Rating of 30 V
- NVR Prefix for Automotive and Other Applications Requiring Unique Site and Control Change Requirements; AEC-Q101 Qualified and PPAP Capable
- These Devices are Pb-Free and are RoHS Compliant

Applications

- Notebooks:
 - ◆ Level Shifters
 - ◆ Logic Switches
 - ◆ Low Side Load Switches
- Portable Applications

MAXIMUM RATINGS ($T_J = 25^\circ\text{C}$ unless otherwise noted)

Parameter		Symbol	Value	Unit	
Drain-to-Source Voltage		V_{DSS}	30	V	
Gate-to-Source Voltage		V_{GS}	± 20	V	
Continuous Drain Current (Note 1)	Steady State	I_D	$T_A = 25^\circ\text{C}$	0.5	A
			$T_A = 85^\circ\text{C}$	0.37	
Power Dissipation (Note 1)	Steady State	P_D	0.69	W	
Continuous Drain Current (Note 1)	$t < 10$ s	I_D	$T_A = 25^\circ\text{C}$	0.56	A
			$T_A = 85^\circ\text{C}$	0.40	
Power Dissipation (Note 1)	$t < 5$ s	P_D	0.83	W	
Pulsed Drain Current	$t_p = 10$ μs	I_{DM}	1.7	A	
Operating Junction and Storage Temperature		T_J, T_{stg}	-55 to 150	$^\circ\text{C}$	
Source Current (Body Diode)		I_S	1.0	A	
Lead Temperature for Soldering Purposes (1/8" from case for 10 s)		T_L	260	$^\circ\text{C}$	

Stresses exceeding those listed in the Maximum Ratings table may damage the device. If any of these limits are exceeded, device functionality should not be assumed, damage may occur and reliability may be affected.

THERMAL RESISTANCE RATINGS

Parameter	Symbol	Max	Unit
Junction-to-Ambient – Steady State (Note 1)	$R_{\theta JA}$	180	$^\circ\text{C/W}$
Junction-to-Ambient – $t < 10$ s (Note 1)	$R_{\theta JA}$	150	
Junction-to-Ambient – Steady State (Note 2)	$R_{\theta JA}$	300	

1. Surface-mounted on FR4 board using 1 in sq pad size (Cu area = 1.127 in sq [1 oz] including traces).
2. Surface-mounted on FR4 board using the minimum recommended pad size.



ON Semiconductor®

www.onsemi.com

$V_{(BR)DSS}$	$R_{DS(on)}$ TYP	I_D MAX
30 V	1.0 Ω @ 4.0 V	0.56 A
	1.5 Ω @ 2.5 V	

N-Channel

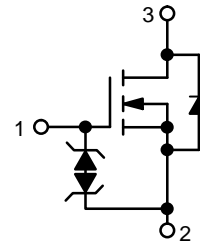

MARKING DIAGRAM/ PIN ASSIGNMENT

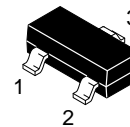

SOT-23
CASE 318
STYLE 21

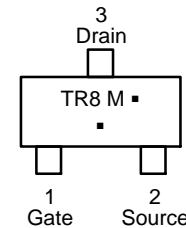

TR8 = Specific Device Code
M = Date Code
▪ = Pb-Free Package

(Note: Microdot may be in either location)

*Date Code orientation and overbar may vary depending upon manufacturing location.

ORDERING INFORMATION

Device	Package	Shipping†
NTR4003NT1G	SOT-23 (Pb-Free)	3000 / Tape & Reel
NTR4003NT3G	SOT-23 (Pb-Free)	10,000 / Tape & Reel
NVR4003NT3G	SOT-23 (Pb-Free)	10,000 / Tape & Reel

†For information on tape and reel specifications, including part orientation and tape sizes, please refer to our Tape and Reel Packaging Specification Brochure, BRD8011/D.

NTR4003N, NVR4003N

ELECTRICAL CHARACTERISTICS ($T_J = 25^\circ\text{C}$ unless otherwise specified)

Parameter	Symbol	Test Condition	Min	Typ	Max	Units
-----------	--------	----------------	-----	-----	-----	-------

OFF CHARACTERISTICS

Drain-to-Source Breakdown Voltage	$V_{(BR)DSS}$	$V_{GS} = 0\text{ V}, I_D = 100\ \mu\text{A}$	30			V
Drain-to-Source Breakdown Voltage Temperature Coefficient	$V_{(BR)DSS}/T_J$			40		mV/°C
Zero Gate Voltage Drain Current	I_{DSS}	$V_{GS} = 0\text{ V}, V_{DS} = 30\text{ V}$			1.0	μA
Gate-to-Source Leakage Current	I_{GSS}	$V_{DS} = 0\text{ V}, V_{GS} = \pm 10\text{ V}$			± 1.0	μA

ON CHARACTERISTICS (Note 3)

Gate Threshold Voltage	$V_{GS(TH)}$	$V_{GS} = V_{DS}, I_D = 250\ \mu\text{A}$	0.8		1.4	V
Negative Threshold Temperature Coefficient	$V_{GS(TH)}/T_J$			3.4		mV/°C
Drain-to-Source On Resistance	$R_{DS(on)}$	$V_{GS} = 4.0\text{ V}, I_D = 10\text{ mA}$		1.0	1.5	Ω
		$V_{GS} = 2.5\text{ V}, I_D = 10\text{ mA}$		1.5	2.0	
Forward Transconductance	g_{FS}	$V_{DS} = 3.0\text{ V}, I_D = 10\text{ mA}$		0.33		S

CHARGES AND CAPACITANCES

Input Capacitance	C_{iss}	$V_{GS} = 0\text{ V}, f = 1.0\text{ MHz}, V_{DS} = 5.0\text{ V}$		21	42	pF
Output Capacitance	C_{oss}			19.7	40	
Reverse Transfer Capacitance	C_{rss}			8.1	16	
Total Gate Charge	$Q_{G(TOT)}$	$V_{GS} = 5.0\text{ V}, V_{DS} = 24\text{ V}, I_D = 0.1\text{ A}$		1.15		nC
Threshold Gate Charge	$Q_{G(TH)}$			0.15		
Gate-to-Source Gate Charge	Q_{GS}			0.32		
Gate-to-Drain Charge	Q_{GD}			0.23		

SWITCHING CHARACTERISTICS (Note 4)

Turn-On Delay Time	$t_{d(on)}$	$V_{GS} = 4.5\text{ V}, V_{DD} = 5.0\text{ V}, I_D = 0.1\text{ A}, R_G = 50\ \Omega$		16.7		ns
Rise Time	t_r			47.9		
Turn-Off Delay Time	$t_{d(off)}$			65.1		
Fall Time	t_f			64.2		

SOURCE-DRAIN DIODE CHARACTERISTICS

Forward Diode Voltage	V_{SD}	$V_{GS} = 0\text{ V}, I_S = 10\text{ mA}$	$T_J = 25^\circ\text{C}$	0.65	0.7	V
			$T_J = 125^\circ\text{C}$	0.45		
Reverse Recovery Time	t_{RR}	$V_{GS} = 0\text{ V}, di_S/dt = 8\text{ A}/\mu\text{s}, I_S = 10\text{ mA}$		14		ns

Product parametric performance is indicated in the Electrical Characteristics for the listed test conditions, unless otherwise noted. Product performance may not be indicated by the Electrical Characteristics if operated under different conditions.

3. Pulse Test: pulse width $\leq 300\ \mu\text{s}$, duty cycle $\leq 2\%$.

4. Switching characteristics are independent of operating junction temperatures.

NTR4003N, NVR4003N

TYPICAL PERFORMANCE CURVES ($T_J = 25^\circ\text{C}$ unless otherwise noted)

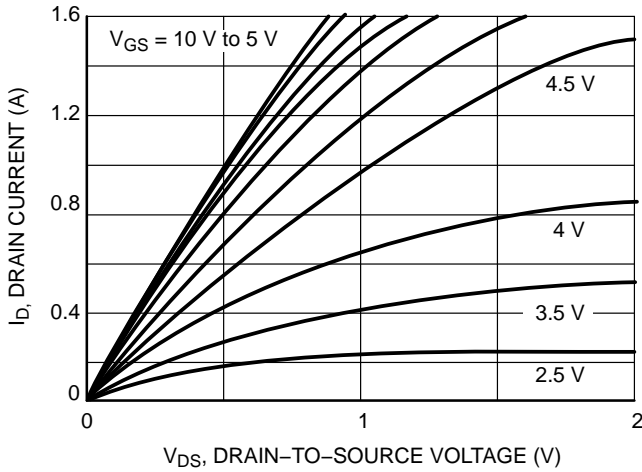

Figure 1. On-Region Characteristics

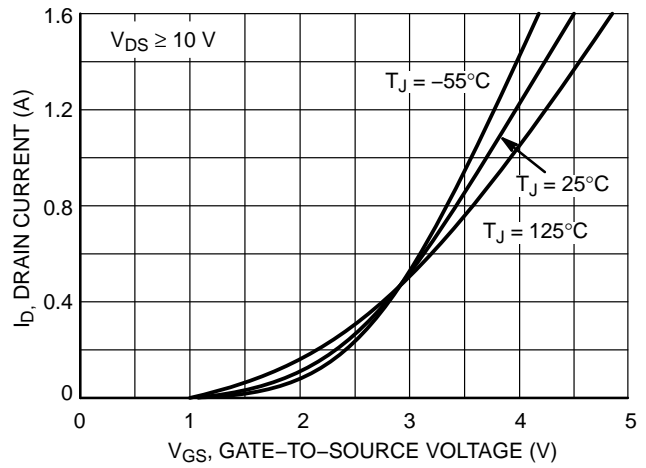

Figure 2. Transfer Characteristics

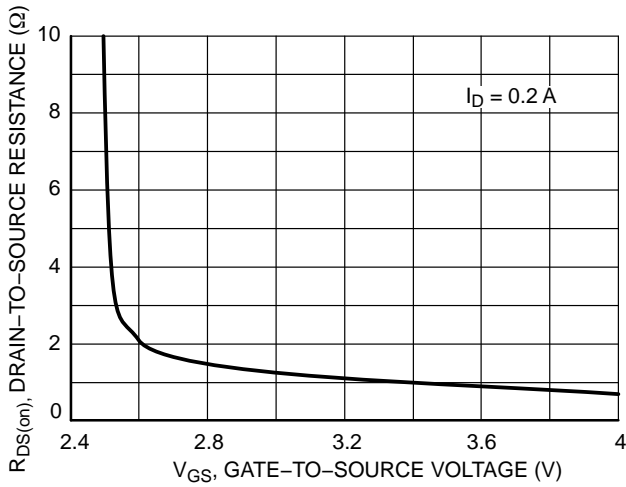

Figure 3. On-Resistance vs. Gate-to-Source Voltage

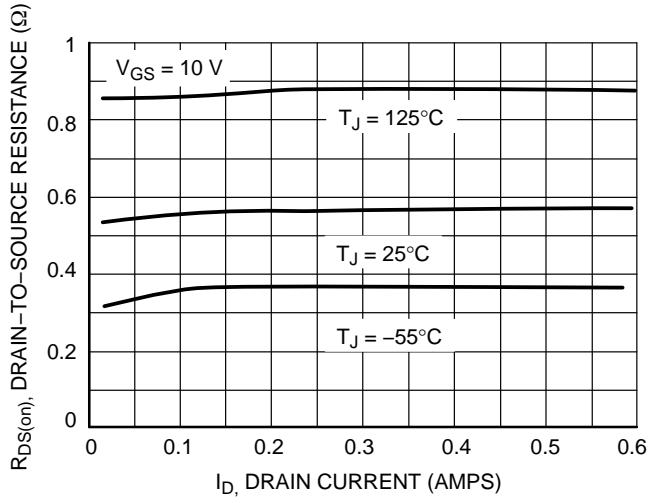

Figure 4. On-Resistance vs. Drain Current and Temperature

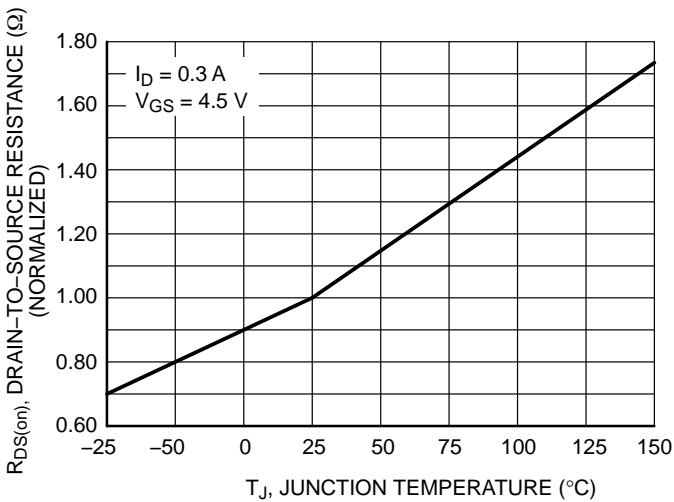

Figure 5. On-Resistance Variation with Temperature

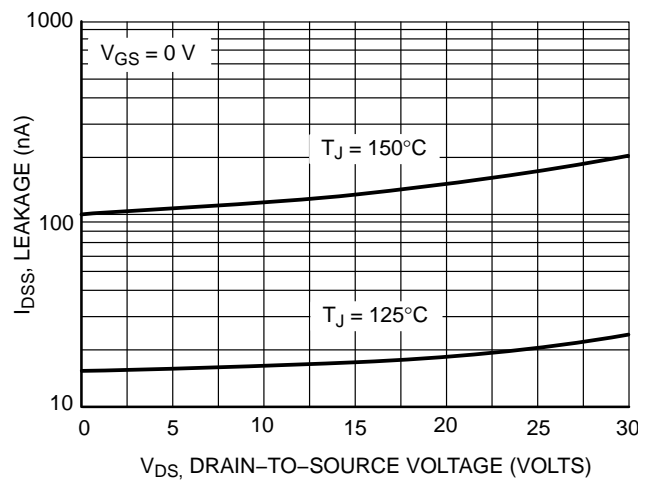

Figure 6. Drain-to-Source Leakage Current vs. Voltage

NTR4003N, NVR4003N

TYPICAL PERFORMANCE CURVES ($T_J = 25^\circ\text{C}$ unless otherwise noted)

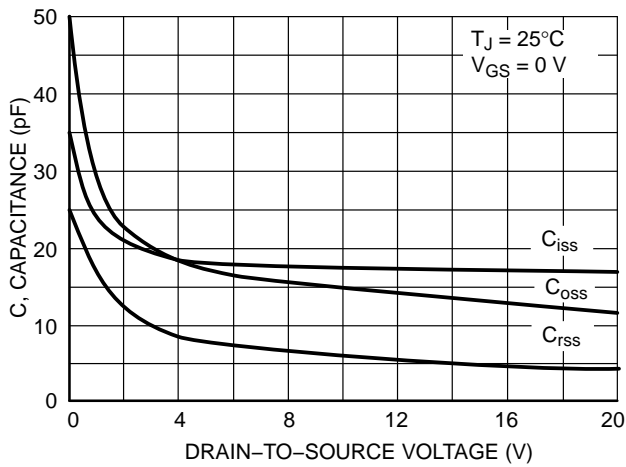

Figure 7. Capacitance Variation

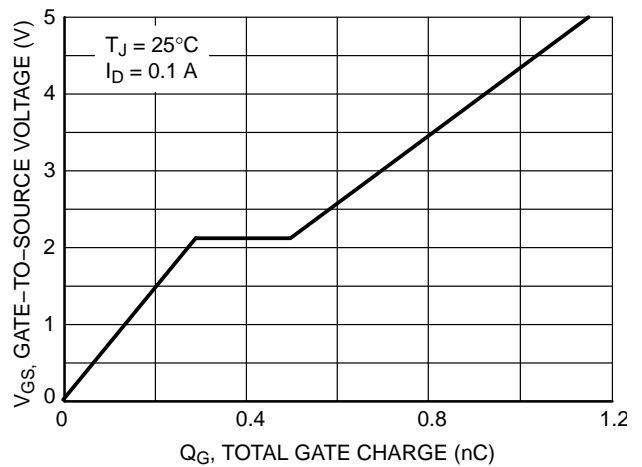

Figure 8. Gate-to-Source & Drain-to-Source Voltage vs. Total Charge

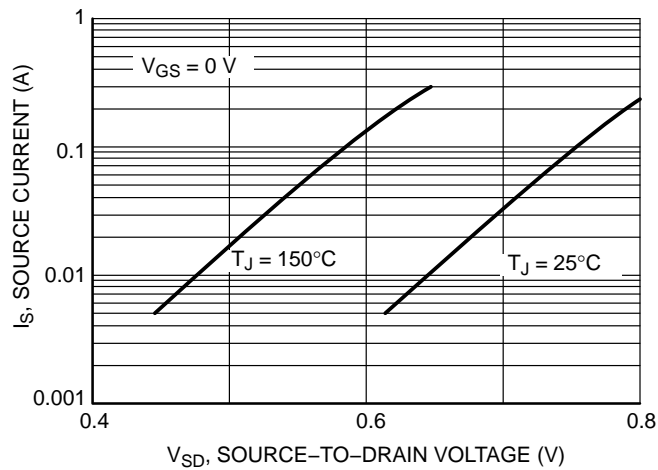
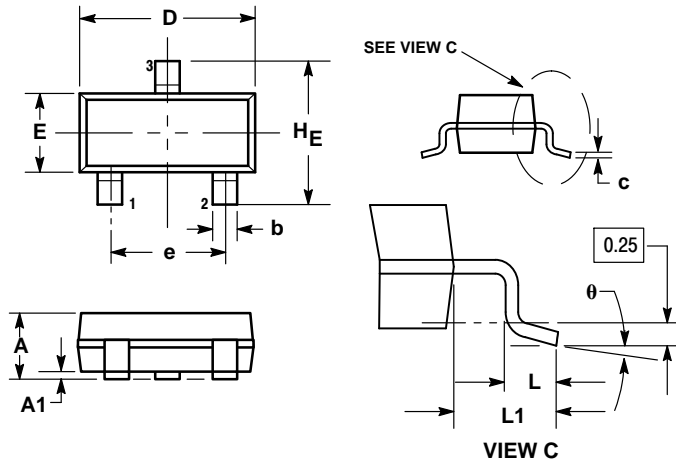

Figure 9. Diode Forward Voltage vs. Current

NTR4003N, NVR4003N

PACKAGE DIMENSIONS

SOT-23 (TO-236) CASE 318-08 ISSUE AP



- NOTES:
1. DIMENSIONING AND TOLERANCING PER ANSI Y14.5M, 1982.
 2. CONTROLLING DIMENSION: INCH.
 3. MAXIMUM LEAD THICKNESS INCLUDES LEAD FINISH THICKNESS. MINIMUM LEAD THICKNESS IS THE MINIMUM THICKNESS OF BASE MATERIAL.
 4. DIMENSIONS D AND E DO NOT INCLUDE MOLD FLASH, PROTRUSIONS, OR GATE BURRS.

DIM	MILLIMETERS			INCHES		
	MIN	NOM	MAX	MIN	NOM	MAX
A	0.89	1.00	1.11	0.035	0.040	0.044
A1	0.01	0.06	0.10	0.001	0.002	0.004
b	0.37	0.44	0.50	0.015	0.018	0.020
c	0.09	0.13	0.18	0.003	0.005	0.007
D	2.80	2.90	3.04	0.110	0.114	0.120
E	1.20	1.30	1.40	0.047	0.051	0.055
e	1.78	1.90	2.04	0.070	0.075	0.081
L	0.10	0.20	0.30	0.004	0.008	0.012
L1	0.35	0.54	0.69	0.014	0.021	0.029
HE	2.10	2.40	2.64	0.083	0.094	0.104
θ	0°	---	10°	0°	---	10°

- STYLE 21:
PIN 1. GATE
2. SOURCE
3. DRAIN

SOLDERING FOOTPRINT*

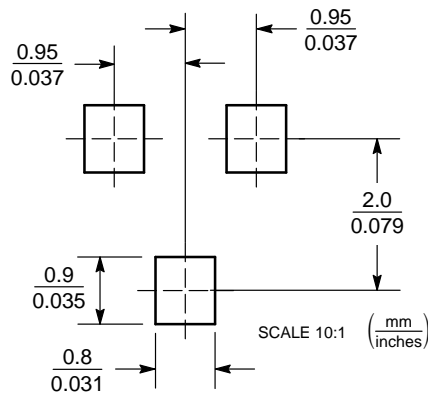

*For additional information on our Pb-Free strategy and soldering details, please download the ON Semiconductor Soldering and Mounting Techniques Reference Manual, SOLDERRM/D.

ON Semiconductor and the  are registered trademarks of Semiconductor Components Industries, LLC (SCILLC) or its subsidiaries in the United States and/or other countries. SCILLC owns the rights to a number of patents, trademarks, copyrights, trade secrets, and other intellectual property. A listing of SCILLC's product/patent coverage may be accessed at www.onsemi.com/site/pdf/Patent-Marking.pdf. SCILLC reserves the right to make changes without further notice to any products herein. SCILLC makes no warranty, representation or guarantee regarding the suitability of its products for any particular purpose, nor does SCILLC assume any liability arising out of the application or use of any product or circuit, and specifically disclaims any and all liability, including without limitation special, consequential or incidental damages. "Typical" parameters which may be provided in SCILLC data sheets and/or specifications can and do vary in different applications and actual performance may vary over time. All operating parameters, including "Typicals" must be validated for each customer application by customer's technical experts. SCILLC does not convey any license under its patent rights nor the rights of others. SCILLC products are not designed, intended, or authorized for use as components in systems intended for surgical implant into the body, or other applications intended to support or sustain life, or for any other application in which the failure of the SCILLC product could create a situation where personal injury or death may occur. Should Buyer purchase or use SCILLC products for any such unintended or unauthorized application, Buyer shall indemnify and hold SCILLC and its officers, employees, subsidiaries, affiliates, and distributors harmless against all claims, costs, damages, and expenses, and reasonable attorney fees arising out of, directly or indirectly, any claim of personal injury or death associated with such unintended or unauthorized use, even if such claim alleges that SCILLC was negligent regarding the design or manufacture of the part. SCILLC is an Equal Opportunity/Affirmative Action Employer. This literature is subject to all applicable copyright laws and is not for resale in any manner.

PUBLICATION ORDERING INFORMATION

LITERATURE FULFILLMENT:
Literature Distribution Center for ON Semiconductor
P.O. Box 5163, Denver, Colorado 80217 USA
Phone: 303-675-2175 or 800-344-3860 Toll Free USA/Canada
Fax: 303-675-2176 or 800-344-3867 Toll Free USA/Canada
Email: orderlit@onsemi.com

N. American Technical Support: 800-282-9855 Toll Free
USA/Canada
Europe, Middle East and Africa Technical Support:
Phone: 421 33 790 2910
Japan Customer Focus Center
Phone: 81-3-5817-1050

ON Semiconductor Website: www.onsemi.com
Order Literature: <http://www.onsemi.com/orderlit>
For additional information, please contact your local Sales Representative

NTR4003N/D

单击下面可查看定价，库存，交付和生命周期等信息

[>>MSKSEMI\(美森科\)](#)