

# MC74HC32A

## Quad 2-Input OR Gate

### High-Performance Silicon-Gate CMOS

The MC74HC32A is identical in pinout to the LS32. The device inputs are compatible with Standard CMOS outputs; with pullup resistors, they are compatible with LSTTL outputs.

#### Features

- Output Drive Capability: 10 LSTTL Loads
- Outputs Directly Interface to CMOS, NMOS and TTL
- Operating Voltage Range: 2.0 to 6.0 V
- Low Input Current: 1  $\mu$ A
- High Noise Immunity Characteristic of CMOS Devices
- In Compliance With the JEDEC Standard No. 7 A Requirements
- Chip Complexity: 48 FETs or 12 Equivalent Gates
- NLV Prefix for Automotive and Other Applications Requiring Unique Site and Control Change Requirements; AEC-Q100 Qualified and PPAP Capable
- These Devices are Pb-Free, Halogen Free/BFR Free and are RoHS Compliant

#### LOGIC DIAGRAM

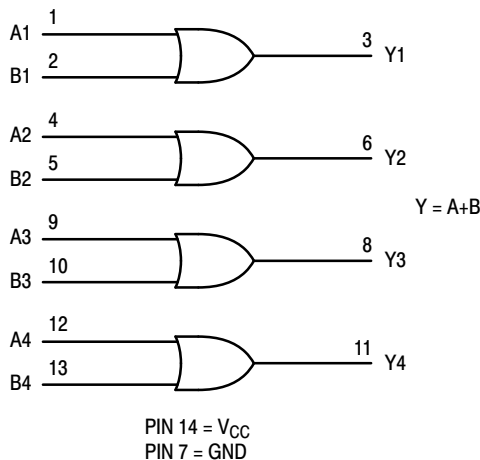

**ON Semiconductor**<sup>®</sup>

<http://onsemi.com>



**SOIC-14 NB  
D SUFFIX  
CASE 751A**



**TSSOP-14  
DT SUFFIX  
CASE 948G**

#### PIN ASSIGNMENT

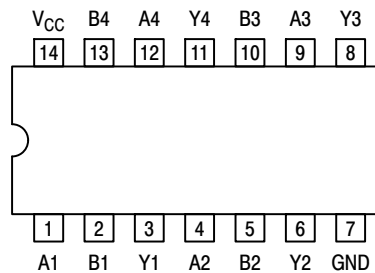

14-Lead (Top View)

#### MARKING DIAGRAMS

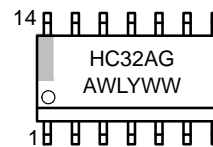

**SOIC-14 NB**

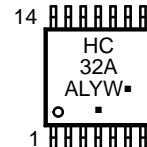

**TSSOP-14**

- A = Assembly Location
- L, WL = Wafer Lot
- Y, YY = Year
- W, WW = Work Week
- G or ■ = Pb-Free Package

(Note: Microdot may be in either location)

#### FUNCTION TABLE

Inputs		Output
A	B	Y
L	L	L
L	H	H
H	L	H
H	H	H

#### ORDERING INFORMATION

See detailed ordering and shipping information in the package dimensions section on page 5 of this data sheet.

# MC74HC32A

## MAXIMUM RATINGS

Symbol	Parameter	Value	Unit
$V_{CC}$	DC Supply Voltage (Referenced to GND)	-0.5 to +7.0	V
$V_{in}$	DC Input Voltage (Referenced to GND)	-0.5 to $V_{CC} + 0.5$	V
$V_{out}$	DC Output Voltage (Referenced to GND)	-0.5 to $V_{CC} + 0.5$	V
$I_{in}$	DC Input Current, per Pin	$\pm 20$	mA
$I_{out}$	DC Output Current, per Pin	$\pm 25$	mA
$I_{CC}$	DC Supply Current, $V_{CC}$ and GND Pins	$\pm 50$	mA
$P_D$	Power Dissipation in Still Air, SOIC Package† TSSOP Package†	500 450	mW
$T_{stg}$	Storage Temperature	-65 to +150	°C
$T_L$	Lead Temperature, 1 mm from Case for 10 Seconds Plastic DIP, SOIC or TSSOP Package	260	°C

This device contains protection circuitry to guard against damage due to high static voltages or electric fields. However, precautions must be taken to avoid applications of any voltage higher than maximum rated voltages to this high-impedance circuit. For proper operation,  $V_{in}$  and  $V_{out}$  should be constrained to the range  $GND \leq (V_{in} \text{ or } V_{out}) \leq V_{CC}$ . Unused inputs must always be tied to an appropriate logic voltage level (e.g., either GND or  $V_{CC}$ ). Unused outputs must be left open.

Stresses exceeding those listed in the Maximum Ratings table may damage the device. If any of these limits are exceeded, device functionality should not be assumed, damage may occur and reliability may be affected.

†Derating: SOIC Package: -7 mW/°C from 65° to 125°C  
TSSOP Package: -6.1 mW/°C from 65° to 125°C

## RECOMMENDED OPERATING CONDITIONS

Symbol	Parameter	Min	Max	Unit
$V_{CC}$	DC Supply Voltage (Referenced to GND)	2.0	6.0	V
$V_{in}, V_{out}$	DC Input Voltage, Output Voltage (Referenced to GND)	0	$V_{CC}$	V
$T_A$	Operating Temperature, All Package Types	-55	+125	°C
$t_r, t_f$	Input Rise and Fall Time (Figure 1)	$V_{CC} = 2.0 \text{ V}$ $V_{CC} = 4.5 \text{ V}$ $V_{CC} = 6.0 \text{ V}$	0 1000 500 400	ns

Functional operation above the stresses listed in the Recommended Operating Ranges is not implied. Extended exposure to stresses beyond the Recommended Operating Ranges limits may affect device reliability.

# MC74HC32A

## DC CHARACTERISTICS (Voltages Referenced to GND)

Symbol	Parameter	Condition	V <sub>CC</sub> V	Guaranteed Limit			Unit
				-55 to 25°C	≤85°C	≤125°C	
V <sub>IH</sub>	Minimum High-Level Input Voltage	V <sub>out</sub> = 0.1V or V <sub>CC</sub> - 0.1V  I <sub>out</sub>   ≤ 20μA	2.0	1.50	1.50	1.50	V
			3.0	2.10	2.10	2.10	
			4.5	3.15	3.15	3.15	
			6.0	4.20	4.20	4.20	
V <sub>IL</sub>	Maximum Low-Level Input Voltage	V <sub>out</sub> = 0.1V or V <sub>CC</sub> - 0.1V  I <sub>out</sub>   ≤ 20μA	2.0	0.50	0.50	0.50	V
			3.0	0.90	0.90	0.90	
			4.5	1.35	1.35	1.35	
			6.0	1.80	1.80	1.80	
V <sub>OH</sub>	Minimum High-Level Output Voltage	V <sub>in</sub> = V <sub>IH</sub> or V <sub>IL</sub>  I <sub>out</sub>   ≤ 20μA	2.0	1.9	1.9	1.9	V
			4.5	4.4	4.4	4.4	
			6.0	5.9	5.9	5.9	
		V <sub>in</sub> = V <sub>IH</sub> or V <sub>IL</sub>  I <sub>out</sub>   ≤ 2.4mA  I <sub>out</sub>   ≤ 4.0mA  I <sub>out</sub>   ≤ 5.2mA	3.0	2.48	2.34	2.20	
			4.5	3.98	3.84	3.70	
			6.0	5.48	5.34	5.20	
V <sub>OL</sub>	Maximum Low-Level Output Voltage	V <sub>in</sub> = V <sub>IH</sub> or V <sub>IL</sub>  I <sub>out</sub>   ≤ 20μA	2.0	0.1	0.1	0.1	V
			4.5	0.1	0.1	0.1	
			6.0	0.1	0.1	0.1	
		V <sub>in</sub> = V <sub>IH</sub> or V <sub>IL</sub>  I <sub>out</sub>   ≤ 2.4mA  I <sub>out</sub>   ≤ 4.0mA  I <sub>out</sub>   ≤ 5.2mA	3.0	0.26	0.33	0.40	
			4.5	0.26	0.33	0.40	
			6.0	0.26	0.33	0.40	
I <sub>in</sub>	Maximum Input Leakage Current	V <sub>in</sub> = V <sub>CC</sub> or GND	6.0	±0.1	±1.0	±1.0	μA
I <sub>CC</sub>	Maximum Quiescent Supply Current (per Package)	V <sub>in</sub> = V <sub>CC</sub> or GND I <sub>out</sub> = 0μA	6.0	1.0	10	40	μA

## AC CHARACTERISTICS (C<sub>L</sub> = 50pF, Input t<sub>r</sub> = t<sub>f</sub> = 6ns)

Symbol	Parameter	V <sub>CC</sub> V	Guaranteed Limit			Unit
			-55 to 25°C	≤85°C	≤125°C	
t <sub>PLH</sub> , t <sub>PHL</sub>	Maximum Propagation Delay, Input A or B to Output Y (Figures 1 and 2)	2.0	75	95	110	ns
		3.0	30	40	55	
		4.5	15	19	22	
		6.0	13	16	19	
t <sub>TLH</sub> , t <sub>THL</sub>	Maximum Output Transition Time, Any Output (Figures 1 and 2)	2.0	75	95	110	ns
		3.0	27	32	36	
		4.5	15	19	22	
		6.0	13	16	19	
C <sub>in</sub>	Maximum Input Capacitance		10	10	10	pF
C <sub>PD</sub>	Power Dissipation Capacitance (Per Buffer)*	Typical @ 25°C, V <sub>CC</sub> = 5.0 V, V <sub>EE</sub> = 0 V			pF	
		20				

\* Used to determine the no-load dynamic power consumption: P<sub>D</sub> = C<sub>PD</sub> V<sub>CC</sub><sup>2</sup>f + I<sub>CC</sub> V<sub>CC</sub>.

# MC74HC32A

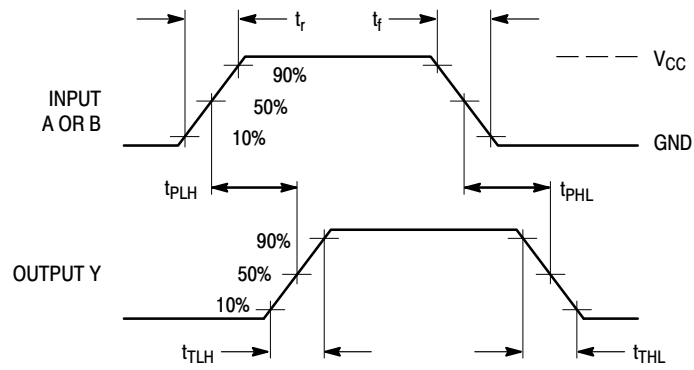
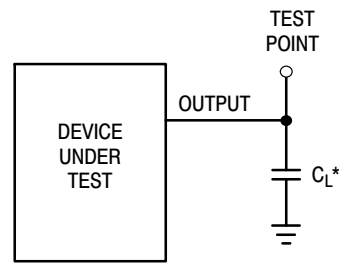

Figure 1. Switching Waveforms



\*Includes all probe and jig capacitance

Figure 2. Test Circuit

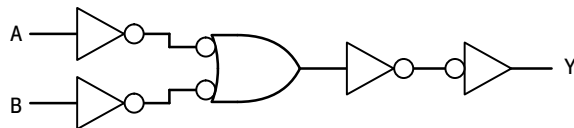

Figure 3. Expanded Logic Diagram  
(1/4 of the Device)

# MC74HC32A

## ORDERING INFORMATION

Device	Package	Shipping†
MC74HC32ADG	SOIC-14 NB (Pb-Free)	55 Units / Rail
MC74HC32ADR2G	SOIC-14 NB (Pb-Free)	2500 / Tape & Reel
MC74HC32ADTR2G	TSSOP-14 (Pb-Free)	2500 / Tape & Reel
NLV74HC32ADG*	SOIC-14 NB (Pb-Free)	55 Units / Rail
NLV74HC32ADR2G*	SOIC-14 NB (Pb-Free)	2500 / Tape & Reel
NLV74HC32ADTR2G*	TSSOP-14 (Pb-Free)	2500 / Tape & Reel

†For information on tape and reel specifications, including part orientation and tape sizes, please refer to our Tape and Reel Packaging Specifications Brochure, BRD8011/D.

\*NLV Prefix for Automotive and Other Applications Requiring Unique Site and Control Change Requirements; AEC-Q100 Qualified and PPAP Capable

# MECHANICAL CASE OUTLINE PACKAGE DIMENSIONS



SCALE 1:1

SOIC-14 NB  
CASE 751A-03  
ISSUE L

DATE 03 FEB 2016

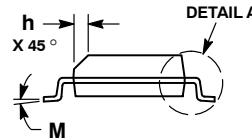

- NOTES:
1. DIMENSIONING AND TOLERANCING PER ASME Y14.5M, 1994.
  2. CONTROLLING DIMENSION: MILLIMETERS.
  3. DIMENSION b DOES NOT INCLUDE DAMBAR PROTRUSION. ALLOWABLE PROTRUSION SHALL BE 0.13 TOTAL IN EXCESS OF AT MAXIMUM MATERIAL CONDITION.
  4. DIMENSIONS D AND E DO NOT INCLUDE MOLD PROTRUSIONS.
  5. MAXIMUM MOLD PROTRUSION 0.15 PER SIDE.

DIM	MILLIMETERS		INCHES	
	MIN	MAX	MIN	MAX
A	1.35	1.75	0.054	0.068
A1	0.10	0.25	0.004	0.010
A3	0.19	0.25	0.008	0.010
b	0.35	0.49	0.014	0.019
D	8.55	8.75	0.337	0.344
E	3.80	4.00	0.150	0.157
e	1.27 BSC		0.050 BSC	
H	5.80	6.20	0.228	0.244
h	0.25	0.50	0.010	0.019
L	0.40	1.25	0.016	0.049
M	0°	7°	0°	7°

### SOLDERING FOOTPRINT\*



DIMENSIONS: MILLIMETERS

\*For additional information on our Pb-Free strategy and soldering details, please download the ON Semiconductor Soldering and Mounting Techniques Reference Manual, SOLDERRM/D.

### GENERIC MARKING DIAGRAM\*



- XXXXXX = Specific Device Code
- A = Assembly Location
- WL = Wafer Lot
- Y = Year
- WW = Work Week
- G = Pb-Free Package

\*This information is generic. Please refer to device data sheet for actual part marking. Pb-Free indicator, "G" or microdot "▪", may or may not be present. Some products may not follow the Generic Marking.

STYLES ON PAGE 2

DOCUMENT NUMBER:	98ASB42565B	Electronic versions are uncontrolled except when accessed directly from the Document Repository. Printed versions are uncontrolled except when stamped "CONTROLLED COPY" in red.
DESCRIPTION:	SOIC-14 NB	PAGE 1 OF 2

onsemi and ONsemi are trademarks of Semiconductor Components Industries, LLC dba onsemi or its subsidiaries in the United States and/or other countries. onsemi reserves the right to make changes without further notice to any products herein. onsemi makes no warranty, representation or guarantee regarding the suitability of its products for any particular purpose, nor does onsemi assume any liability arising out of the application or use of any product or circuit, and specifically disclaims any and all liability, including without limitation special, consequential or incidental damages. onsemi does not convey any license under its patent rights nor the rights of others.

**SOIC-14**  
**CASE 751A-03**  
**ISSUE L**

DATE 03 FEB 2016

STYLE 1:  
 PIN 1. COMMON CATHODE  
 2. ANODE/CATHODE  
 3. ANODE/CATHODE  
 4. NO CONNECTION  
 5. ANODE/CATHODE  
 6. NO CONNECTION  
 7. ANODE/CATHODE  
 8. ANODE/CATHODE  
 9. ANODE/CATHODE  
 10. NO CONNECTION  
 11. ANODE/CATHODE  
 12. ANODE/CATHODE  
 13. NO CONNECTION  
 14. COMMON ANODE

STYLE 2:  
 CANCELLED

STYLE 3:  
 PIN 1. NO CONNECTION  
 2. ANODE  
 3. ANODE  
 4. NO CONNECTION  
 5. ANODE  
 6. NO CONNECTION  
 7. ANODE  
 8. ANODE  
 9. ANODE  
 10. NO CONNECTION  
 11. ANODE  
 12. ANODE  
 13. NO CONNECTION  
 14. COMMON CATHODE

STYLE 4:  
 PIN 1. NO CONNECTION  
 2. CATHODE  
 3. CATHODE  
 4. NO CONNECTION  
 5. CATHODE  
 6. NO CONNECTION  
 7. CATHODE  
 8. CATHODE  
 9. CATHODE  
 10. NO CONNECTION  
 11. CATHODE  
 12. CATHODE  
 13. NO CONNECTION  
 14. COMMON ANODE

STYLE 5:  
 PIN 1. COMMON CATHODE  
 2. ANODE/CATHODE  
 3. ANODE/CATHODE  
 4. ANODE/CATHODE  
 5. ANODE/CATHODE  
 6. NO CONNECTION  
 7. COMMON ANODE  
 8. COMMON CATHODE  
 9. ANODE/CATHODE  
 10. ANODE/CATHODE  
 11. ANODE/CATHODE  
 12. ANODE/CATHODE  
 13. NO CONNECTION  
 14. COMMON ANODE

STYLE 6:  
 PIN 1. CATHODE  
 2. CATHODE  
 3. CATHODE  
 4. CATHODE  
 5. CATHODE  
 6. CATHODE  
 7. CATHODE  
 8. ANODE  
 9. ANODE  
 10. ANODE  
 11. ANODE  
 12. ANODE  
 13. ANODE  
 14. ANODE

STYLE 7:  
 PIN 1. ANODE/CATHODE  
 2. COMMON ANODE  
 3. COMMON CATHODE  
 4. ANODE/CATHODE  
 5. ANODE/CATHODE  
 6. ANODE/CATHODE  
 7. ANODE/CATHODE  
 8. ANODE/CATHODE  
 9. ANODE/CATHODE  
 10. ANODE/CATHODE  
 11. COMMON CATHODE  
 12. COMMON ANODE  
 13. ANODE/CATHODE  
 14. ANODE/CATHODE

STYLE 8:  
 PIN 1. COMMON CATHODE  
 2. ANODE/CATHODE  
 3. ANODE/CATHODE  
 4. NO CONNECTION  
 5. ANODE/CATHODE  
 6. ANODE/CATHODE  
 7. COMMON ANODE  
 8. COMMON ANODE  
 9. ANODE/CATHODE  
 10. ANODE/CATHODE  
 11. NO CONNECTION  
 12. ANODE/CATHODE  
 13. ANODE/CATHODE  
 14. COMMON CATHODE

<b>DOCUMENT NUMBER:</b>	<b>98ASB42565B</b>	Electronic versions are uncontrolled except when accessed directly from the Document Repository. Printed versions are uncontrolled except when stamped "CONTROLLED COPY" in red.
<b>DESCRIPTION:</b>	<b>SOIC-14 NB</b>	<b>PAGE 2 OF 2</b>

**onsemi** and **ONSEMI** are trademarks of Semiconductor Components Industries, LLC dba **onsemi** or its subsidiaries in the United States and/or other countries. **onsemi** reserves the right to make changes without further notice to any products herein. **onsemi** makes no warranty, representation or guarantee regarding the suitability of its products for any particular purpose, nor does **onsemi** assume any liability arising out of the application or use of any product or circuit, and specifically disclaims any and all liability, including without limitation special, consequential or incidental damages. **onsemi** does not convey any license under its patent rights nor the rights of others.

**onsemi**, **Onsemi**, and other names, marks, and brands are registered and/or common law trademarks of Semiconductor Components Industries, LLC dba "**onsemi**" or its affiliates and/or subsidiaries in the United States and/or other countries. **onsemi** owns the rights to a number of patents, trademarks, copyrights, trade secrets, and other intellectual property. A listing of **onsemi**'s product/patent coverage may be accessed at [www.onsemi.com/site/pdf/Patent-Marking.pdf](http://www.onsemi.com/site/pdf/Patent-Marking.pdf). **onsemi** reserves the right to make changes at any time to any products or information herein, without notice. The information herein is provided "as-is" and **onsemi** makes no warranty, representation or guarantee regarding the accuracy of the information, product features, availability, functionality, or suitability of its products for any particular purpose, nor does **onsemi** assume any liability arising out of the application or use of any product or circuit, and specifically disclaims any and all liability, including without limitation special, consequential or incidental damages. Buyer is responsible for its products and applications using **onsemi** products, including compliance with all laws, regulations and safety requirements or standards, regardless of any support or applications information provided by **onsemi**. "Typical" parameters which may be provided in **onsemi** data sheets and/or specifications can and do vary in different applications and actual performance may vary over time. All operating parameters, including "Typicals" must be validated for each customer application by customer's technical experts. **onsemi** does not convey any license under any of its intellectual property rights nor the rights of others. **onsemi** products are not designed, intended, or authorized for use as a critical component in life support systems or any FDA Class 3 medical devices or medical devices with a same or similar classification in a foreign jurisdiction or any devices intended for implantation in the human body. Should Buyer purchase or use **onsemi** products for any such unintended or unauthorized application, Buyer shall indemnify and hold **onsemi** and its officers, employees, subsidiaries, affiliates, and distributors harmless against all claims, costs, damages, and expenses, and reasonable attorney fees arising out of, directly or indirectly, any claim of personal injury or death associated with such unintended or unauthorized use, even if such claim alleges that **onsemi** was negligent regarding the design or manufacture of the part. **onsemi** is an Equal Opportunity/Affirmative Action Employer. This literature is subject to all applicable copyright laws and is not for resale in any manner.

#### ADDITIONAL INFORMATION

**TECHNICAL PUBLICATIONS:**

Technical Library: [www.onsemi.com/design/resources/technical-documentation](http://www.onsemi.com/design/resources/technical-documentation)  
onsemi Website: [www.onsemi.com](http://www.onsemi.com)

**ONLINE SUPPORT:** [www.onsemi.com/support](http://www.onsemi.com/support)

For additional information, please contact your local Sales Representative at [www.onsemi.com/support/sales](http://www.onsemi.com/support/sales)





单击下面可查看定价，库存，交付和生命周期等信息

[>>ON Semiconductor\(安森美\)](#)