

Single Schmitt-Trigger Inverter

MC74VHC1G14, MC74VHC1GT14

The MC74VHC1G14 / MC74VHC1GT14 is a single Schmitt-Trigger Inverter in tiny footprint packages. The MC74VHC1G14 has CMOS-level input thresholds while the MC74VHC1GT14 has TTL-level input thresholds.

The internal circuit is composed of three stages, including a buffered output which provides high noise immunity and stable output.

The input structures provide protection when voltages up to 5.5 V are applied, regardless of the supply voltage. This allows the device to be used to interface 5 V circuits to 3 V circuits. Some output structures also provide protection when $V_{CC} = 0$ V and when the output voltage exceeds V_{CC} . These input and output structures help prevent device destruction caused by supply voltage – input/output voltage mismatch, battery backup, hot insertion, etc.

Features

- Designed for 2.0 V to 5.5 V V_{CC} Operation
- 4.0 ns t_{PD} at 5 V (typ)
- Inputs/Outputs Over-Voltage Tolerant up to 5.5 V
- I_{OFF} Supports Partial Power Down Protection
- Source/Sink 8 mA at 3.0 V
- Available in SC-88A, SC-74A, TSOP-5, SOT-953 and UDFN6 Packages
- Chip Complexity < 100 FETs
- -Q Suffix for Automotive and Other Applications Requiring Unique Site and Control Change Requirements; AEC-Q100 Qualified and PPAP Capable
- These Devices are Pb-Free, Halogen Free/BFR Free and are RoHS Compliant

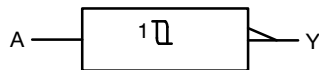

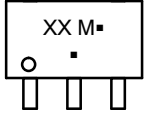

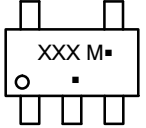

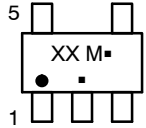
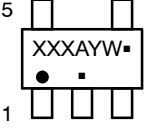

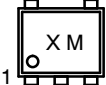







Figure 1. Logic Symbol

MARKING DIAGRAMS

	SC-88A DF SUFFIX CASE 419A	
	SC-74A DBV SUFFIX CASE 318BQ	
	TSOP-5 DT SUFFIX CASE 483	 
	SOT-953 P5 SUFFIX CASE 527AE	
	UDFN6 1.45 x 1.0 CASE 517AQ	
	UDFN6 1.2 x 1.0 CASE 517AA	
	UDFN6 1.0 x 1.0 CASE 517BX	

XX = Specific Device Code
M = Date Code*
▪ = Pb-Free Package

(Note: Microdot may be in either location)

*Date Code orientation and/or position may vary depending upon manufacturing location.

ORDERING INFORMATION

See detailed ordering, marking and shipping information in the package dimensions section on page 7 of this data sheet.

MC74VHC1G14, MC74VHC1GT14

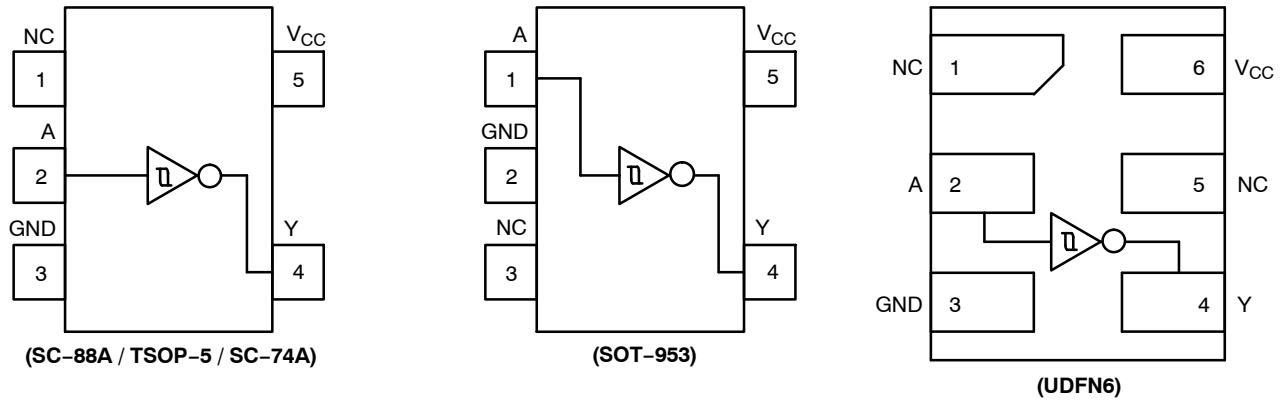

Figure 2. Pinout (Top View)

PIN ASSIGNMENT

(SC-88A / TSOP-5 / SC-74A)

Pin	Function
1	NC
2	A
3	GND
4	Y
5	V _{CC}

PIN ASSIGNMENT (SOT-953)

Pin	Function
1	A
2	GND
3	NC
4	Y
5	V _{CC}

PIN ASSIGNMENT (UDFN)

Pin	Function
1	NC
2	A
3	GND
4	Y
5	NC
6	V _{CC}

FUNCTION TABLE

A Input	Y Output
L	H
H	L

MC74VHC1G14, MC74VHC1GT14

MAXIMUM RATINGS

Symbol	Characteristics	Value	Unit	
V _{CC}	DC Supply Voltage	-0.5 to +6.5	V	
V _{IN}	DC Input Voltage	-0.5 to +6.5	V	
V _{OUT}	DC Output Voltage Active-Mode (High or Low State) Tri-State Mode (Note 1) Power-Down Mode (V _{CC} = 0 V)	-0.5 to V _{CC} + 0.5 -0.5 to +6.5 -0.5 to +6.5	V	
I _{IK}	DC Input Diode Current V _{IN} < GND	-20	mA	
I _{OK}	DC Output Diode Current V _{OUT} < GND	-20	mA	
I _{OUT}	DC Output Source/Sink Current	±25	mA	
I _{CC} or I _{GND}	DC Supply Current per Supply Pin or Ground Pin	±50	mA	
T _{STG}	Storage Temperature Range	-65 to +150	°C	
T _L	Lead Temperature, 1 mm from Case for 10 secs	260	°C	
T _J	Junction Temperature Under Bias	+150	°C	
θ _{JA}	Thermal Resistance (Note 2)	SC-88A SC-74A SOT-953 UDFN6	377 320 254 154	°C/W
P _D	Power Dissipation in Still Air	SC-88A SC-74A SOT-953 UDFN6	332 390 491 812	mW
MSL	Moisture Sensitivity	Level 1	-	
F _R	Flammability Rating Oxygen Index: 28 to 34	UL 94 V-0 @ 0.125 in	-	
V _{ESD}	ESD Withstand Voltage (Note 3) Human Body Model Charged Device Model	2000 1000	V	
I _{Latchup}	Latchup Performance (Note 4)	±100	mA	

Stresses exceeding those listed in the Maximum Ratings table may damage the device. If any of these limits are exceeded, device functionality should not be assumed, damage may occur and reliability may be affected.

1. Applicable to devices with outputs that may be tri-stated.
2. Measured with minimum pad spacing on an FR4 board, using 10mm-by-1inch, 2 ounce copper trace no air flow per JESD51-7.
3. HBM tested to ANSI/ESDA/JEDEC JS-001-2017. CDM tested to EIA/JESD22-C101-F. JEDEC recommends that ESD qualification to EIA/JESD22-A115-A (Machine Model) be discontinued per JEDEC/JEP172A.
4. Tested to EIA/JESD78 Class II.

RECOMMENDED OPERATING CONDITIONS

Symbol	Characteristics	Min	Max	Unit
V _{CC}	Positive DC Supply Voltage	2.0	5.5	V
V _{IN}	DC Input Voltage	0	5.5	V
V _{OUT}	DC Output Voltage Active-Mode (High or Low State) Tri-State Mode (Note 5) Power-Down Mode (V _{CC} = 0 V)	0 0 0	V _{CC} 5.5 5.5	V
T _A	Operating Temperature Range	-55	+125	°C
t _r , t _f	Input Rise and Fall Time V _{CC} = 2.0 V V _{CC} = 2.3 V to 2.7 V V _{CC} = 3.0 V to 3.6 V V _{CC} = 4.5 V to 5.5 V	0 0 0 0	No Limit No Limit No Limit No Limit	ns/V

Functional operation above the stresses listed in the Recommended Operating Ranges is not implied. Extended exposure to stresses beyond the Recommended Operating Ranges limits may affect device reliability.

5. Applicable to devices with outputs that may be tri-stated.

MC74VHC1G14, MC74VHC1GT14

DC ELECTRICAL CHARACTERISTICS (MC74VHC1G14)

Symbol	Parameter	Test Conditions	V _{CC} (V)	T _A = 25°C			-40°C ≤ T _A ≤ 85°C		-55°C ≤ T _A ≤ 125°C		Unit
				Min	Typ	Max	Min	Max	Min	Max	
V _{T+}	Positive Input Threshold Voltage		3.0	-	2.0	2.2	-	2.2	-	2.2	V
			4.5	-	3.0	3.15	-	3.15	-	3.15	
			5.5	-	3.6	3.85	-	3.85	-	3.85	
V _{T-}	Negative Input Threshold Voltage		3.0	0.9	1.5	-	0.9	-	0.9	-	V
			4.5	1.35	2.3	-	1.35	-	1.35	-	
			5.5	1.65	2.9	-	1.65	-	1.65	-	
V _H	Hysteresis Voltage		3.0	0.30	0.57	1.20	0.30	1.20	0.30	1.20	V
			4.5	0.40	0.67	1.40	0.40	1.40	0.40	1.40	
			5.5	0.50	0.74	1.60	0.50	1.60	0.50	1.60	
V _{OH}	High-Level Output Voltage	V _{IN} = V _{IH} or V _{IL}	2.0	1.9	2.0	-	1.9	-	1.9	-	V
		I _{OH} = -50 μA	3.0	2.9	3.0	-	2.9	-	2.9	-	
		I _{OH} = -50 μA	4.5	4.4	4.5	-	4.4	-	4.4	-	
		I _{OH} = -4 mA	3.0	2.58	-	-	2.48	-	2.34	-	
		I _{OH} = -8 mA	4.5	3.94	-	-	3.80	-	3.66	-	
V _{OL}	Low-Level Output Voltage	V _{IN} = V _{IH} or V _{IL}	2.0	-	0.0	0.1	-	0.1	-	0.1	V
		I _{OL} = 50 μA	3.0	-	0.0	0.1	-	0.1	-	0.1	
		I _{OL} = 50 μA	4.5	-	0.0	0.1	-	0.1	-	0.1	
		I _{OL} = 4 mA	3.0	-	-	0.36	-	0.44	-	0.52	
		I _{OL} = 8 mA	4.5	-	-	0.36	-	0.44	-	0.52	
I _{IN}	Input Leakage Current	V _{IN} = 5.5 V or GND	2.0 to 5.5	-	-	±0.1	-	±1.0	-	±1.0	μA
I _{OFF}	Power Off Leakage Current	V _{IN} = 5.5 V or V _{OUT} = 5.5 V	0.0	-	-	1.0	-	10	-	10	μA
I _{CC}	Quiescent Supply Current	V _{IN} = V _{CC} or GND	5.5	-	-	1.0	-	20	-	40	μA

MC74VHC1G14, MC74VHC1GT14

DC ELECTRICAL CHARACTERISTICS (MC74VHC1GT14)

Symbol	Parameter	Test Conditions	V _{CC} (V)	T _A = 25°C			-40°C ≤ T _A ≤ 85°C		-55°C ≤ T _A ≤ 125°C		Unit
				Min	Typ	Max	Min	Max	Min	Max	
V _{T+}	Positive Input Threshold Voltage		3.0	-	1.4	1.6	-	1.6	-	1.6	V
			4.5	-	1.74	2.0	-	2.0	-	2.0	
			5.5	-	1.94	2.1	-	2.1	-	2.1	
V _{T-}	Negative Input Threshold Voltage		3.0	0.35	0.76	-	0.35	-	0.35	-	V
			4.5	0.5	1.01	-	0.5	-	0.5	-	
			5.5	0.6	1.13	-	0.6	-	0.6	-	
V _H	Hysteresis Voltage		3.0	0.30	0.64	1.20	0.30	1.20	0.30	1.20	V
			4.5	0.40	0.73	1.40	0.40	1.40	0.40	1.40	
			5.5	0.50	0.81	1.60	0.50	1.60	0.50	1.60	
V _{OH}	High-Level Output Voltage	V _{IN} = V _{IH} or V _{IL}	2.0	1.9	2.0	-	1.9	-	1.9	-	V
		I _{OH} = -50 μA	3.0	2.9	3.0	-	2.9	-	2.9	-	
		I _{OH} = -50 μA	4.5	4.4	4.5	-	4.4	-	4.4	-	
		I _{OH} = -4 mA	3.0	2.58	-	-	2.48	-	2.34	-	
		I _{OH} = -8 mA	4.5	3.94	-	-	3.80	-	3.66	-	
V _{OL}	Low-Level Output Voltage	V _{IN} = V _{IH} or V _{IL}	2.0	-	0.0	0.1	-	0.1	-	0.1	V
		I _{OL} = 50 μA	3.0	-	0.0	0.1	-	0.1	-	0.1	
		I _{OL} = 50 μA	4.5	-	0.0	0.1	-	0.1	-	0.1	
		I _{OL} = 4 mA	3.0	-	-	0.36	-	0.44	-	0.52	
		I _{OL} = 8 mA	4.5	-	-	0.36	-	0.44	-	0.52	
I _{IN}	Input Leakage Current	V _{IN} = 5.5 V or GND	2.0 to 5.5	-	-	±0.1	-	±1.0	-	±1.0	μA
I _{OFF}	Power Off Leakage Current	V _{IN} = 5.5 V or V _{OUT} = 5.5 V	0	-	-	1.0	-	10	-	10	μA
I _{CC}	Quiescent Supply Current	V _{IN} = V _{CC} or GND	5.5	-	-	1.0	-	20	-	40	μA
I _{CC(T)}	Increase in Quiescent Supply Current per Input Pin	One Input: V _{IN} = 3.4 V; Other Input at V _{CC} or GND	5.5	-	-	1.35	-	1.5	-	1.65	mA

AC ELECTRICAL CHARACTERISTICS

Symbol	Parameter	Conditions	V _{CC} (V)	T _A = 25°C			-40°C ≤ T _A ≤ 85°C		-55°C ≤ T _A ≤ 125°C		Unit	
				Min	Typ	Max	Min	Max	Min	Max		
t _{PLH} , t _{PHL}	Propagation Delay, A to Y (Figures 3 and 4)	C _L = 15 pF	3.0 to 3.6	-	7.0	12.8	-	15.0	-	17.0	ns	
				-	8.5	16.3	-	18.5	-	20.5		
		C _L = 50 pF		4.5 to 5.5	-	4.0	8.6	-	10.0	-		11.5
				-	5.5	10.6	-	12.0	-	13.5		
C _{IN}	Input Capacitance			-	4.0	10	-	10	-	10	pF	
C _{OUT}	Output Capacitance	Output in High Impedance State		-	6.0	-	-	-	-	-	pF	

C _{PD}	Power Dissipation Capacitance (Note 6)	Typical @ 25°C, V_{CC} = 5.0 V	pF
		8.0	

6. C_{PD} is defined as the value of the internal equivalent capacitance which is calculated from the operating current consumption without load. Average operating current can be obtained by the equation: I_{CC(OPR)} = C_{PD} • V_{CC} • f_{in} + I_{CC}. C_{PD} is used to determine the no-load dynamic power consumption; P_D = C_{PD} • V_{CC}² • f_{in} + I_{CC} • V_{CC}.

MC74VHC1G14, MC74VHC1GT14



C_L includes probe and jig capacitance
 R_T is Z_{OUT} of pulse generator (typically 50 Ω)
 $f = 1$ MHz

Figure 3. Test Circuit

Test	Switch Position	C_L , pF	R_L , Ω
t_{PLH} / t_{PHL}	Open	See AC Characteristics Table	X
t_{PLZ} / t_{PZL}	V_{CC}		1 k
t_{PHZ} / t_{PZH}	GND		1 k

X = Don't Care



Figure 4. Switching Waveforms

V_{CC} , V	V_{mi} , V	V_{mo} , V		V_Y , V
		t_{PLH} , t_{PHL}	t_{PZL} , t_{PLZ} , t_{PZH} , t_{PHZ}	
3.0 to 3.6	$V_{CC}/2$	$V_{CC}/2$	$V_{CC}/2$	0.3
4.5 to 5.5	$V_{CC}/2$	$V_{CC}/2$	$V_{CC}/2$	0.3

MC74VHC1G14, MC74VHC1GT14

ORDERING INFORMATION

Device	Packages	Specific Device Code	Pin 1 Orientation (See below)	Shipping [†]
MC74VHC1G14DFT1G	SC-88A	VA	Q2	3000 / Tape & Reel
MC74VHC1G14DFT2G	SC-88A	VA	Q4	3000 / Tape & Reel
MC74VHC1G14DFT1G-Q*	SC-88A	VA	Q2	3000 / Tape & Reel
MC74VHC1G14DFT2G-Q*	SC-88A	VA	Q4	3000 / Tape & Reel
MC74VHC1GT14DFT1G	SC-88A	VC	Q2	3000 / Tape & Reel
MC74VHC1GT14DFT2G	SC-88A	VC	Q4	3000 / Tape & Reel
MC74VHC1GT14DFT1G-Q*	SC-88A	VC	Q2	3000 / Tape & Reel
MC74VHC1GT14DFT2G-Q*	SC-88A	VC	Q4	3000 / Tape & Reel
MC74VHC1G14DBVT1G	SC-74A	VA	Q4	3000 / Tape & Reel
MC74VHC1GT14DBVT1G	SC-74A	VC	Q4	3000 / Tape & Reel
MC7VHC1G14DTT1G-Q* (Please contact onsemi)	TSOP-5	VA	Q4	3000 / Tape & Reel
MC74VHC1G14P5T5G	SOT-953	R	Q2	8000 / Tape & Reel
MC74VHC1GT14P5T5G (Please contact onsemi)	SOT-953	TBD	Q2	8000 / Tape & Reel
MC74VHC1G14MU1TCG (Please contact onsemi)	UDFN6, 1.45 x 1.0, 0.5P	TBD	Q4	3000 / Tape & Reel
MC74VHC1GT14MU1TCG	UDFN6, 1.45 x 1.0, 0.5P	Q	Q4	3000 / Tape & Reel
MC74VHC1G14MU2TCG (Please contact onsemi)	UDFN6, 1.2 x 1.0, 0.4P	P	Q4	3000 / Tape & Reel
MC74VHC1GT14MU2TCG	UDFN6, 1.2 x 1.0, 0.4P	M	Q4	3000 / Tape & Reel
MC74VHC1G14MU3TCG (Please contact onsemi)	UDFN6, 1.0 x 1.0, 0.35	TBD	Q4	3000 / Tape & Reel
MC74VHC1GT14MU3TCG	UDFN6, 1.0 x 1.0, 0.35	M	Q4	3000 / Tape & Reel

†For information on tape and reel specifications, including part orientation and tape sizes, please refer to our Tape and Reel Packaging Specifications Brochure, BRD8011/D.

*-Q Suffix for Automotive and Other Applications Requiring Unique Site and Control Change Requirements; AEC-Q100 Qualified and PPAP Capable.

Pin 1 Orientation in Tape and Reel

Direction of Feed

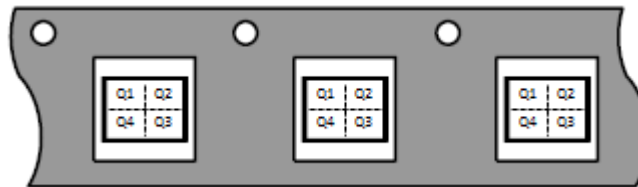

MECHANICAL CASE OUTLINE PACKAGE DIMENSIONS

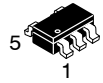

SCALE 2:1

SC-74A CASE 318BQ ISSUE B

DATE 18 JAN 2018

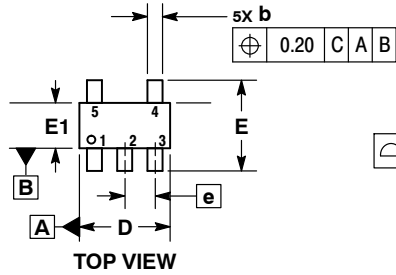

TOP VIEW

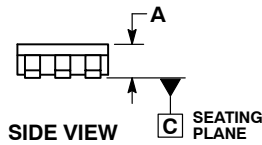

SIDE VIEW

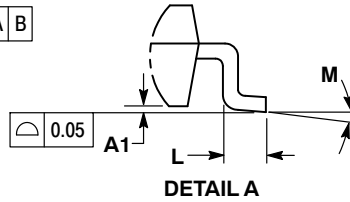

DETAIL A

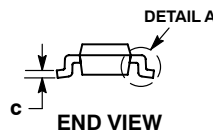

END VIEW

NOTES:

1. DIMENSIONING AND TOLERANCING PER ASME Y14.5M, 1994.
2. CONTROLLING DIMENSION: MILLIMETERS.
3. MAXIMUM LEAD THICKNESS INCLUDES LEAD FINISH THICKNESS. MINIMUM LEAD THICKNESS IS THE MINIMUM THICKNESS OF BASE MATERIAL.
4. DIMENSIONS A AND B DO NOT INCLUDE MOLD FLASH, PROTRUSIONS, OR GATE BURRS. MOLD FLASH, PROTRUSIONS, OR GATE BURRS SHALL NOT EXCEED 0.15 PER SIDE.

DIM	MILLIMETERS	
	MIN	MAX
A	0.90	1.10
A1	0.01	0.10
b	0.25	0.50
c	0.10	0.26
D	2.85	3.15
E	2.50	3.00
E1	1.35	1.65
e	0.95 BSC	
L	0.20	0.60
M	0°	10°

RECOMMENDED SOLDERING FOOTPRINT*

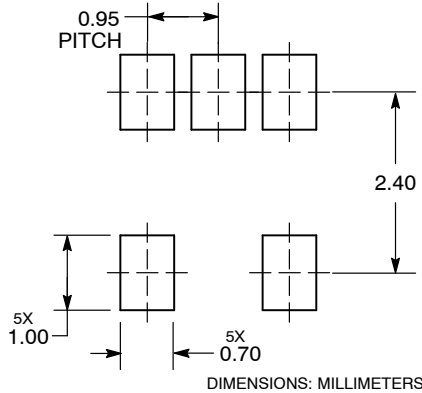

GENERIC MARKING DIAGRAM*

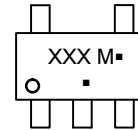

- XXX = Specific Device Code
- M = Date Code
- = Pb-Free Package

(Note: Microdot may be in either location)

*This information is generic. Please refer to device data sheet for actual part marking. Pb-Free indicator, "G" or microdot "▪", may or may not be present. Some products may not follow the Generic Marking.

*For additional information on our Pb-Free strategy and soldering details, please download the **onsemi** Soldering and Mounting Techniques Reference Manual, SOLDERRM/D.

DOCUMENT NUMBER:	98AON66279G	Electronic versions are uncontrolled except when accessed directly from the Document Repository. Printed versions are uncontrolled except when stamped "CONTROLLED COPY" in red.
DESCRIPTION:	SC-74A	PAGE 1 OF 1

onsemi and onsemi are trademarks of Semiconductor Components Industries, LLC dba onsemi or its subsidiaries in the United States and/or other countries. onsemi reserves the right to make changes without further notice to any products herein. onsemi makes no warranty, representation or guarantee regarding the suitability of its products for any particular purpose, nor does onsemi assume any liability arising out of the application or use of any product or circuit, and specifically disclaims any and all liability, including without limitation special, consequential or incidental damages. onsemi does not convey any license under its patent rights nor the rights of others.

MECHANICAL CASE OUTLINE PACKAGE DIMENSIONS



SCALE 2:1

SC-88A (SC-70-5/SOT-353) CASE 419A-02 ISSUE M

DATE 11 APR 2023

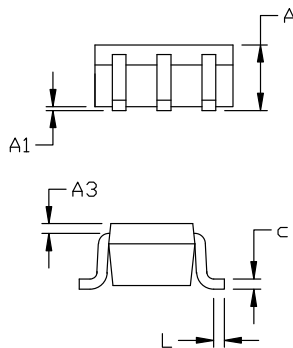

RECOMMENDED
MOUNTING FOOTPRINT

* For additional information on our Pb-Free strategy and soldering details, please download the ON Semiconductor Soldering and Mounting Techniques Reference Manual, SOLDERM/D.

NOTES:

1. DIMENSIONING AND TOLERANCING PER ANSI Y14.5M, 1982.
2. CONTROLLING DIMENSION: MILLIMETERS
3. 419A-01 OBSOLETE. NEW STANDARD 419A-02
4. DIMENSIONS D AND E1 DO NOT INCLUDE MOLD FLASH, PROTRUSIONS, OR GATE BURRS. MOLD FLASH, PROTRUSIONS, OR GATE BURRS SHALL NOT EXCEED 0.1016MM PER SIDE.

DIM	MILLIMETERS		
	MIN.	NOM.	MAX.
A	0.80	0.95	1.10
A1	---	---	0.10
A3	0.20 REF		
b	0.10	0.20	0.30
c	0.10	---	0.25
D	1.80	2.00	2.20
E	2.00	2.10	2.20
E1	1.15	1.25	1.35
e	0.65 BSC		
L	0.10	0.15	0.30

GENERIC MARKING DIAGRAM*

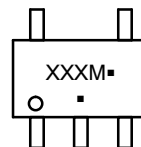

*This information is generic. Please refer to device data sheet for actual part marking. Pb-Free indicator, "G" or microdot "▪", may or may not be present. Some products may not follow the Generic Marking.

XXX = Specific Device Code

M = Date Code

▪ = Pb-Free Package

(Note: Microdot may be in either location)

STYLE 1:

1. BASE
2. EMITTER
3. BASE
4. COLLECTOR
5. COLLECTOR

STYLE 2:

1. ANODE
2. EMITTER
3. BASE
4. COLLECTOR
5. CATHODE

STYLE 3:

1. ANODE 1
2. N/C
3. ANODE 2
4. CATHODE 2
5. CATHODE 1

STYLE 4:

1. SOURCE 1
2. DRAIN 1/2
3. SOURCE 1
4. GATE 1
5. GATE 2

STYLE 5:

1. CATHODE
2. COMMON ANODE
3. CATHODE 2
4. CATHODE 3
5. CATHODE 4

STYLE 6:

1. EMITTER 2
2. BASE 2
3. EMITTER 1
4. COLLECTOR
5. COLLECTOR 2/BASE 1

STYLE 7:

1. BASE
2. EMITTER
3. BASE
4. COLLECTOR
5. COLLECTOR

STYLE 8:

1. CATHODE
2. COLLECTOR
3. N/C
4. BASE
5. EMITTER

STYLE 9:

1. ANODE
2. CATHODE
3. ANODE
4. ANODE
5. ANODE

Note: Please refer to datasheet for style callout. If style type is not called out in the datasheet refer to the device datasheet pinout or pin assignment.

DOCUMENT NUMBER:	98ASB42984B	Electronic versions are uncontrolled except when accessed directly from the Document Repository. Printed versions are uncontrolled except when stamped "CONTROLLED COPY" in red.
DESCRIPTION:	SC-88A (SC-70-5/SOT-353)	PAGE 1 OF 1

onsemi and ONSEMI are trademarks of Semiconductor Components Industries, LLC dba onsemi or its subsidiaries in the United States and/or other countries. onsemi reserves the right to make changes without further notice to any products herein. onsemi makes no warranty, representation or guarantee regarding the suitability of its products for any particular purpose, nor does onsemi assume any liability arising out of the application or use of any product or circuit, and specifically disclaims any and all liability, including without limitation special, consequential or incidental damages. onsemi does not convey any license under its patent rights nor the rights of others.

MECHANICAL CASE OUTLINE PACKAGE DIMENSIONS



UDFN6, 1.2x1.0, 0.4P
CASE 517AA
ISSUE D

DATE 03 SEP 2010



- NOTES:
1. DIMENSIONING AND TOLERANCING PER ASME Y14.5M, 1994.
 2. CONTROLLING DIMENSION: MILLIMETERS.
 3. DIMENSION b APPLIES TO PLATED TERMINAL AND IS MEASURED BETWEEN 0.25 AND 0.30 mm FROM TERMINAL.
 4. COPLANARITY APPLIES TO THE EXPOSED PAD AS WELL AS THE TERMINALS.

MILLIMETERS		
DIM	MIN	MAX
A	0.45	0.55
A1	0.00	0.05
A3	0.127	REF
b	0.15	0.25
D	1.20	BSC
E	1.00	BSC
e	0.40	BSC
L	0.30	0.40
L1	0.00	0.15
L2	0.40	0.50

GENERIC MARKING DIAGRAM*



X = Specific Device Code
M = Date Code

*This information is generic. Please refer to device data sheet for actual part marking. Pb-Free indicator, "G" or microdot "▪", may or may not be present.

MOUNTING FOOTPRINT*



DIMENSIONS: MILLIMETERS

*For additional information on our Pb-Free strategy and soldering details, please download the ON Semiconductor Soldering and Mounting Techniques Reference Manual, SOLDERRM/D.

DOCUMENT NUMBER:	98AON22068D	Electronic versions are uncontrolled except when accessed directly from the Document Repository. Printed versions are uncontrolled except when stamped "CONTROLLED COPY" in red.
DESCRIPTION:	6 PIN UDFN, 1.2X1.0, 0.4P	PAGE 1 OF 1

onsemi and ONsemi are trademarks of Semiconductor Components Industries, LLC dba onsemi or its subsidiaries in the United States and/or other countries. onsemi reserves the right to make changes without further notice to any products herein. onsemi makes no warranty, representation or guarantee regarding the suitability of its products for any particular purpose, nor does onsemi assume any liability arising out of the application or use of any product or circuit, and specifically disclaims any and all liability, including without limitation special, consequential or incidental damages. onsemi does not convey any license under its patent rights nor the rights of others.

MECHANICAL CASE OUTLINE PACKAGE DIMENSIONS



SCALE 4:1

UDFN6, 1.45x1.0, 0.5P
CASE 517AQ
ISSUE O

DATE 15 MAY 2008

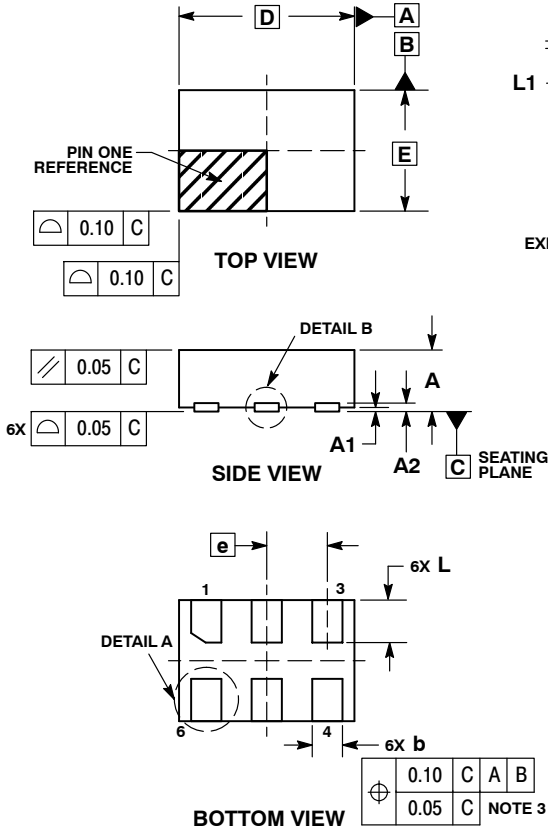

DETAIL A
OPTIONAL
CONSTRUCTIONS

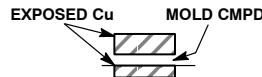

DETAIL B
OPTIONAL
CONSTRUCTIONS

NOTES:

1. DIMENSIONING AND TOLERANCING PER ASME Y14.5M, 1994.
2. CONTROLLING DIMENSION: MILLIMETERS.
3. DIMENSION b APPLIES TO PLATED TERMINAL AND IS MEASURED BETWEEN 0.15 AND 0.30 mm FROM THE TERMINAL TIP.

MILLIMETERS		
DIM	MIN	MAX
A	0.45	0.55
A1	0.00	0.05
A2	0.07	REF
b	0.20	0.30
D	1.45	BSC
E	1.00	BSC
e	0.50	BSC
L	0.30	0.40
L1	---	0.15

MOUNTING FOOTPRINT



DIMENSIONS: MILLIMETERS

*For additional information on our Pb-Free strategy and soldering details, please download the ON Semiconductor Soldering and Mounting Techniques Reference Manual, SOLDERRM/D.

**GENERIC
MARKING DIAGRAM***



X = Specific Device Code
M = Date Code

*This information is generic. Please refer to device data sheet for actual part marking. Pb-Free indicator, "G" or microdot "▪", may or may not be present.

DOCUMENT NUMBER:	98AON30313E	Electronic versions are uncontrolled except when accessed directly from the Document Repository. Printed versions are uncontrolled except when stamped "CONTROLLED COPY" in red.
DESCRIPTION:	UDFN6, 1.45x1.0, 0.5P	PAGE 1 OF 1

onsemi and ONSEMI are trademarks of Semiconductor Components Industries, LLC dba onsemi or its subsidiaries in the United States and/or other countries. onsemi reserves the right to make changes without further notice to any products herein. onsemi makes no warranty, representation or guarantee regarding the suitability of its products for any particular purpose, nor does onsemi assume any liability arising out of the application or use of any product or circuit, and specifically disclaims any and all liability, including without limitation special, consequential or incidental damages. onsemi does not convey any license under its patent rights nor the rights of others.

MECHANICAL CASE OUTLINE PACKAGE DIMENSIONS



UDFN6, 1x1, 0.35P
CASE 517BX
ISSUE O

SCALE 4:1

DATE 18 MAY 2011



- NOTES:
1. DIMENSIONING AND TOLERANCING PER ASME Y14.5M, 1994.
 2. CONTROLLING DIMENSION: MILLIMETERS.
 3. DIMENSION b APPLIES TO PLATED TERMINAL AND IS MEASURED BETWEEN 0.15 AND 0.20 MM FROM TERMINAL TIP.
 4. PACKAGE DIMENSIONS EXCLUSIVE OF BURRS AND MOLD FLASH.

MILLIMETERS		
DIM	MIN	MAX
A	0.45	0.55
A1	0.00	0.05
A3	0.13	REF
b	0.12	0.22
D	1.00	BSC
E	1.00	BSC
e	0.35	BSC
L	0.25	0.35
L1	0.30	0.40

RECOMMENDED SOLDERING FOOTPRINT*



*For additional information on our Pb-Free strategy and soldering details, please download the ON Semiconductor Soldering and Mounting Techniques Reference Manual, SOLDERRM/D.

GENERIC MARKING DIAGRAM*



X = Specific Device Code
M = Date Code

*This information is generic. Please refer to device data sheet for actual part marking. Pb-Free indicator, "G" or microdot "▪", may or may not be present. Some products may not follow the Generic Marking.

DOCUMENT NUMBER:	98AON56787E	Electronic versions are uncontrolled except when accessed directly from the Document Repository. Printed versions are uncontrolled except when stamped "CONTROLLED COPY" in red.
DESCRIPTION:	UDFN6, 1x1, 0.35P	PAGE 1 OF 1

onsemi and ONSEMI are trademarks of Semiconductor Components Industries, LLC dba onsemi or its subsidiaries in the United States and/or other countries. onsemi reserves the right to make changes without further notice to any products herein. onsemi makes no warranty, representation or guarantee regarding the suitability of its products for any particular purpose, nor does onsemi assume any liability arising out of the application or use of any product or circuit, and specifically disclaims any and all liability, including without limitation special, consequential or incidental damages. onsemi does not convey any license under its patent rights nor the rights of others.

MECHANICAL CASE OUTLINE PACKAGE DIMENSIONS



SCALE 4:1

SOT-953
CASE 527AE
ISSUE E

DATE 02 AUG 2011

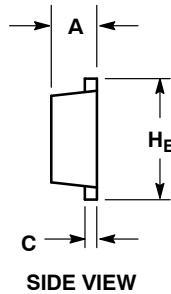
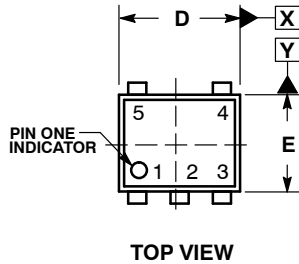

NOTES:

1. DIMENSIONING AND TOLERANCING PER ASME Y14.5M, 1994.
2. CONTROLLING DIMENSION: MILLIMETERS
3. MAXIMUM LEAD THICKNESS INCLUDES LEAD FINISH. MINIMUM LEAD THICKNESS IS THE MINIMUM THICKNESS OF THE BASE MATERIAL.
4. DIMENSIONS D AND E DO NOT INCLUDE MOLD FLASH, PROTRUSIONS, OR GATE BURRS.

MILLIMETERS			
DIM	MIN	NOM	MAX
A	0.34	0.37	0.40
b	0.10	0.15	0.20
C	0.07	0.12	0.17
D	0.95	1.00	1.05
E	0.75	0.80	0.85
e	0.35 BSC		
H _E	0.95	1.00	1.05
L	0.175 REF		
L2	0.05	0.10	0.15
L3	---	---	0.15

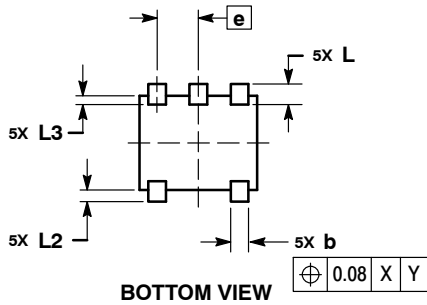

**RECOMMENDED
SOLDERING FOOTPRINT***

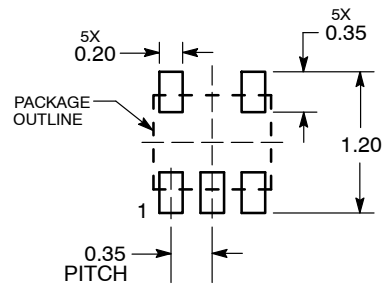

DIMENSIONS: MILLIMETERS

**GENERIC
MARKING DIAGRAM***

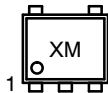

X = Specific Device Code
M = Month Code

*This information is generic. Please refer to device data sheet for actual part marking. Pb-Free indicator, "G" or microdot "•", may or may not be present. Some products may not follow the Generic Marking.

*For additional information on our Pb-Free strategy and soldering details, please download the **onsemi** Soldering and Mounting Techniques Reference Manual, SOLDERRM/D.

DOCUMENT NUMBER:	98AON26457D	Electronic versions are uncontrolled except when accessed directly from the Document Repository. Printed versions are uncontrolled except when stamped "CONTROLLED COPY" in red.
DESCRIPTION:	SOT-953	PAGE 1 OF 1

onsemi and **ONSEMI** are trademarks of Semiconductor Components Industries, LLC dba **onsemi** or its subsidiaries in the United States and/or other countries. **onsemi** reserves the right to make changes without further notice to any products herein. **onsemi** makes no warranty, representation or guarantee regarding the suitability of its products for any particular purpose, nor does **onsemi** assume any liability arising out of the application or use of any product or circuit, and specifically disclaims any and all liability, including without limitation special, consequential or incidental damages. **onsemi** does not convey any license under its patent rights nor the rights of others.

onsemi, **Onsemi**, and other names, marks, and brands are registered and/or common law trademarks of Semiconductor Components Industries, LLC dba "**onsemi**" or its affiliates and/or subsidiaries in the United States and/or other countries. **onsemi** owns the rights to a number of patents, trademarks, copyrights, trade secrets, and other intellectual property. A listing of **onsemi**'s product/patent coverage may be accessed at www.onsemi.com/site/pdf/Patent-Marking.pdf. **onsemi** reserves the right to make changes at any time to any products or information herein, without notice. The information herein is provided "as-is" and **onsemi** makes no warranty, representation or guarantee regarding the accuracy of the information, product features, availability, functionality, or suitability of its products for any particular purpose, nor does **onsemi** assume any liability arising out of the application or use of any product or circuit, and specifically disclaims any and all liability, including without limitation special, consequential or incidental damages. Buyer is responsible for its products and applications using **onsemi** products, including compliance with all laws, regulations and safety requirements or standards, regardless of any support or applications information provided by **onsemi**. "Typical" parameters which may be provided in **onsemi** data sheets and/or specifications can and do vary in different applications and actual performance may vary over time. All operating parameters, including "Typicals" must be validated for each customer application by customer's technical experts. **onsemi** does not convey any license under any of its intellectual property rights nor the rights of others. **onsemi** products are not designed, intended, or authorized for use as a critical component in life support systems or any FDA Class 3 medical devices or medical devices with a same or similar classification in a foreign jurisdiction or any devices intended for implantation in the human body. Should Buyer purchase or use **onsemi** products for any such unintended or unauthorized application, Buyer shall indemnify and hold **onsemi** and its officers, employees, subsidiaries, affiliates, and distributors harmless against all claims, costs, damages, and expenses, and reasonable attorney fees arising out of, directly or indirectly, any claim of personal injury or death associated with such unintended or unauthorized use, even if such claim alleges that **onsemi** was negligent regarding the design or manufacture of the part. **onsemi** is an Equal Opportunity/Affirmative Action Employer. This literature is subject to all applicable copyright laws and is not for resale in any manner.

ADDITIONAL INFORMATION

TECHNICAL PUBLICATIONS:

Technical Library: www.onsemi.com/design/resources/technical-documentation
onsemi Website: www.onsemi.com

ONLINE SUPPORT: www.onsemi.com/support

For additional information, please contact your local Sales Representative at www.onsemi.com/support/sales



单击下面可查看定价，库存，交付和生命周期等信息

[>>ON Semiconductor\(安森美\)](#)