

General Purpose Transistors

NPN Silicon

BC846ALT1G Series

Features

- Moisture Sensitivity Level: 1
- ESD Rating – Human Body Model: > 4000 V
– Machine Model: > 400 V
- S and NSV Prefix for Automotive and Other Applications Requiring Unique Site and Control Change Requirements; AEC-Q101 Qualified and PPAP Capable
- These Devices are Pb-Free, Halogen Free/BFR Free and are RoHS Compliant

MAXIMUM RATINGS

Rating	Symbol	Value	Unit
Collector-Emitter Voltage BC846 BC847, BC850 BC848, BC849	V_{CEO}	65 45 30	Vdc
Collector-Base Voltage BC846 BC847, BC850 BC848, BC849	V_{CBO}	80 50 30	Vdc
Emitter-Base Voltage BC846 BC847, BC850 BC848, BC849	V_{EBO}	6.0 6.0 5.0	Vdc
Collector Current – Continuous	I_C	100	mAdc

Stresses exceeding those listed in the Maximum Ratings table may damage the device. If any of these limits are exceeded, device functionality should not be assumed, damage may occur and reliability may be affected.

THERMAL CHARACTERISTICS

Characteristic	Symbol	Max	Unit
Total Device Dissipation FR-5 Board, (Note 1) $T_A = 25^\circ\text{C}$ Derate above 25°C	P_D	225 1.8	mW mW/°C
Thermal Resistance, Junction-to-Ambient (Note 1)	$R_{\theta JA}$	556	°C/W
Total Device Dissipation Alumina Substrate (Note 2) $T_A = 25^\circ\text{C}$ Derate above 25°C	P_D	300 2.4	mW mW/°C
Thermal Resistance, Junction-to-Ambient (Note 2)	$R_{\theta JA}$	417	°C/W
Junction and Storage Temperature Range	T_J, T_{stg}	-55 to +150	°C

- FR-5 = 1.0 × 0.75 × 0.062 in.
- Alumina = 0.4 × 0.3 × 0.024 in 99.5% alumina.

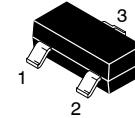
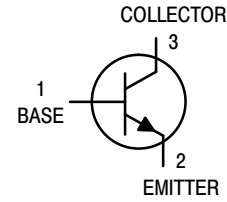

SOT-23
CASE 318
STYLE 6

MARKING DIAGRAM

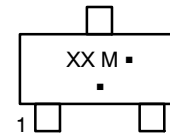

- XX = Device Code
- M = Date Code*
- = Pb-Free Package

(Note: Microdot may be in either location)

*Date Code orientation and/or overbar may vary depending upon manufacturing location.

ORDERING INFORMATION

See detailed ordering and shipping information in the package dimensions section on page 12 of this data sheet.

BC846ALT1G Series

ELECTRICAL CHARACTERISTICS ($T_A = 25^\circ\text{C}$ unless otherwise noted)

Characteristic	Symbol	Min	Typ	Max	Unit	
OFF CHARACTERISTICS						
Collector – Emitter Breakdown Voltage ($I_C = 10\text{ mA}$)	BC846A, B, C BC847A, B, C, BC850B, C BC848A, B, C, BC849B, C	$V_{(BR)CEO}$	65 45 30	– – –	– – –	V
Collector – Emitter Breakdown Voltage ($I_C = 10\ \mu\text{A}$, $V_{EB} = 0$)	BC846A, B, C BC847A, B, C, BC850B, C BC848A, B, C, BC849B, C	$V_{(BR)CES}$	80 50 30	– – –	– – –	V
Collector – Base Breakdown Voltage ($I_C = 10\ \mu\text{A}$)	BC846A, B, C BC847A, B, C, BC850B, C BC848A, B, C, BC849B, C	$V_{(BR)CBO}$	80 50 30	– – –	– – –	V
Emitter – Base Breakdown Voltage ($I_E = 1.0\ \mu\text{A}$)	BC846A, B, C BC847A, B, C, BC850B, C BC848A, B, C, BC849B, C	$V_{(BR)EBO}$	6.0 6.0 5.0	– – –	– – –	V
Collector Cutoff Current ($V_{CB} = 30\text{ V}$) ($V_{CB} = 30\text{ V}$, $T_A = 150^\circ\text{C}$)		I_{CBO}	– –	– –	15 5.0	nA μA
ON CHARACTERISTICS						
DC Current Gain ($I_C = 10\ \mu\text{A}$, $V_{CE} = 5.0\text{ V}$)	BC846A, BC847A, BC848A BC846B, BC847B, BC848B BC846C, BC847C, BC848C	h_{FE}	– – –	90 150 270	– – –	–
($I_C = 2.0\text{ mA}$, $V_{CE} = 5.0\text{ V}$)	BC846A, BC847A, BC848A BC846B, BC847B, BC848B, BC849B, BC850B BC846C, BC847C, BC848C, BC849C, BC850C		110 200 420	180 290 520	220 450 800	
Collector – Emitter Saturation Voltage ($I_C = 10\text{ mA}$, $I_B = 0.5\text{ mA}$) ($I_C = 100\text{ mA}$, $I_B = 5.0\text{ mA}$)		$V_{CE(sat)}$	– –	– –	0.25 0.6	V
Base – Emitter Saturation Voltage ($I_C = 10\text{ mA}$, $I_B = 0.5\text{ mA}$) ($I_C = 100\text{ mA}$, $I_B = 5.0\text{ mA}$)		$V_{BE(sat)}$	– –	0.7 0.9	– –	V
Base – Emitter Voltage ($I_C = 2.0\text{ mA}$, $V_{CE} = 5.0\text{ V}$) ($I_C = 10\text{ mA}$, $V_{CE} = 5.0\text{ V}$)		$V_{BE(on)}$	580 –	660 –	700 770	mV
SMALL-SIGNAL CHARACTERISTICS						
Current – Gain – Bandwidth Product ($I_C = 10\text{ mA}$, $V_{CE} = 5.0\text{ Vdc}$, $f = 100\text{ MHz}$)		f_T	100	–	–	MHz
Output Capacitance ($V_{CB} = 10\text{ V}$, $f = 1.0\text{ MHz}$)		C_{obo}	–	–	4.5	pF
Noise Figure ($I_C = 0.2\text{ mA}$, $V_{CE} = 5.0\text{ Vdc}$, $R_S = 2.0\text{ k}\Omega$, $f = 1.0\text{ kHz}$, $BW = 200\text{ Hz}$)	BC846A,B,C, BC847A,B,C, BC848A,B,C BC849B,C, BC850B,C	NF	– –	– –	10 4.0	dB

Product parametric performance is indicated in the Electrical Characteristics for the listed test conditions, unless otherwise noted. Product performance may not be indicated by the Electrical Characteristics if operated under different conditions.

BC846ALT1G Series

BC846A, BC847A, BC848A, SBC846A

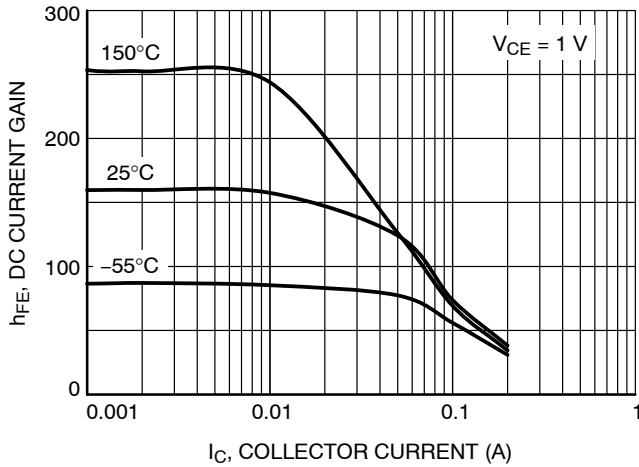

Figure 1. DC Current Gain vs. Collector Current



Figure 2. DC Current Gain vs. Collector Current



Figure 3. Collector Emitter Saturation Voltage vs. Collector Current

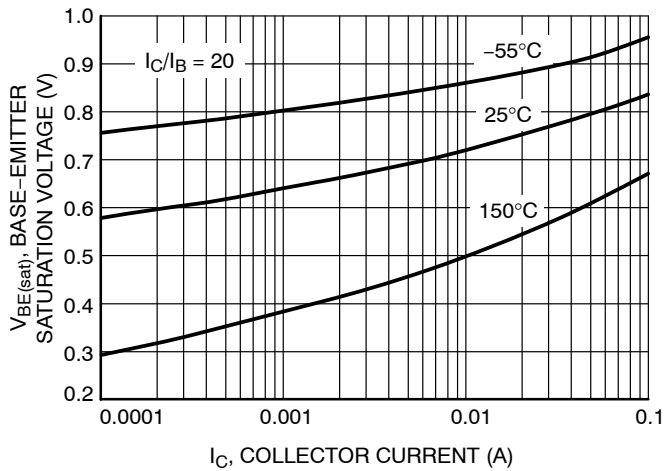

Figure 4. Base Emitter Saturation Voltage vs. Collector Current



Figure 5. Base Emitter Voltage vs. Collector Current

BC846ALT1G Series

BC846A, BC847A, BC848A, SBC846A

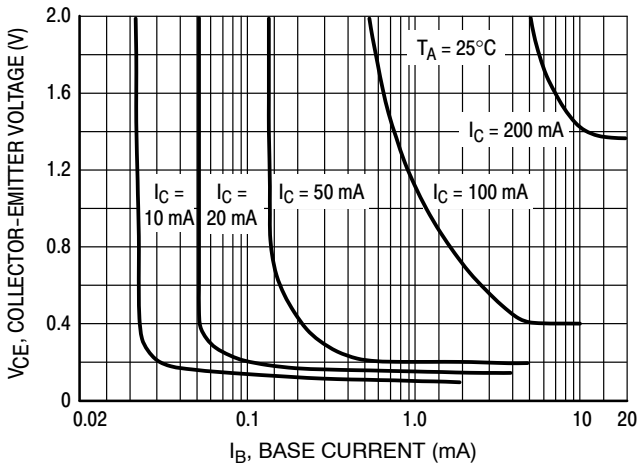

Figure 6. Collector Saturation Region



Figure 7. Base-Emitter Temperature Coefficient

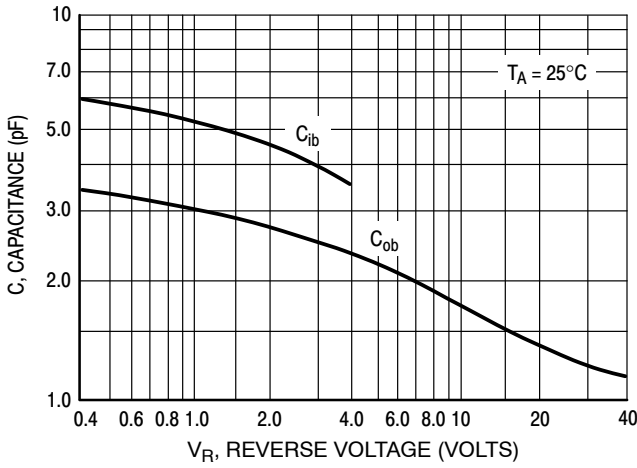

Figure 8. Capacitances

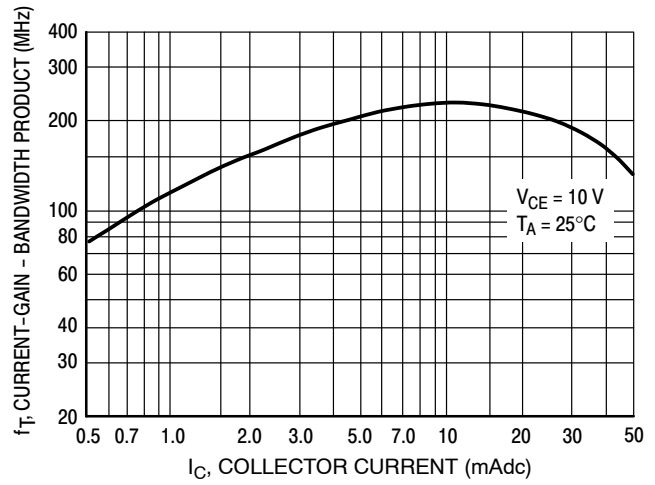

Figure 9. Current-Gain - Bandwidth Product

BC846ALT1G Series

BC846B, SBC846B

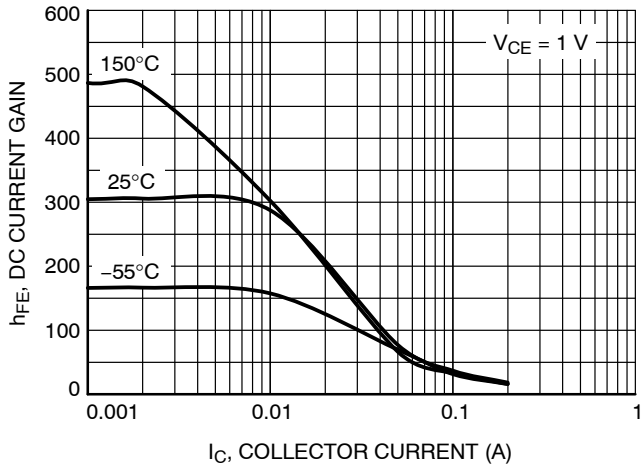

Figure 10. DC Current Gain vs. Collector Current

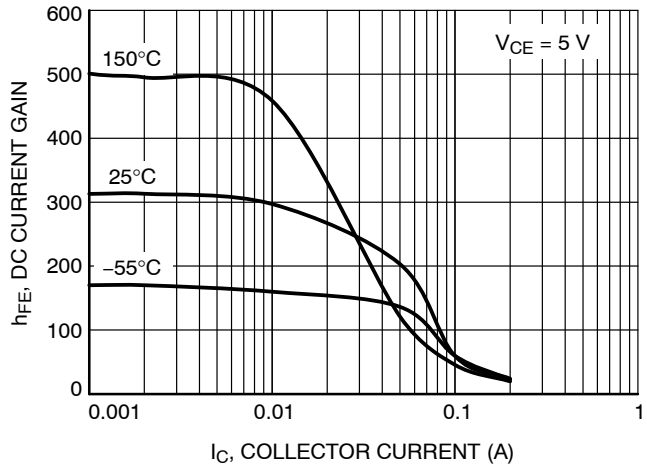

Figure 11. DC Current Gain vs. Collector Current



Figure 12. Collector Emitter Saturation Voltage vs. Collector Current



Figure 13. Base Emitter Saturation Voltage vs. Collector Current

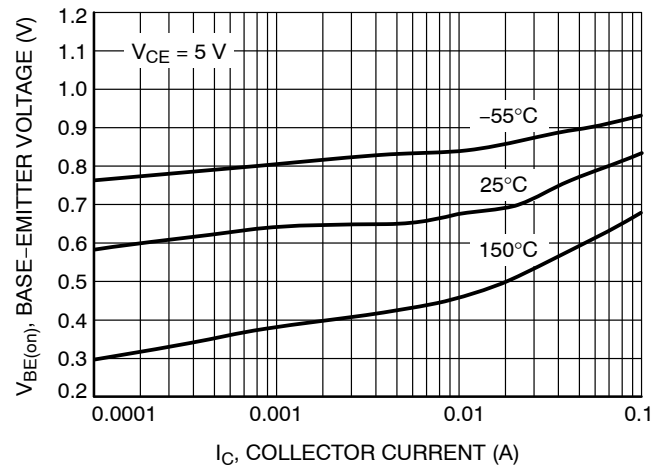

Figure 14. Base Emitter Voltage vs. Collector Current

BC846ALT1G Series

BC846B, SBC846B

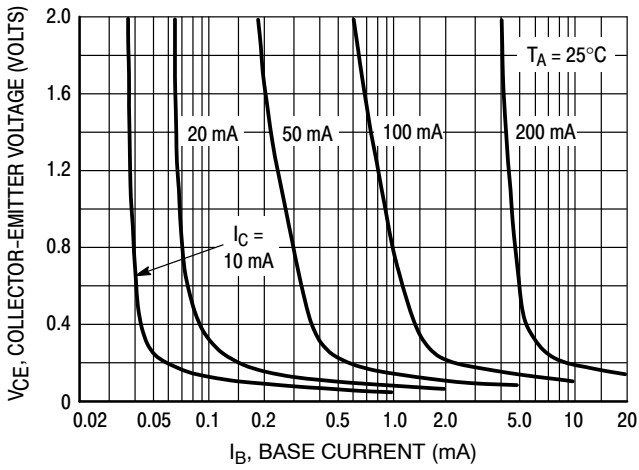

Figure 15. Collector Saturation Region



Figure 16. Base-Emitter Temperature Coefficient

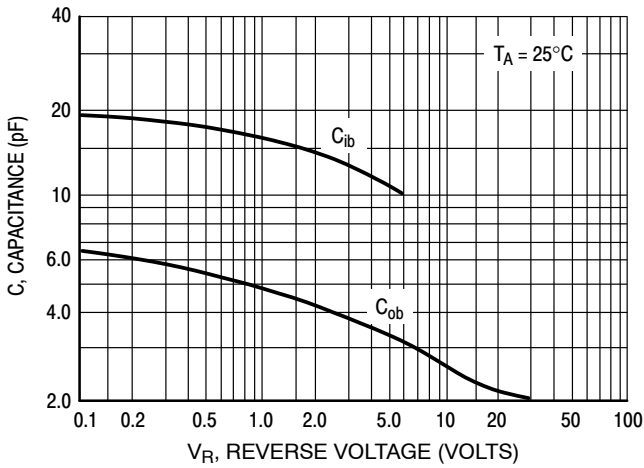

Figure 17. Capacitance

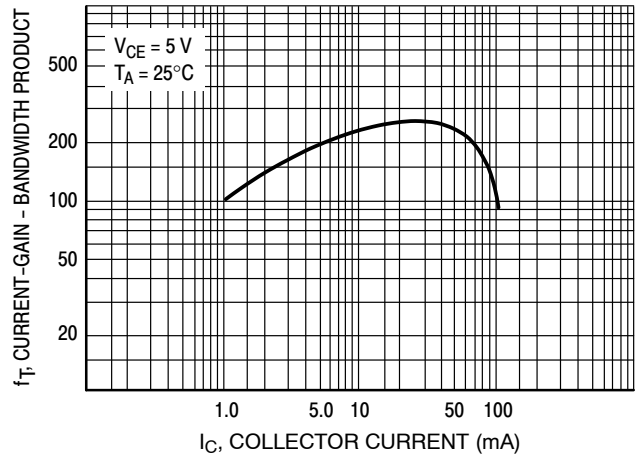

Figure 18. Current-Gain - Bandwidth Product

BC846ALT1G Series

BC847B, BC848B, BC849B, BC850B, SBC847B, SBC848B

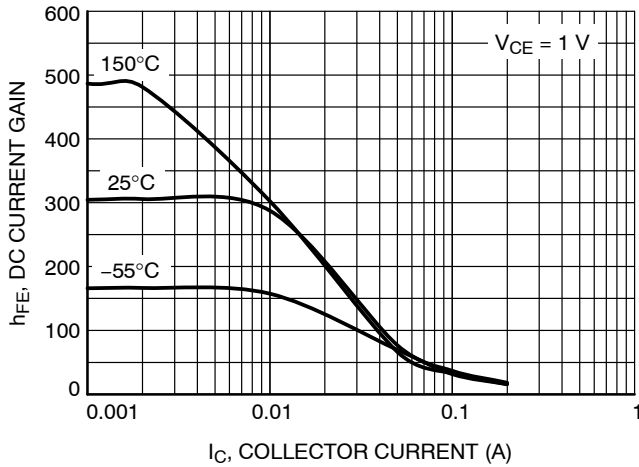

Figure 19. DC Current Gain vs. Collector Current

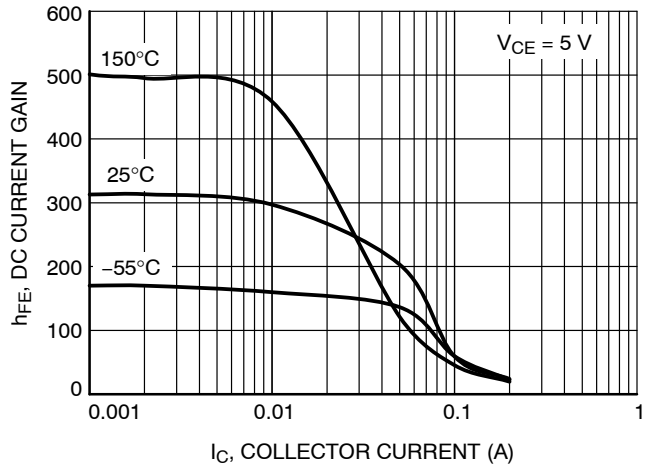

Figure 20. DC Current Gain vs. Collector Current



Figure 21. Collector Emitter Saturation Voltage vs. Collector Current



Figure 22. Base Emitter Saturation Voltage vs. Collector Current



Figure 23. Base Emitter Voltage vs. Collector Current

BC846ALT1G Series

BC847B, BC848B, BC849B, BC850B, SBC846B, SBC847B, SBC848B



Figure 24. Collector Saturation Region



Figure 25. Base-Emitter Temperature Coefficient



Figure 26. Capacitances

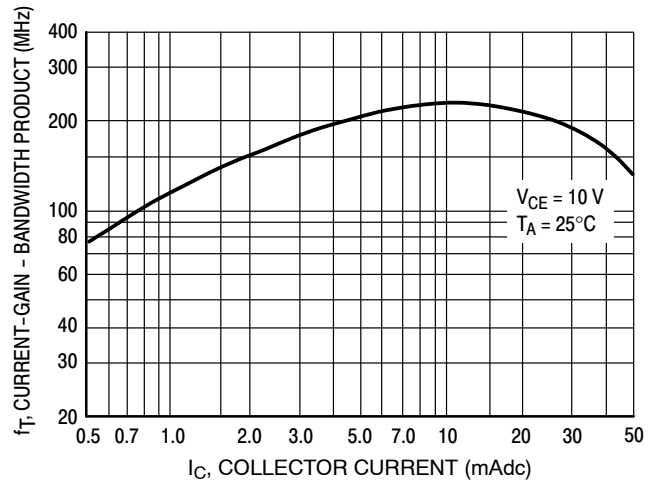

Figure 27. Current-Gain - Bandwidth Product

BC846ALT1G Series

BC846C, BC847C, BC848C, BC849C, BC850C, SBC847C



Figure 28. DC Current Gain vs. Collector Current

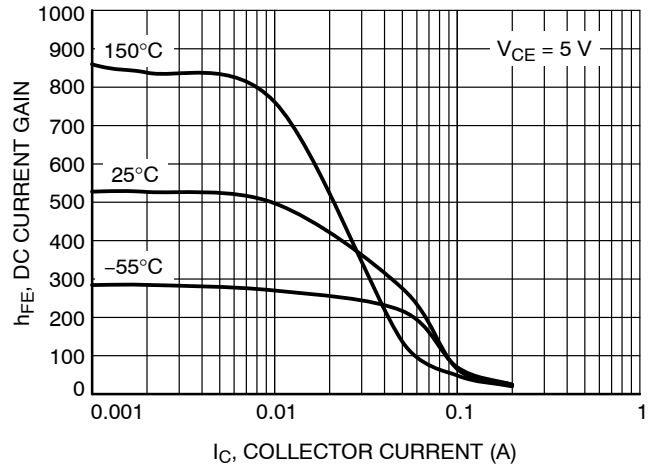

Figure 29. DC Current Gain vs. Collector Current

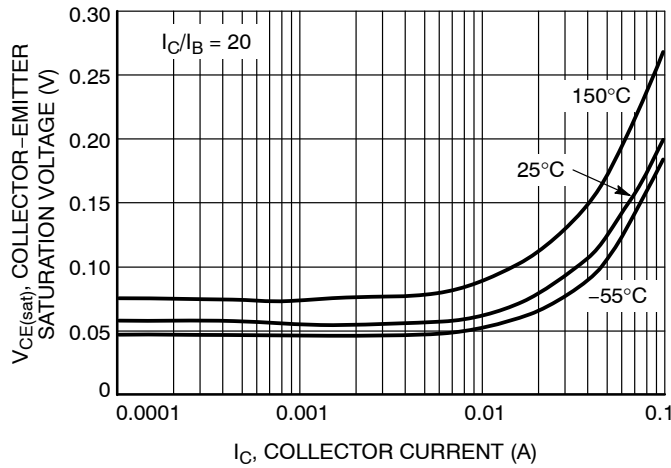

Figure 30. Collector Emitter Saturation Voltage vs. Collector Current



Figure 31. Base Emitter Saturation Voltage vs. Collector Current

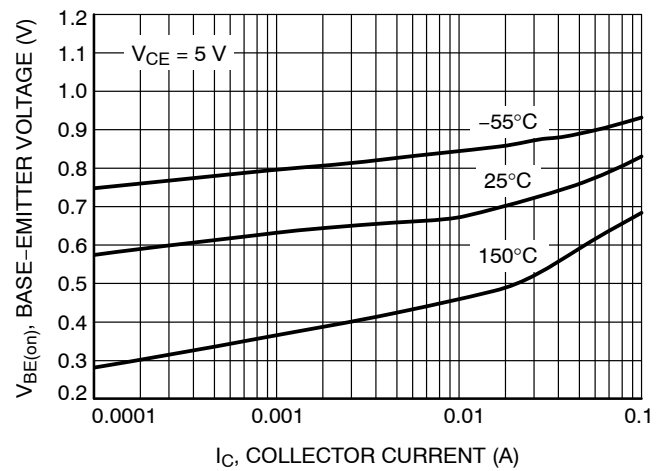

Figure 32. Base Emitter Voltage vs. Collector Current

BC846ALT1G Series

BC846C, BC847C, BC848C, BC849C, BC850C, SBC847C



Figure 33. Collector Saturation Region



Figure 34. Base-Emitter Temperature Coefficient



Figure 35. Capacitances

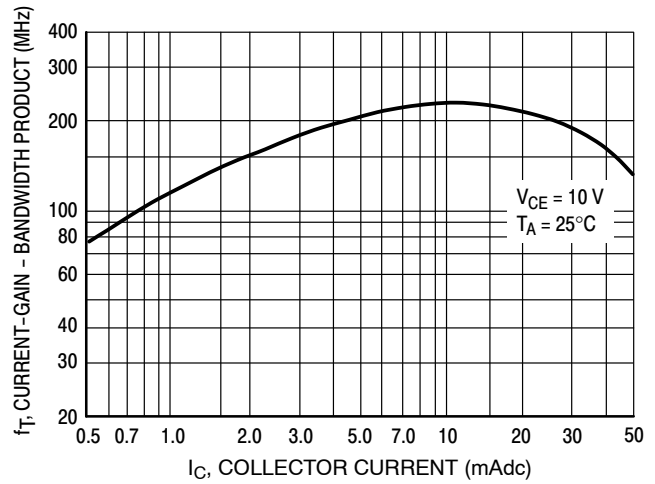

Figure 36. Current-Gain - Bandwidth Product

BC846ALT1G Series

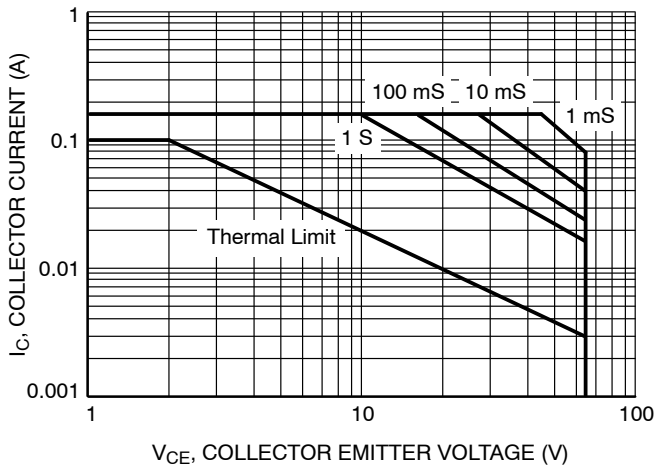

Figure 37. Safe Operating Area for BC846A, BC846B, BC846C

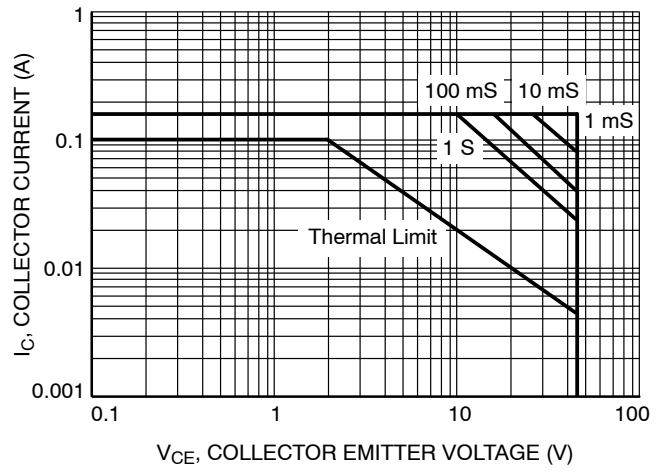

Figure 38. Safe Operating Area for BC847A, BC847B, BC847C, BC850B, BC850C

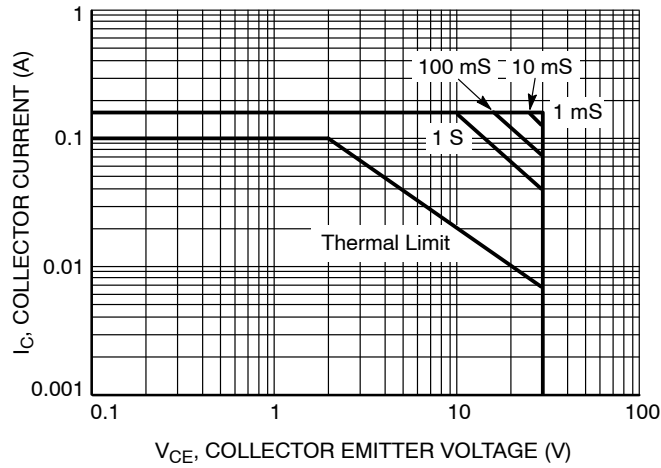

Figure 39. Safe Operating Area for BC848A, BC848B, BC848C, BC849B, BC849C

BC846ALT1G Series

ORDERING INFORMATION

Device	Marking	Package	Shipping [†]
BC846ALT1G	1A	SOT-23 (Pb-Free)	3,000 / Tape & Reel
SBC846ALT1G*			
BC846ALT3G			10,000 / Tape & Reel
BC846BLT1G	1B		3,000 / Tape & Reel
SBC846BLT1G*			
BC846BLT3G			10,000 / Tape & Reel
SBC846BLT3G*			
BC846CLT1G	3C		3,000 / Tape & Reel
BC847ALT1G	1E		3,000 / Tape & Reel
BC847ALT3G			10,000 / Tape & Reel
BC847BLT1G	1F		3,000 / Tape & Reel
SBC847BLT1G*			
BC847BLT3G			
NSVBC847BLT3G*			10,000 / Tape & Reel
BC847CLT1G	1G		3,000 / Tape & Reel
SBC847CLT1G*			
BC847CLT3G			10,000 / Tape & Reel
BC848ALT1G	1J		3,000 / Tape & Reel
BC848BLT1G	1K		3,000 / Tape & Reel
SBC848BLT1G*			
BC848BLT3G			10,000 / Tape & Reel
BC848CLT1G	1L		3,000 / Tape & Reel
NSVBC848CLT1G*			
BC848CLT3G			10,000 / Tape & Reel
BC849BLT1G	2B		3,000 / Tape & Reel
NSVBC849BLT1G*			
BC849BLT3G			10,000 / Tape & Reel
BC849CLT1G	2C		3,000 / Tape & Reel
BC849CLT3G			10,000 / Tape & Reel
BC850BLT1G	2F		3,000 / Tape & Reel
NSVBC850BLT1G*			
BC850CLT1G	2G		
NSVBC850CLT1G*			

[†]For information on tape and reel specifications, including part orientation and tape sizes, please refer to our Tape and Reel Packaging Specifications Brochure, BRD8011/D.

*S and NSV Prefix for Automotive and Other Applications Requiring Unique Site and Control Change Requirements; AEC-Q101 Qualified and PPAP Capable.

MECHANICAL CASE OUTLINE PACKAGE DIMENSIONS



SOT-23 (TO-236)
CASE 318
ISSUE AT

DATE 01 MAR 2023

SCALE 4:1



NOTES:

1. DIMENSIONING AND TOLERANCING PER ASME Y14.5M,1994.
2. CONTROLLING DIMENSION: MILLIMETERS
3. MAXIMUM LEAD THICKNESS INCLUDES LEAD FINISH. MINIMUM LEAD THICKNESS IS THE MINIMUM THICKNESS OF THE BASE MATERIAL.
4. DIMENSIONS D AND E DO NOT INCLUDE MOLD FLASH, PROTRUSIONS, OR GATE BURRS.

DIM	MILLIMETERS			INCHES		
	MIN.	NOM.	MAX.	MIN.	NOM.	MAX.
A	0.89	1.00	1.11	0.035	0.039	0.044
A1	0.01	0.06	0.10	0.000	0.002	0.004
b	0.37	0.44	0.50	0.015	0.017	0.020
c	0.08	0.14	0.20	0.003	0.006	0.008
D	2.80	2.90	3.04	0.110	0.114	0.120
E	1.20	1.30	1.40	0.047	0.051	0.055
e	1.78	1.90	2.04	0.070	0.075	0.080
L	0.30	0.43	0.55	0.012	0.017	0.022
L1	0.35	0.54	0.69	0.014	0.021	0.027
H _E	2.10	2.40	2.64	0.083	0.094	0.104
T	0°	---	10°	0°	---	10°

GENERIC MARKING DIAGRAM*



- XXX = Specific Device Code
- M = Date Code
- = Pb-Free Package

*This information is generic. Please refer to device data sheet for actual part marking. Pb-Free indicator, "G" or microdot "▪", may or may not be present. Some products may not follow the Generic Marking.



RECOMMENDED MOUNTING FOOTPRINT

* For additional information on our Pb-Free strategy and soldering details, please download the ON Semiconductor Soldering and Mounting Techniques Reference Manual, SOLDERRM/D.

STYLES ON PAGE 2

DOCUMENT NUMBER:	98ASB42226B	Electronic versions are uncontrolled except when accessed directly from the Document Repository. Printed versions are uncontrolled except when stamped "CONTROLLED COPY" in red.
DESCRIPTION:	SOT-23 (TO-236)	PAGE 1 OF 2

onsemi and ONSEMI are trademarks of Semiconductor Components Industries, LLC dba onsemi or its subsidiaries in the United States and/or other countries. onsemi reserves the right to make changes without further notice to any products herein. onsemi makes no warranty, representation or guarantee regarding the suitability of its products for any particular purpose, nor does onsemi assume any liability arising out of the application or use of any product or circuit, and specifically disclaims any and all liability, including without limitation special, consequential or incidental damages. onsemi does not convey any license under its patent rights nor the rights of others.

**MECHANICAL CASE OUTLINE
PACKAGE DIMENSIONS**



**SOT-23 (TO-236)
CASE 318
ISSUE AT**

DATE 01 MAR 2023

- STYLE 1 THRU 5:
CANCELLED
- STYLE 6:
PIN 1. BASE
2. EMITTER
3. COLLECTOR
- STYLE 7:
PIN 1. EMITTER
2. BASE
3. COLLECTOR
- STYLE 8:
PIN 1. ANODE
2. NO CONNECTION
3. CATHODE
- STYLE 9:
PIN 1. ANODE
2. ANODE
3. CATHODE
- STYLE 10:
PIN 1. DRAIN
2. SOURCE
3. GATE
- STYLE 11:
PIN 1. ANODE
2. CATHODE
3. CATHODE-ANODE
- STYLE 12:
PIN 1. CATHODE
2. CATHODE
3. ANODE
- STYLE 13:
PIN 1. SOURCE
2. DRAIN
3. GATE
- STYLE 14:
PIN 1. CATHODE
2. GATE
3. ANODE
- STYLE 15:
PIN 1. GATE
2. CATHODE
3. ANODE
- STYLE 16:
PIN 1. ANODE
2. CATHODE
3. CATHODE
- STYLE 17:
PIN 1. NO CONNECTION
2. ANODE
3. CATHODE
- STYLE 18:
PIN 1. NO CONNECTION
2. CATHODE
3. ANODE
- STYLE 19:
PIN 1. CATHODE
2. ANODE
3. CATHODE-ANODE
- STYLE 20:
PIN 1. CATHODE
2. ANODE
3. GATE
- STYLE 21:
PIN 1. GATE
2. SOURCE
3. DRAIN
- STYLE 22:
PIN 1. RETURN
2. OUTPUT
3. INPUT
- STYLE 23:
PIN 1. ANODE
2. ANODE
3. CATHODE
- STYLE 24:
PIN 1. GATE
2. DRAIN
3. SOURCE
- STYLE 25:
PIN 1. ANODE
2. CATHODE
3. GATE
- STYLE 26:
PIN 1. CATHODE
2. ANODE
3. NO CONNECTION
- STYLE 27:
PIN 1. CATHODE
2. CATHODE
3. CATHODE
- STYLE 28:
PIN 1. ANODE
2. ANODE
3. ANODE

DOCUMENT NUMBER:	98ASB42226B	Electronic versions are uncontrolled except when accessed directly from the Document Repository. Printed versions are uncontrolled except when stamped "CONTROLLED COPY" in red.
DESCRIPTION:	SOT-23 (TO-236)	PAGE 2 OF 2

onsemi and **ONSEMI** are trademarks of Semiconductor Components Industries, LLC dba **onsemi** or its subsidiaries in the United States and/or other countries. **onsemi** reserves the right to make changes without further notice to any products herein. **onsemi** makes no warranty, representation or guarantee regarding the suitability of its products for any particular purpose, nor does **onsemi** assume any liability arising out of the application or use of any product or circuit, and specifically disclaims any and all liability, including without limitation special, consequential or incidental damages. **onsemi** does not convey any license under its patent rights nor the rights of others.

onsemi, **Onsemi**, and other names, marks, and brands are registered and/or common law trademarks of Semiconductor Components Industries, LLC dba "**onsemi**" or its affiliates and/or subsidiaries in the United States and/or other countries. **onsemi** owns the rights to a number of patents, trademarks, copyrights, trade secrets, and other intellectual property. A listing of **onsemi**'s product/patent coverage may be accessed at www.onsemi.com/site/pdf/Patent-Marking.pdf. **onsemi** reserves the right to make changes at any time to any products or information herein, without notice. The information herein is provided "as-is" and **onsemi** makes no warranty, representation or guarantee regarding the accuracy of the information, product features, availability, functionality, or suitability of its products for any particular purpose, nor does **onsemi** assume any liability arising out of the application or use of any product or circuit, and specifically disclaims any and all liability, including without limitation special, consequential or incidental damages. Buyer is responsible for its products and applications using **onsemi** products, including compliance with all laws, regulations and safety requirements or standards, regardless of any support or applications information provided by **onsemi**. "Typical" parameters which may be provided in **onsemi** data sheets and/or specifications can and do vary in different applications and actual performance may vary over time. All operating parameters, including "Typicals" must be validated for each customer application by customer's technical experts. **onsemi** does not convey any license under any of its intellectual property rights nor the rights of others. **onsemi** products are not designed, intended, or authorized for use as a critical component in life support systems or any FDA Class 3 medical devices or medical devices with a same or similar classification in a foreign jurisdiction or any devices intended for implantation in the human body. Should Buyer purchase or use **onsemi** products for any such unintended or unauthorized application, Buyer shall indemnify and hold **onsemi** and its officers, employees, subsidiaries, affiliates, and distributors harmless against all claims, costs, damages, and expenses, and reasonable attorney fees arising out of, directly or indirectly, any claim of personal injury or death associated with such unintended or unauthorized use, even if such claim alleges that **onsemi** was negligent regarding the design or manufacture of the part. **onsemi** is an Equal Opportunity/Affirmative Action Employer. This literature is subject to all applicable copyright laws and is not for resale in any manner.

ADDITIONAL INFORMATION

TECHNICAL PUBLICATIONS:

Technical Library: www.onsemi.com/design/resources/technical-documentation
onsemi Website: www.onsemi.com

ONLINE SUPPORT: www.onsemi.com/support

For additional information, please contact your local Sales Representative at www.onsemi.com/support/sales



单击下面可查看定价，库存，交付和生命周期等信息

[>>ON Semiconductor\(安森美\)](#)