



深圳市奥伦德科技有限公司

ORIENT

样品规格书

Specification sheet

品名(P/N): 光电耦合器 Photocoupler
客户名称(Customer): _____
本厂型号(Mfg P/N): ORPC-817S
日期(Date): _____

深圳市奥伦德科技有限公司
Shenzhen Orient Components Co., Ltd.
深圳市光明新区光明同富裕工业区 3 栋 1 楼
1/F, Block 3, Guang Ming Tong Fuyu Industrial
Park, Guang Ming New District, Shenzhen
Tel: 86-755-29681816
Fax: 86-755-29681200
www.orient-opto.com

审核	制表



● 特点 Features:

- 1: 电流转换比(CTR: 最小. 50%工作条件 IF=5mA, VCE=5V)
Current conversion ratio (Min 50% Working condition IF=5mA, VCE=5V)
- 2: 绝缘电压 : (VISO=5,000Vrms)
Insulation Voltage: (VISO=5,000Vrms)
- 3: 响应时间 (tr: TYP. 4 μ s 工作条件 VCE=2V, IC=2mA, RL=100 Ω)
Response Time (tr: TYP. 4 μ s working condition VCE=2V, IC=2mA, RL=100 Ω)
- 4: CE 认证 (AC/0431008)
CQC 认证 (CQC09001029446)
UL 认证 (E323844)

● 说明 Instructions:

- 1: ORPC-817S 系列光耦合器的组成是 : 由一个 GaAs 的发射管和一个 NPN 的晶体管组成
ORPC-817S photocoupler consist of one piece of GaAs emitter and one piece of NPN transistor
- 2: ORPC-817S 的 BIN 脚宽是 2.54mm
BIN width of ORPC-817S is 2.54mm

● 应用范围 Application range:

- 1. 电脑. computer
- 2. 器具的应用, 测量机. Instrumental application, measurement machine
- 3. 贮存器, 复印机, 自动售货机. Imbursement equipments, duplicating machine, automat
- 4. 家用电器, 如风扇等. Family-use electric equipments, such as fans
- 5. 信号传输系统. Signal transforming systems

● 最大绝对额定值 (常温=25 $^{\circ}$ C)

Max Absolute rated value (Normal Temperature=25 $^{\circ}$ C)

参数 Parameter		符号 Sign	额定值 Rated value	单位 Unit
输入 input	正向电流 Forward Current	IF	50	mA
	反向电压 Reverse Voltage	VR	6	V
	消耗功率 Consume Power	P	70	mW
输出 output	集极与射极电压 Collector and emitter Voltage	VCEO	35	V
	射极与集极电压 Emitter and collector Voltage	VECO	6	
	集极电流 Collector Current	IC	50	mA
	消耗功率 Consume Power	PC	150	mW
总功率消耗 Total Consume Power		Ptot	200	mW
*1 绝缘电压 Insulation Voltage		Viso	5,000	Vrms
最大绝缘电压 Max Insulation Voltage		VIOTM	6,000	V
额定脉冲绝缘电压 Rated Impulse Insulation Voltage		VIORM	630	V
工作温度 Working Temperature		Topr	-30 to + 100	$^{\circ}$ C
存贮温度 Deposit Temperature		Tstg	-55 to + 125	
*2 焊锡温度 Soldering Temperature		Tsol	260	

- *1. 交流测试, 时间 1 分钟, 湿度. =40~60%
AC Test, 1 minute, humidity = 40~60%
如下是绝缘测试的方法.
Insulation test method as below:



- (1) 将产品的两端短路。
Short circuit both terminals of photocoupler
- (2) 测试绝缘电压时无电流通过。
No Current when testing insulation voltage
- (3) 测试时加正弦波形电压。
Adding sine wave voltage when testing

*2. 锡焊时间为 10 秒

soldering time is 10 seconds

● 光电特性(常温=25°C)

Opto-electronic characteristics (Normal Temperature=25°C)

参数 Parameter		符号 sign	条件 Condition	最小 Min	中 Midium	最大 Max	单位 Unit
输入 input	顺向电压 Forward Current	VF	IF=20mA	---	1.2	1.4	V
	逆向电流 Reverse Voltage	IR	VR=4V	---	---	10	μA
	集极电容 Collector capacitance	Ct	V=0, f=1KHz	---	30	250	pF
输出 output	集极至射极电流 Collector to emitter Current	ICEO	VCE=20V, IF=0	---	---	100	nA
	集极与射极衰减电压 Collector and Emitter attenuation Voltage	BVCEO	IC=0.1mA, IF=0	35	---	---	V
	射极与集极衰减电压 Emitter and Collector attenuation Voltage	BVECO	IE=10μA, IF=0	6	---	---	V
传输特性 Transforming Characteristics	集极电流 Collector Current	Ic	IF=5mA	2.5	---	30	mA
	*1 电流转换比 Current conversion ratio	CTR	VCE=5V	50	---	600	%
	集极与射极饱和电压 Collector and Emitter Saturation Voltage	VCE(sat)	IF=20mA, IC=1mA	---	0.1	0.2	V
	绝缘阻抗 Insulation Impedance	Riso	DC500V, 40~60%R.H.	5×10 ¹⁰	1×10 ¹¹	---	Ω
	电容量 capacitance	Cf	V=0, f=1MHz	---	0.6	1	pF
	转换频率 Transforming Frequency	fc	VCE=5V, IC=2mA, RL=100Ω, -3dB	---	80	---	kHz
	上升时间 Risetime	tr	VCE=2V, IC=2mA	---	4	18	μs
	下降时间 Descend Time	tf	RL=100Ω	---	3	18	μs



*1 电流转换比= IC / IF × 100%

Current conversion Ratio=IC/IF*100%

● 电流转换比的等级分类 Grades of Current Conversion Ratio

等级标示 Grade sign	最小. (%) Min.	最大. (%) Max.
L	50	100
A	80	160
B	130	260
C	200	400
D	300	600
L or A or B or C or D	50	600

说明：工作条件：IF=5mA, VCE=5V, Ta=25°C.

Note: Working condition: IF=5mA, VCE=5V, Ta=25°C.

● 外形尺寸

Form size

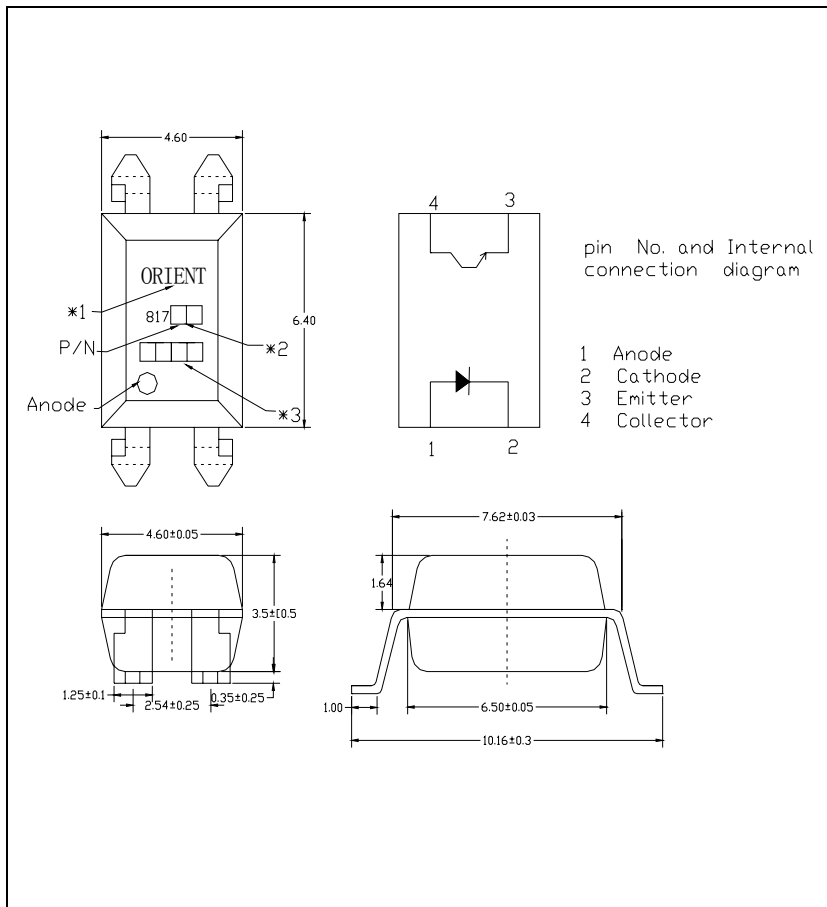

● 注解 Note :

- *1. 公司英文名. Company name
- *2. BIN 级 BIN
- *3. 生产周期. Production period



● 特性曲线 Characteristics Curve

Fig.1 Forward Current vs. Ambient Temperature

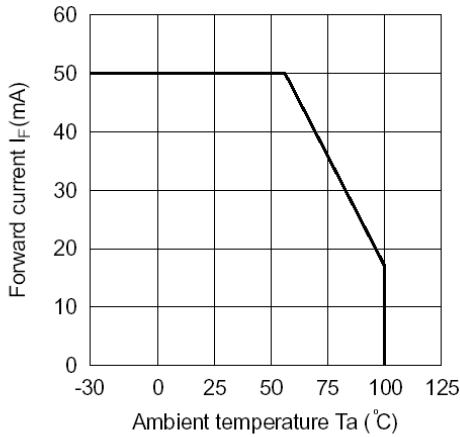

Fig.2 Collector Power Dissipation vs. Ambient Temperature

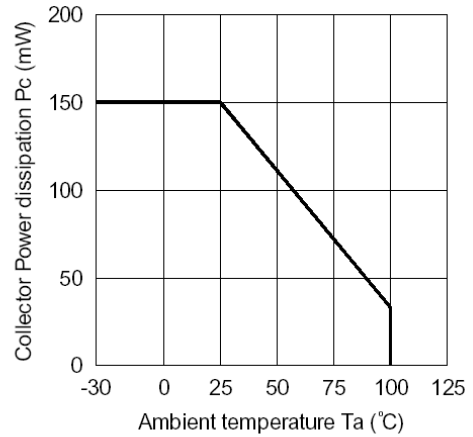

Fig.3 Collector-emitter Saturation Voltage vs. Forward Current

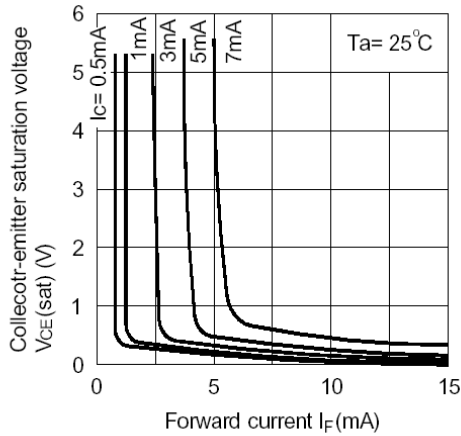

Fig.4 Forward Current vs. Forward Voltage

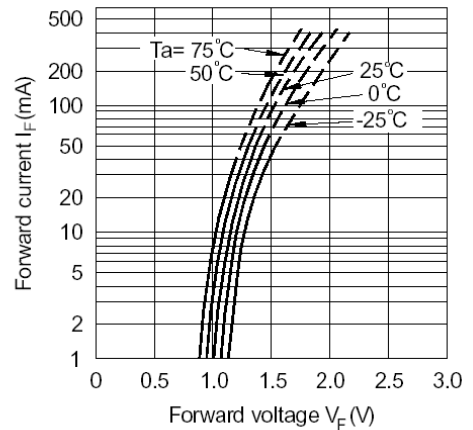

Fig.5 Current Transfer Ratio vs. Forward Current

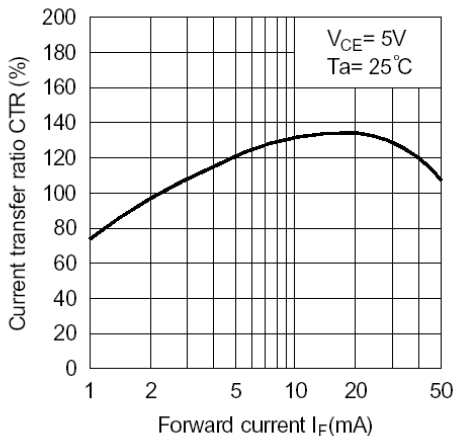
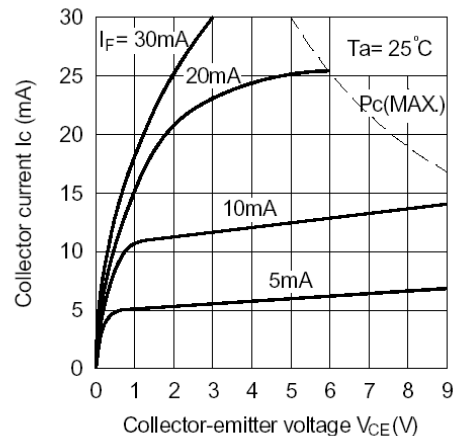

Fig.6 Collector Current vs. Collector-emitter Voltage





● 特性曲线 Characteristics Curve

Fig.7 Relative Current Transfer Ratio vs. Ambient Temperature

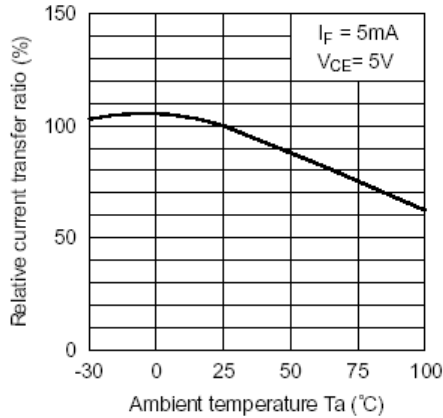

Fig.8 Collector-emitter Saturation Voltage vs. Ambient Temperature

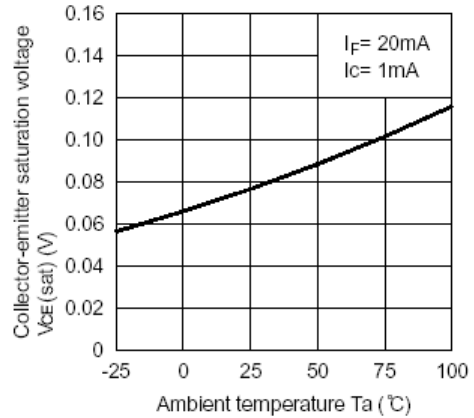

Fig.9 Collector Dark Current vs. Ambient Temperature

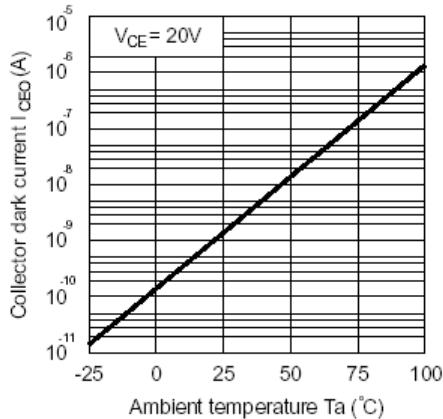

Fig.10 Response Time vs. Load Resistance

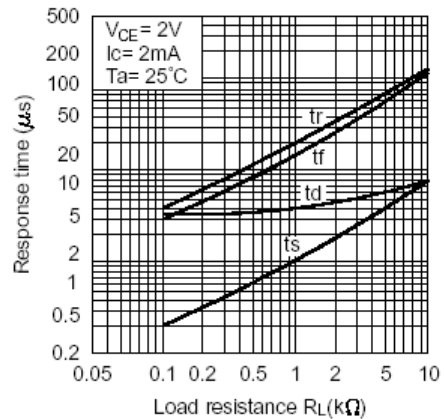
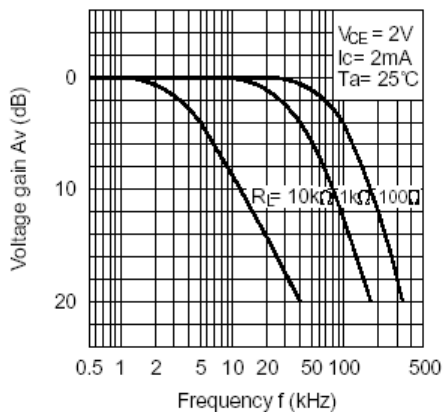
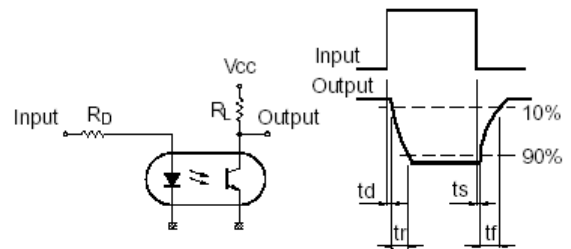

Fig.11 Frequency Response



Test Circuit for Response Time



Test Circuit for Frequency Response

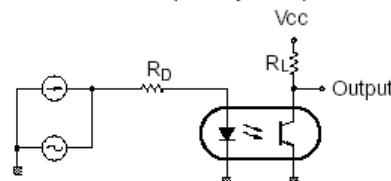



深圳市奥伦德科技有限公司

ORIENT

ORPC-817S

● BVECO	IE=10 μ A, IF=0	Over Lx1.0
---------	---------------------	------------

单击下面可查看定价，库存，交付和生命周期等信息

[>>ORIENT\(奥伦德\)](#)