



ORIENT

Photo coupler

Product Data Sheet

Part Number: OR-263X

Customer: _____

Date: _____

SHENZHEN ORIENT COMPONENTS CO., LTD

Block A 3rd Floor No.4 Building, Tian'an Cyber Park, Huangge Rd, LongGang Dist, Shenzhen, GD

TEL: 0755-29681816

FAX: 0755-29681200

www.orient-opto.com

1. Features

- (1) High speed: 10Mbit/s
- (2) 3.3V/5V supply voltage
- (3) 10kV/μs min. common mode transient immunity (OR-2631) 5kV/μs min. common mode transient immunity (OR-2630)
- (4) Logic gate output
- (5) Guaranteed performance from -40 to 100°C
- (6) High isolation voltage between input and output (Viso=5000 Vrms)
- (7) Safety approval
 - UL approved (No.E323844)
 - VDE approved (No.40029733)
 - CQC approved (No.CQC19001231254)
- (8) In compliance with RoHS, REACH standards
- (9) MSL Class I

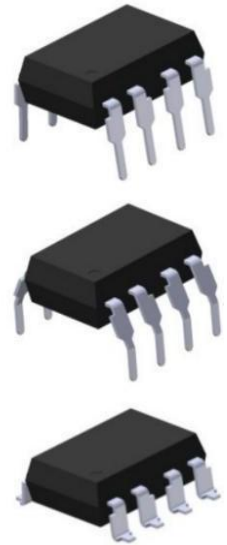

2. Instructions

The OR-2630 and OR-2631 are consists of an infrared emitting diode optically coupled to a high speed integrated photo detector logic gate with a strobable output. It is packaged in a 8-pin DIP package and available in wide-lead spacing and SMD options.

3. Application Range

- (1) Ground loop elimination
- (2) LSTTL to TTL, LSTTL or 5 volt CMOS
- (3) Line receiver, data transmission
- (4) Data multiplexing
- (5) Switching power supplies
- (6) Pulse transformer replacement
- (7) Computer peripheral interface
- (8) High speed logic ground isolation

4. Functional Diagram

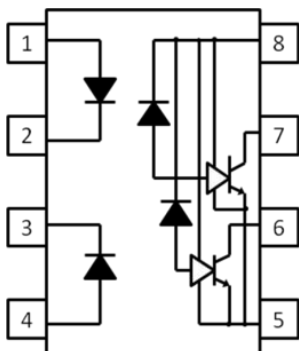

Pin Configuration:

- 1. Anode 5. Gnd
- 2. Cathode 6. Vout2
- 3. Cathode 7. Vout1
- 4. Anode 8. Vcc

Truth Table (Positive Logic)	
Input	Output
H	L
L	H

0.1 capacitor F bypass capacitance needs to be connected between A Pin8 and Pin5

5. Absolute Maximum Ratings (Ta=25°C)*¹

Parameter		Symbol	Rated Value	Unit
Input	Average Forward Input Current	I _F	20	mA
	Reverse Input Voltage	V _R	5	V
	Power Dissipation	P _D	40	mW
Output	Power dissipation	P _C	60	mW
	Output Collector Current	I _O	50	mA
	Output Collector Voltage	V _O	7	V
	Supply voltage	V _{CC}	7	V
Output Power Dissipation		P _O	85	mW
Insulation Voltage		V _{iso}	5000	V _{rms}
Working Temperature		T _{opr}	-40 ~ +100	°C
Storage Temperature		T _{stg}	-55 ~ +125	
Soldering Temperature		T _{sol}	260	

Notes:

*1 AC for 1 minute, R.H.= 40 ~ 60% R.H. In this test, pins 1, 2, 3 & 4 are shorted together, and pins 5, 6, 7 & 8 are shorted together.

*2. soldering time is 10 seconds.

6. Opto-electronic Characteristics

(Unless otherwise specified, $T_a = -40$ to 100°C , $V_{CC} = 2.7$ to 5.5 V)

Parameter		Symbol	Min	Typ	Max	Unit	Condition
Input	Forward Voltage	V_F	—	1.4	1.8	V	$I_F = 10\text{mA}, T_A = 25^\circ\text{C}$
	Temperature Coefficient Of Forward Voltage	$\Delta V_F / \Delta T_A$	—	-1.8	—	mV/ $^\circ\text{C}$	$I_F = 10\text{mA}$
	Reverse Voltage	BV_R	5	—	—	V	$I_R = 10\mu\text{A}$
	Input Capacitance	C_{IN}	—	34	—	pF	$f = 1\text{MHz}, V_F = 0\text{V}$
Output	High Level Supply Current	I_{CCH}	—	12.5	18	mA	$V_{CC} = 5.5\text{V}, I_F = 0\text{mA}$
	Low Level Supply Current	I_{CCL}	—	14.5	21	mA	$V_{CC} = 3.3\text{V}, I_F = 10\text{mA}$
Transfer Characteristics ($T_A = -40$ to $+85^\circ\text{C}$ unless specified otherwise)	High Level Output Current	I_{OH}	—	5	100	μA	$V_{CC} = 5.5\text{V}, V_O = 5.5\text{V}, I_F = 250\mu\text{A}$
	Low Level Output Voltage	V_{OL}	—	0.35	0.6	V	$V_{CC} = 3.3\text{V}, I_F = 5\text{mA}, I_{CL} = 13\text{mA}$
	Input Threshold Current	I_{FT}	—	2.5	5	mA	$V_{CC} = 5.5\text{V}, V_O = 0.6\text{V}, I_{OL} = 13\text{mA}$

7. Switching Characteristics

(Unless otherwise specified, $T_a = -40$ to 100 °C, $V_{CC} = 2.7$ to 3.6 V)

Parameter		Symbol	Min	Typ	Max	Unit	Condition
Propagation delay time to output High level		T_{PLH}	—	32	90	ns	$C_L=15\text{pF}$, $R_L=350\Omega$, $T_A=25^\circ\text{C}$
Propagation delay time to output Low level		T_{PHL}	—	38	90	ns	$C_L=15\text{pF}$, $R_L=350\Omega$, $T_A=25^\circ\text{C}$
Pulse width distortion		$ T_{PHL}-T_{PLH} $	—	5	35	ns	$C_L=15\text{pF}$, $R_L=350\Omega$
Output rise time		t_r	—	40	—	ns	$C_L=15\text{pF}$, $R_L=350\Omega$
Output fall time		t_f	—	10	—	ns	$C_L=15\text{pF}$, $R_L=350\Omega$
Common Mode Transient Immunity at Logic High	OR-2630	CM_H	5	—	—	KV/ μS	$I_F=14\text{mA}$, $V_{O(\text{MIN})}=2\text{V}$, $V_{CM}=1\text{KVp-p}$, $V_{CC}=3.3\text{V}$, $T_A=25^\circ\text{C}$
	OR-2631		10	20	—	KV/ μS	
Common Mode Transient Immunity at Logic Low	OR-2630	CM_L	5	—	—	KV/ μS	$I_F=14\text{mA}$, $V_{O(\text{MAX})}=0.4\text{V}$, $V_{CM}=1\text{KVp-p}$, $V_{CC}=3.3\text{V}$, $T_A=25^\circ\text{C}$
	OR-2631		10	20	—	KV/ μS	

8. Switching Characteristics

(Unless otherwise specified, $T_a = -40$ to 100°C , $V_{CC} = 4.5$ to 5.5 V)

Parameter		Symbol	Min	Typ	Max	Unit	Condition
Propagation delay time to output High level		T_{PLH}	—	35	100	ns	$C_L=15\text{pF}$, $R_L=350\Omega$, $T_A=25^\circ\text{C}$
Propagation delay time to output Low level		T_{PHL}	—	40	100	ns	$C_L=15\text{pF}$, $R_L=350\Omega$, $T_A=25^\circ\text{C}$
Pulse width distortion		$ T_{PHL}-T_{PLH} $	—	8	35	ns	$C_L=15\text{pF}$, $R_L=350\Omega$
Output rise time		t_r	—	40	—	ns	$C_L=15\text{pF}$, $R_L=350\Omega$
Output fall time		t_f	—	10	—	ns	$C_L=15\text{pF}$, $R_L=350\Omega$
Common Mode Transient Immunity at Logic High	OR-2630	CM_H	5	—	—	KV/ μS	$I_F=14\text{mA}$, $V_{O(\text{MIN})}=4\text{V}$, $V_{CM}=1\text{KVp-p}$, $V_{CC}=5\text{V}$, $T_A=25^\circ\text{C}$
	OR-2631		10	20	—	KV/ μS	
Common Mode Transient Immunity at Logic Low	OR-2630	CM_L	5	—	—	KV/ μS	$I_F=14\text{mA}$, $V_{O(\text{MAX})}=0.4\text{V}$, $V_{CM}=1\text{KVp-p}$, $V_{CC}=5\text{V}$, $T_A=25^\circ\text{C}$
	OR-2631		10	20	—	KV/ μS	



9. Order Information

Part Number

OR-263XY-Z

Note

263X = Part Number, 2630 or 2631.

Y = Lead form option (S, M or none)

Z = Tape and reel option (TA,TA1 or none).

Option	Description	Packing quantity
None	Standard SMD Option	45 units per tube
M	Wide lead bend (0.4 inch spacing)	45 units per tube
TA	Surface mount lead form (low profile) + TP tape & reel option	1000 units per reel
TA1	Surface mount lead form (low profile) + TP1 tape & reel option	1000 units per reel

10. Naming Rule

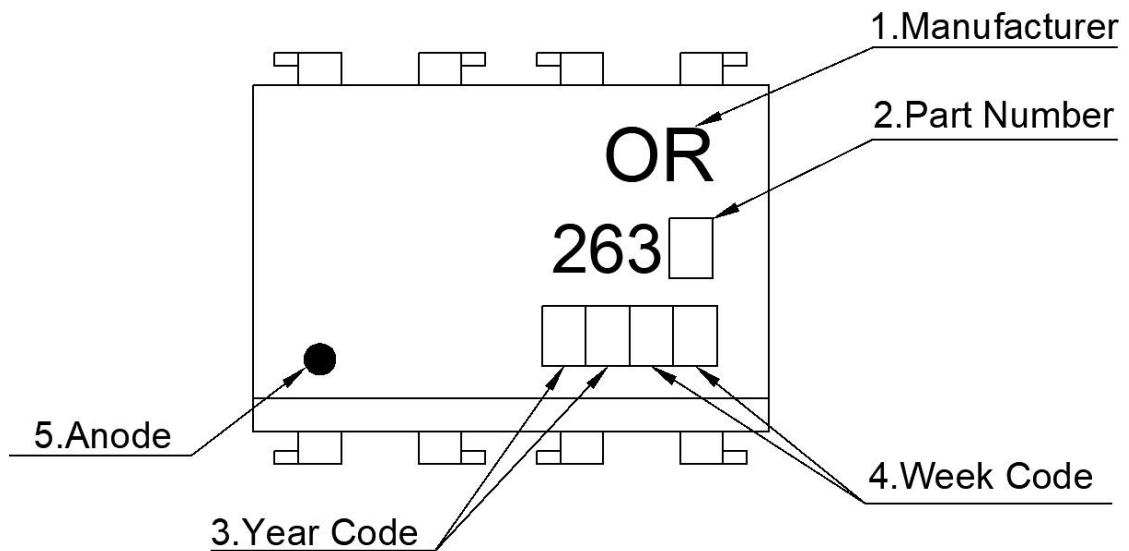

1. Manufacturer : ORIENT.
2. Part Number : 2630 or 2631.
3. Year Code : '21' means '2021' and so on.
4. Week Code : 01 means the first week, 02 means the second week and so on.
5. Anode.

11. Outer Dimension

(1) OR-263X

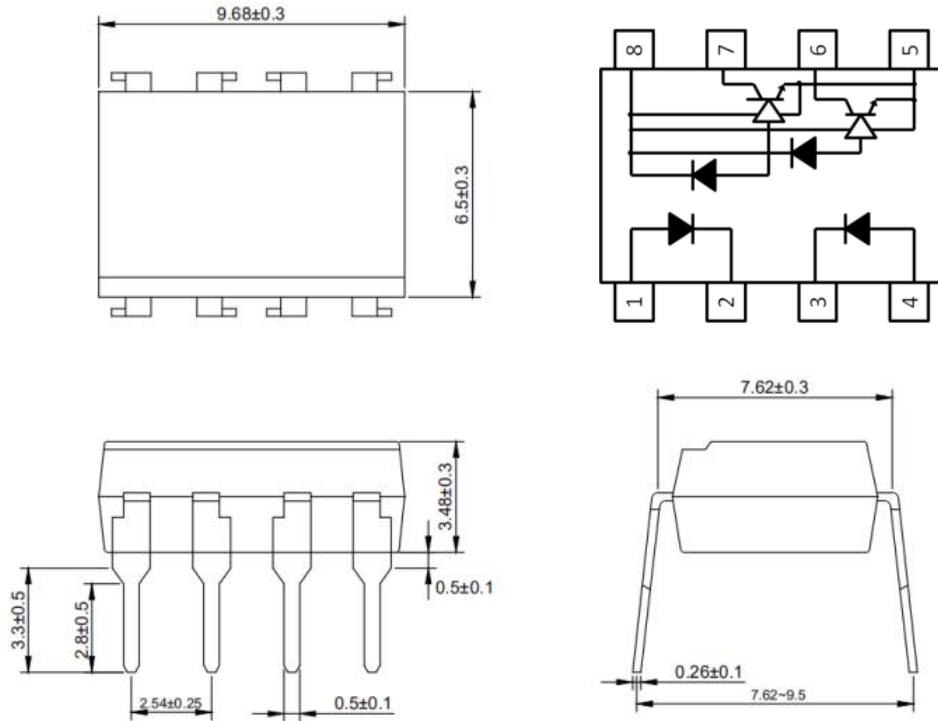

(2) OR-263XM

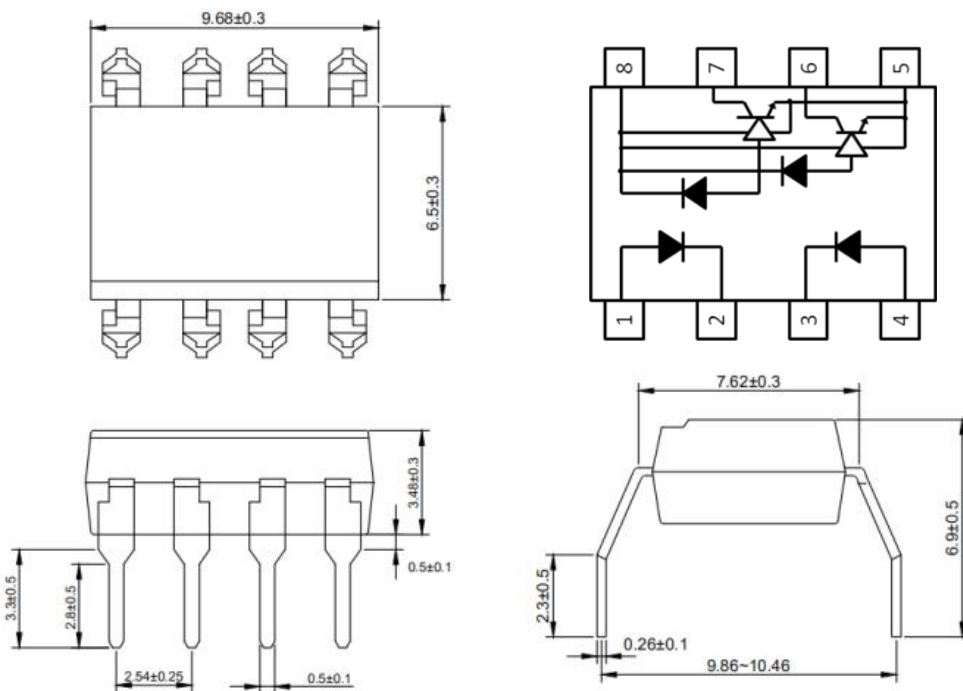

(3) OR-263XS

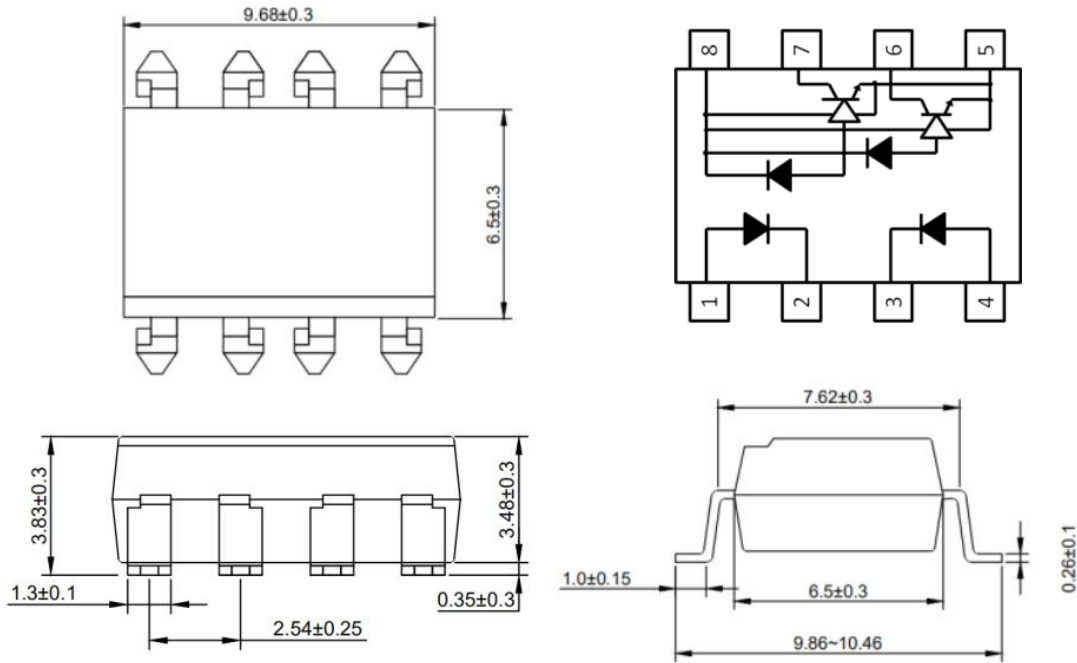

12. Recommended Foot Print Patterns (Mount Pad)

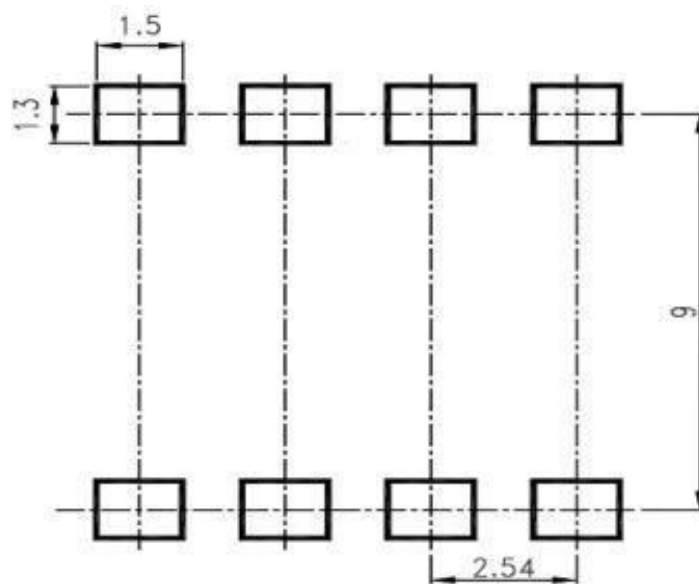

Unit: mm

13. Taping Dimensions

(1) OR-263XS-TA

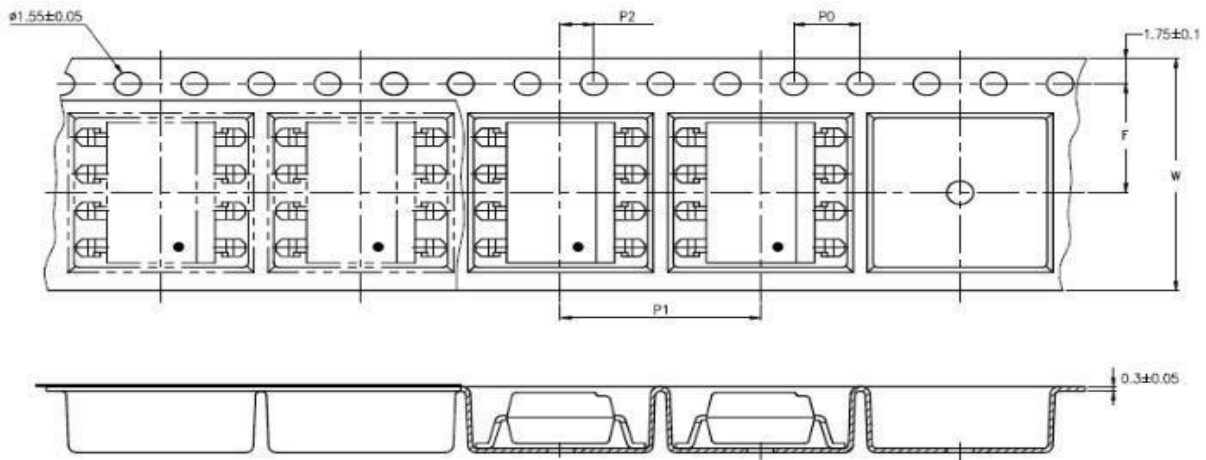

(2) OR-263XS-TA1

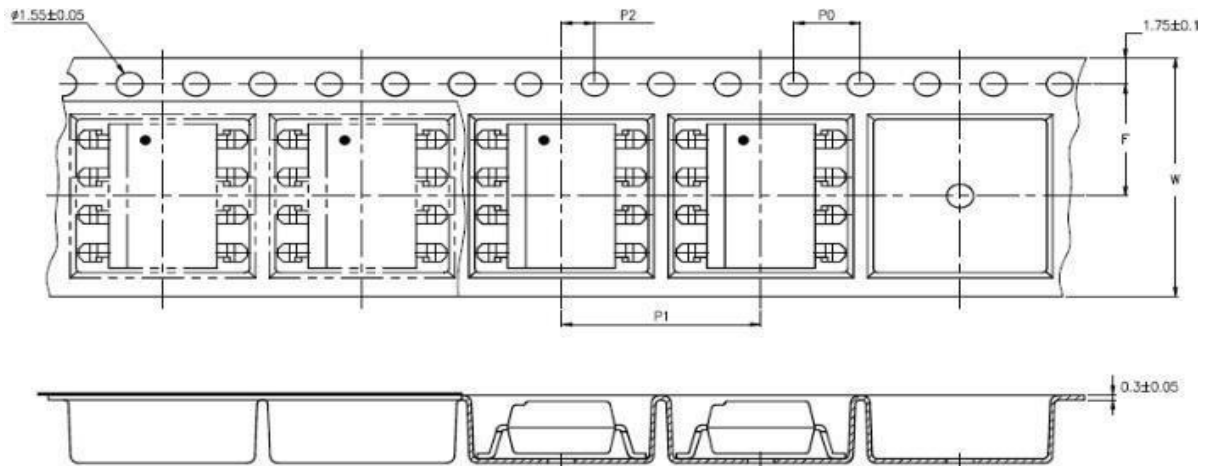

type	symbol	Size: mm (inches)
bandwidth	W	16±0.3 (0.63)
pitch	P0	4±0.1 (0.15)
pitch	F	7.5±0.1 (0.295)
	P2	2±0.1 (0.079)
interval	P1	12±0.1 (0.472)

Encapsulation type	TA/TA1
Amount (pcs)	1000

14. Package Dimension

(1) package dimension

DIP Type

Packing Information	
Packing type	Tube
Qty per Tube	45pcs
Small box (Inner) Dimension	525*128*60mm
Large box (Outer) Dimension	545*290*335mm
The Amount per Inner Box	2,250pcs
The Amount per Outer Box	22,500pcs

SOP Type

Packing Information	
Packing type	Reel type
Tape Width	16mm
Qty per Reel	1,000pcs
Small box (inner) Dimension	345*345*58.5mm
Large box (Outer) Dimension	620x360x360mm
Max qty per small box	2,000pcs
Max qty per large box	20,000pcs

(2)Packing Label Sample



Note:

1. P/N :Contents with "Order Information" in the specification.
2. LOT NO : The production lot.
3. BATCH : The Electrical rank.
4. Quantity :Packaging quantity.
5. Product Data :Date of manufacture.

15. Reliability Test

NO.	ITEMS	Reliability Testing				
		QTY. (Pcs)	Condition	Process	Device	Standard
1	RSH 耐焊接热	22	260±5°C	5s/3 次	锡炉	JESD22-A106
2	HTSL 高温存储	77	125°C	168 hrs	高温烤箱 测试仪	JESD22-A103
				500 hrs		
				1000 hrs		
3	LTSL 低温存储	77	-40°C	168 hrs	低温箱 测试仪	JESD22-A119
				500 hrs		
				1000 hrs		
4	TC 温度循环	77	H:125°C 15min ↓5min L:-55°C 15min	300 cycle	冷热冲击 机	JESD22-A104
5	TS 温度冲击	77	H:100°C 5min ↓15s L:-40°C 5min	300 cycle	冷热冲击 机	JESD22-A106
6	HTOL 高温操作	77	100°C IF=10mA Vcc=5V	168 hrs	高温烤箱 测试仪、 老化电路 板	JESD22-A108
				500 hrs		
				1000 hrs		
7	ESD- HBM 人体模式	22	≥8KV 1Cycle	1次	ESD静电 测试仪	JESD22-A114
8	SD 可焊性	22	Pb-free 245±5°C	5s/1次	锡炉	JESD22-B102
9	HTHB 温湿寿命 试验	77	85°C,85%RH IF=10mA,Vcc=5V	168 hrs	恒温恒湿 机, 测试 仪	JESD22-A101
				500 hrs		
				1000 hrs		
10	Autoclave 压力锅	77	Ta=121 °C,100%RH,2atm	96hrs	压力锅	JESD22-A102

16. Temperature Profile Of Soldering

(1) IR Reflow soldering (JEDEC-STD-020C compliant)

Note: one solder backflow is recommended under the conditions described below in the temperature and time profile. Do not weld more than three times.

Profile item	Conditions
Preheat	
- Temperature Min (T Smin)	150°C
- Temperature Max (T Smax)	200°C
- Time (min to max) (ts)	90±30 sec
Soldering zone	
- Temperature (TL)	217°C
- Time (t L)	60 sec
Peak Temperature	260°C
Peak Temperature time	20 sec
Ramp-up rate	3°C / sec max.
Ramp-down rate from peak temperature	3~6°C / sec
Reflow times	≤3

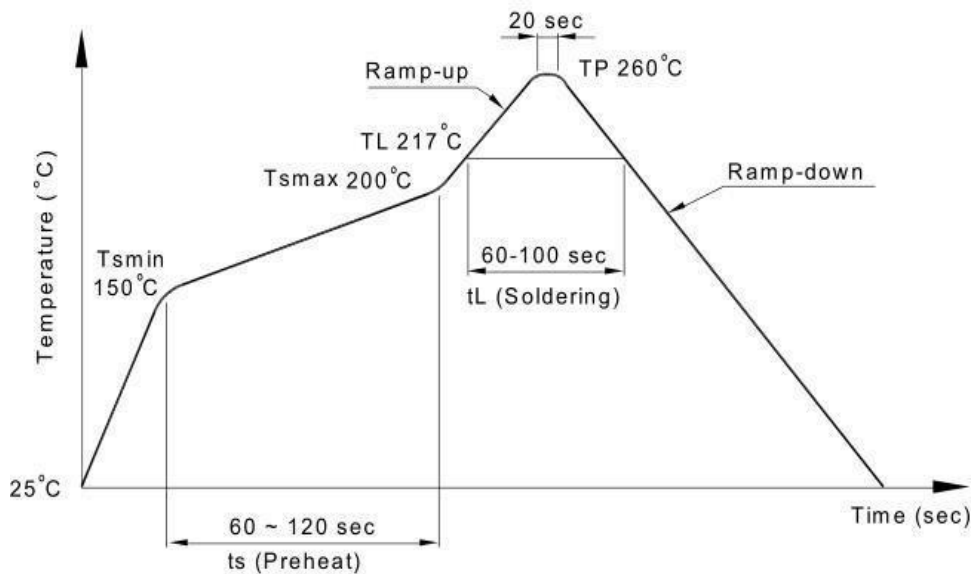

(2) Wave soldering (JEDEC22A111 compliant)

One-time welding is recommended under the temperature condition.

Temperature	260+0/-5°C
Time	10 sec
Preheat temperature	5 to 140°C
Preheat time	30 to 80sec

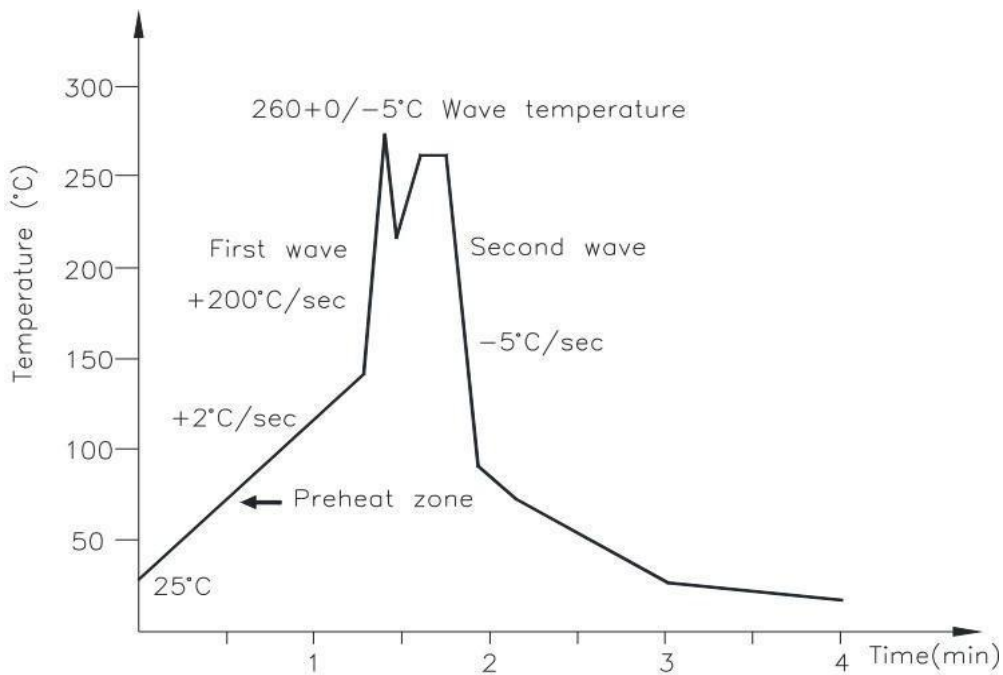

(3) Hand soldering by soldering iron

Single lead welding is allowed in each process and one-time welding is recommended.

Temperature	380+0/-5°C
Time	3 sec max

17. Typical Electro-Optical Characteristics Curves

Figure 1. Forward Current vs Forward Voltage

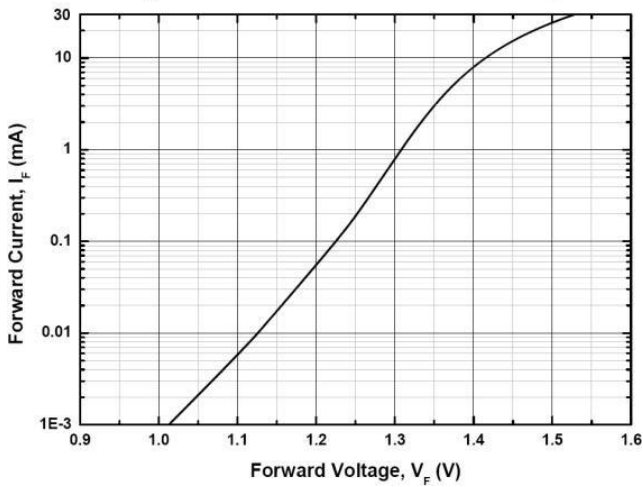

Figure 2. Low Level Output Voltage vs Ambient Temperature

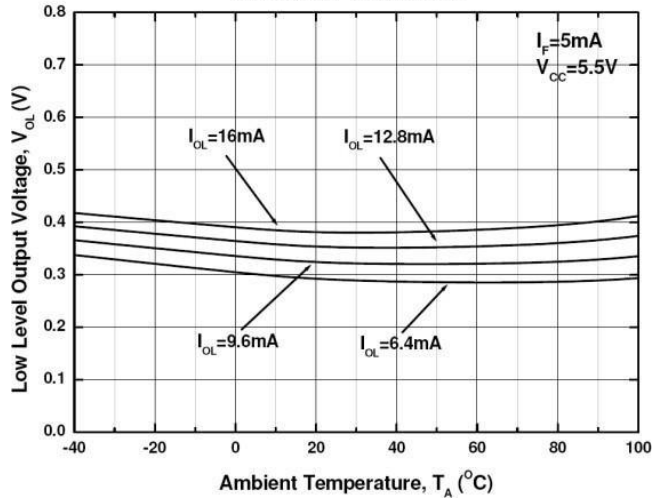

Figure 3. Low Level Output Current vs Ambient Temperature

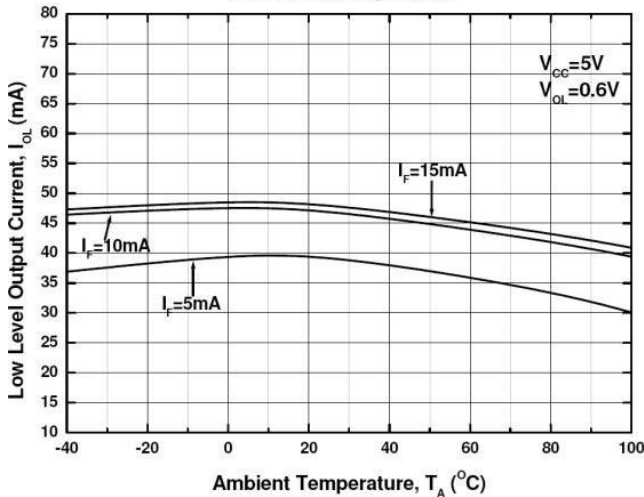

Figure 4. Input Threshold Current vs Ambient Temperature

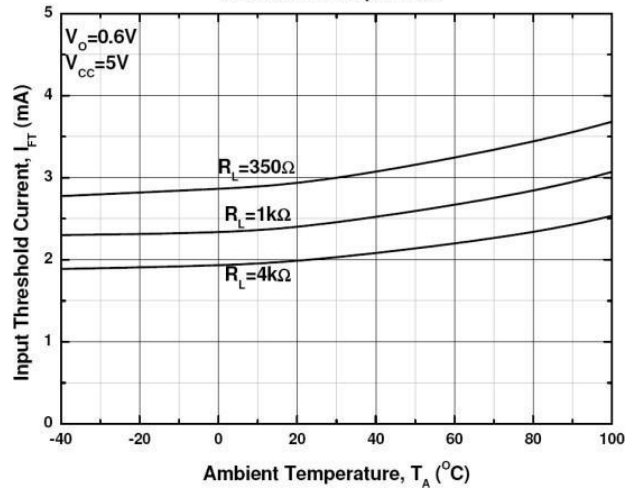

Figure 5. Input Current vs Output Voltage

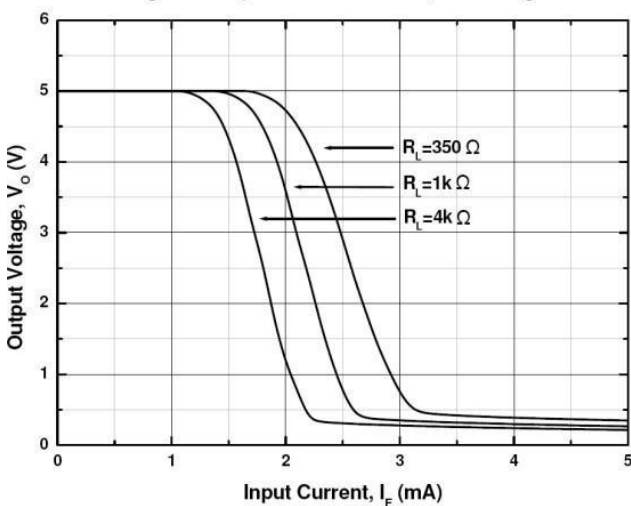

Figure 6. High Level Output Current vs Ambient Temperature

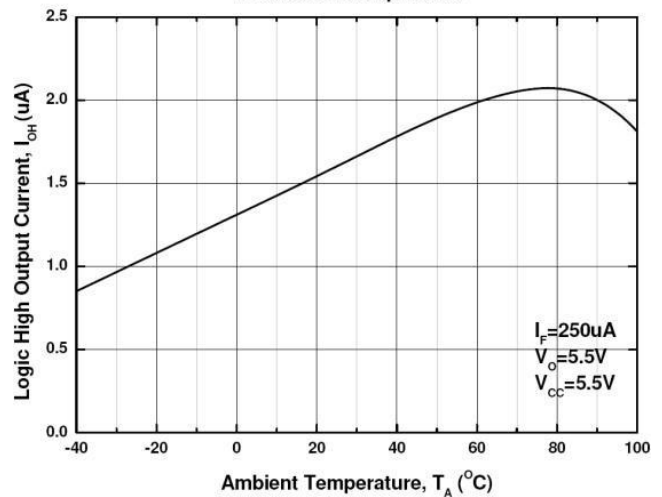

Figure 7. Propagation Delay vs. Forward Current

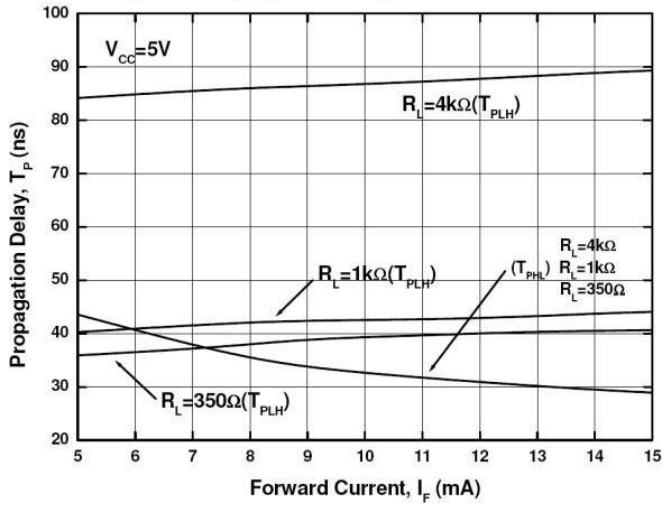

Figure 8. Propagation Delay vs. Temperature

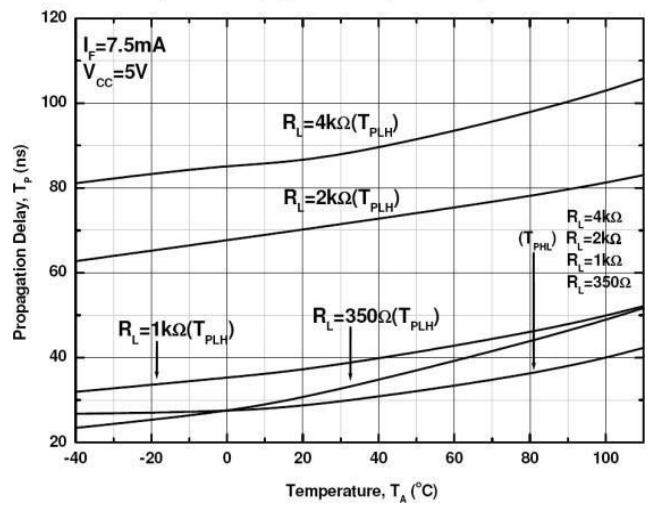

Figure 9. Pulse Width Distortion vs. Temperature

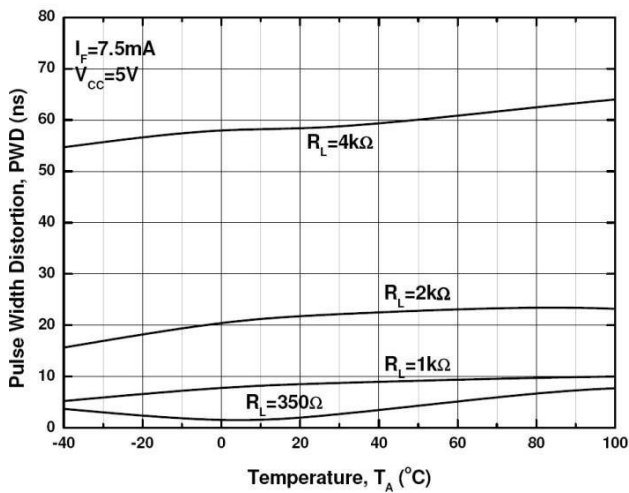

Figure 10. Rise and Fall Time vs. Temperature

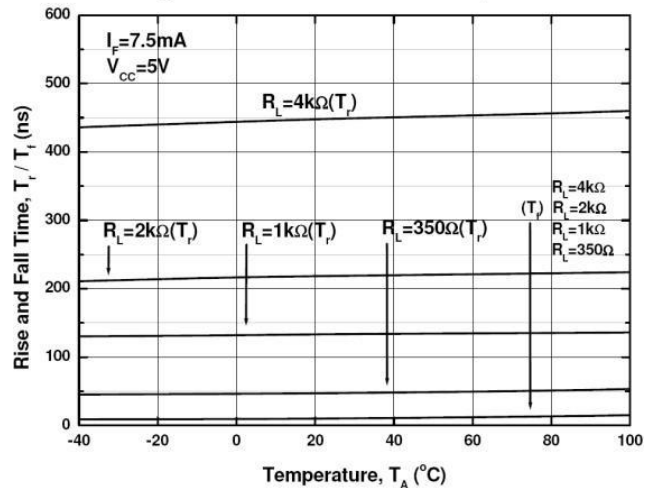

Fig. 11 Test circuit and waveforms for t_{PHL} , t_{PLH} , t_r , and t_f

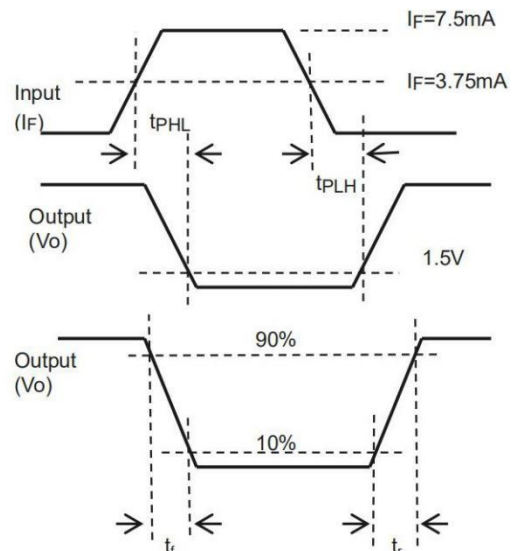
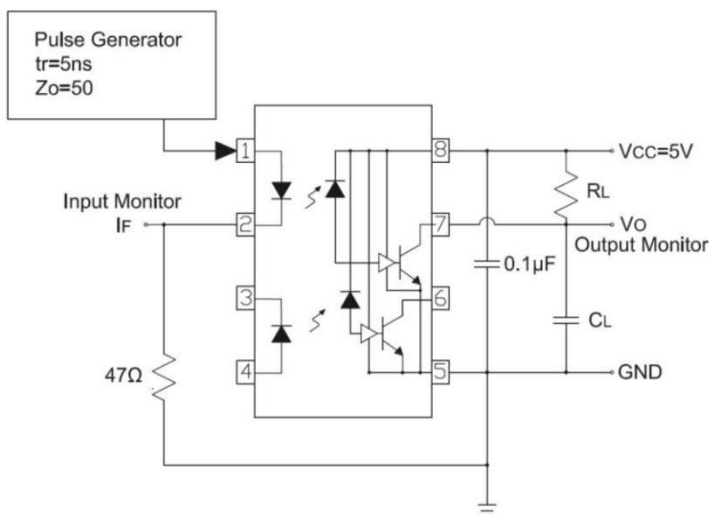
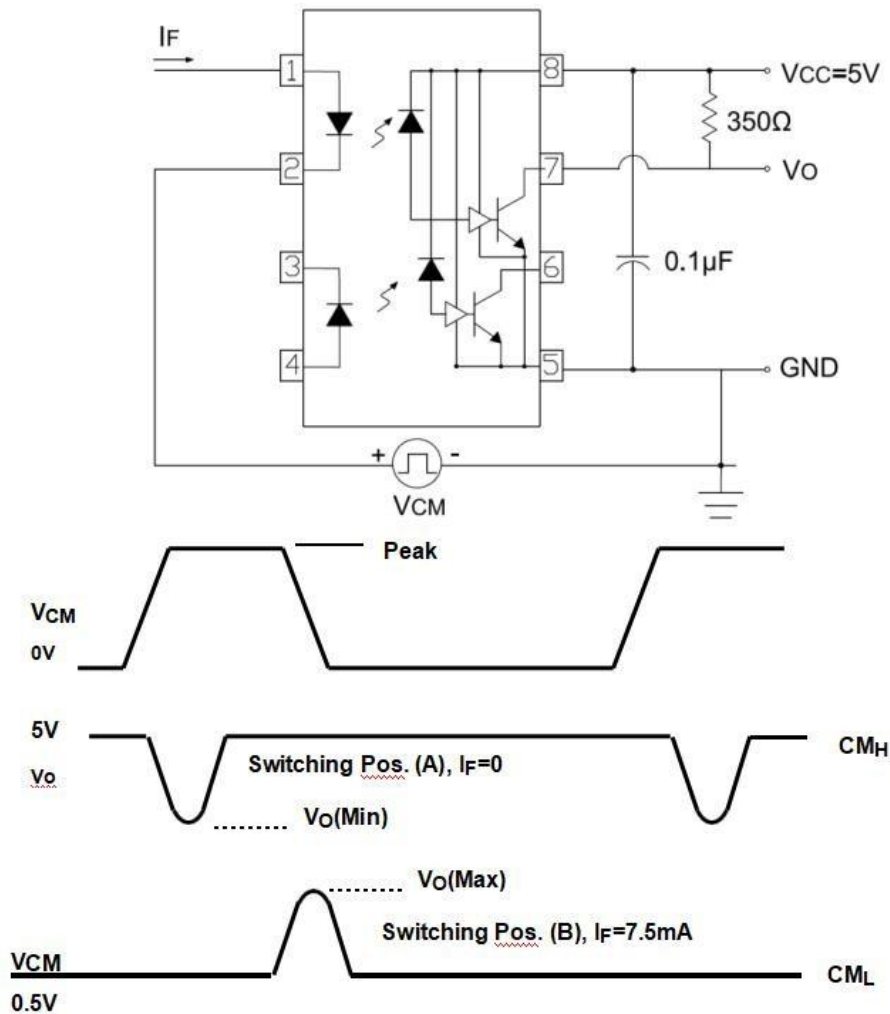

Fig. 12 Test circuit Common mode Transient Immunity



Note

- *3 The VCC supply must be bypassed by a 0.1μF capacitor or larger. This can be either a ceramic or solid tantalum capacitor with good high frequency characteristic and should be connected as close as possible to the package VCC and GND pins
- *4. tPLH– Propagation delay is measured from the 3.75mA level on the HIGH to LOW transition of the input current pulse to the 1.5 V level on the LOW to HIGH transition of the output voltage pulse.
- *5. tPHL– Propagation delay is measured from the 3.75mA level on the LOW to HIGH transition of the input current pulse to the 1.5 V level on the HIGH to LOW transition of the output voltage pulse.
- *6. tr– Rise time is measured from the 90% to the 10% levels on the LOW to HIGH transition of the output pulse.
- *7. tf– Fall time is measured from the 10% to the 90% levels on the HIGH to LOW transition of the output pulse.
- *8 CMH– The maximum tolerable rate of rise of the common mode voltage to ensure the output will remain in the HIGH state (i.e., VOUT > 2.0V).
- *9 CML– The maximum tolerable rate of rise of the common mode voltage to ensure the output will remain in the LOW output state (i.e., VOUT < 0.8).

单击下面可查看定价，库存，交付和生命周期等信息

[>>ORIENT\(奥伦德\)](#)