



ORIENT

Photo coupler

Product Data Sheet

Part Number: OR-MOC304X/306X/308X

Customer: _____

Date: _____

SHENZHEN ORIENT COMPONENTS CO., LTD

Block A 3rd Floor No.4 Building, Tian'an Cyber Park, Huangge Rd, LongGang Dist, Shenzhen, GD

TEL: 0755-29681816

FAX: 0755-29681200

www.orient-opto.com

1. Features

- (1) High isolation voltage between input and output (Viso:5000 V rms)
- (2) 6pin zero-cross optoisolators triac driver output
- (3) High repetitive peak off-state voltage VDRM.
- (4) OR-MOC304X: Min. 400V;OR-MOC306X: Min. 600V;OR-MOC308X: Min. 800V
- (5) High critical rate of rise of off-state voltage(dV/dt : TYP. 800V /s)
- (6) Have Dual-in-line package;Wide lead spacing package and Surface mounting package .
- (7) Operating temperature -40 °C to +110 °C
- (8) Safety approval
 - UL approved (No.E323844)
 - VDE approved(No.40029733)
 - CQC approved (No.CQC19001231480)
- (9) In compliance with RoHS, REACH standards
- (10) MSL Level 1

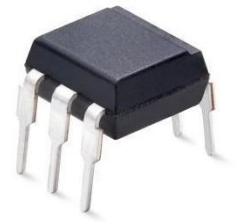

2. Description

The OR-MOC304X/OR-MOC306X/OR-MOC308X series of devices each consist of a GaAs infrared emitting diode optically coupled to a monolithic silicon zero voltage crossing photo triac.They are designed for use with a discrete power triac in the interface of logic systems , such as solid-state relays, industrial controls, motors, solenoids and consumer appliances.

3. Application Range

- (1)AC Motor Drives (2)AC Motor Starters (3)Static power switch (4)Lighting Controls
 (5)Solenoid/Valve Controls (6)Solid State Relays (7)Temperature Controls

4. Absolute Maximum Ratings (Ta=25°C)

Parameter		Symbol	Rateing	Unit	
Input	Forward Current	I _F	50	mA	
	Junction Temperature	T _J	125	°C	
	Reverse Voltage	V _R	6	V	
	Power Dissipation	P	120	mW	
Output	Off-State Output Terminal Voltage	OR-MOC304X	400	V	
		OR-MOC306X	600		
		OR-MOC308X	800		
	Peak Repetitive Surge Current (PW=1ms, 120 pps)		I _{TSM}	1	A
	On-State RMS Current		I _{T(RMS)}	100	mA
	Junction Temperature		T _J	125	°C
	Collector Power Dissipation		P _C	150	mW
Total Power Dissipation		P _{tot}	250	mW	
*Insulation Voltage		V _{iso}	5000	V _{rms}	
Working Temperature		T _{opr}	-40 ~ + 110	°C	
Deposit Temperature		T _{stg}	-55 ~ + 125		
*2 Soldering Temperature		T _{sol}	260		

*1 AC for 1 minute, R.H.= 40 ~ 60% R.H. In this test, pins 1, 2&3 are shorted together, and pins 4, 6 are shorted together.
 * 2 For 10 second

5. Electrical Optical Characteristics at Ta=25°C

Parameter		Symbol	Min	Typ.	Max	Unit	Condition	
Input	Forward Voltage	V_F	---	1.2	1.6	V	$I_F=20mA$	
	Reverse Current	I_R	---	---	5	μA	$V_R=6V$	
Output	1.Peak Blocking Current, Either Direction	I_{DRM}	---	---	500	nA	$V_{DRM} =$ Rated V_{DRM}	
	Peak On-State Voltage, Either Direction	V_{TM}	---	---	3.0	V	$I_{TM}=100mA$ Peak	
	2.Critical rate of Rise of Off-State Voltage	dv/dt	---	800	---	V/ μs	$V_{in}=240V_{rms}$	
Couple	3.Led Trigger Current, Current Required to Latch Output, Either Direction	OR-MOC3040 OR-MOC3060 OR-MOC3080	---	---	30	mA	Main Terminal Voltage = 3V	
		OR-MOC3041 OR-MOC3061 OR-MOC3081	---	---	15			
		OR-MOC3042 OR-MOC3062 OR-MOC3082	---	---	10			
		OR-MOC3043 OR-MOC3063 OR-MOC3083	---	---	5			
		OR-MOC3044 OR-MOC3064 OR-MOC3084	---	---	3			
		I_{FT}	---	---	---			---
		I_{FT}	---	---	---			---
		I_{FT}	---	---	---			---
		I_{FT}	---	---	---			---
		I_{FT}	---	---	---			---
Holding Current, Either Direction		I_H	---	400	---	μA		
ZERO CROSSING	Inhibit Voltage	V_{INH}	---	5	20	Volts	$I_F = \text{Rated } I_{FT}$, MT1-MT2 Voltage above which device will not trigger.	
	Leakage in Inhibited State	I_{DRM2}	---	---	500	μA	$I_F = \text{Rated } I_{FT}$, Rated V_{DRM} , Off State	



- *1. Test voltage must be applied within dv/dt rating.
 *2. This is static dv/dt. Commutating dv/dt is a function of the load-driving thyristor(s) only.
 *3. All devices are guaranteed to trigger at an I_F value less than or equal to $\max I_{FT}$. Therefore, recommended operating I_F lies between $\max I_{FT}$, 30 mA for OR-MOC3040, OR-MOC3060 and OR-MOC3080, 15 mA for OR-MOC3041, OR-MOC3061 and OR-MOC3081, 10 mA for OR-MOC3042, OR-MOC3062 and OR-MOC3082, 5 mA for OR-MOC3043, OR-MOC3063 and OR-MOC3083, 3 mA for OR-MOC3044, OR-MOC3064 and OR-MOC3084, and absolute $\max I_F$ (50mA).

6. Order Information

Part Number

OR-MOC304XV-W-Y
 or **OR-MOC306XV-W-Y**
 or **OR-MOC308XV-W-Y**

Note

- X = IFT Rank (0,1, 2, 3 or 4).
 V = Lead form option (S, M or None).
 W = Tape and reel option (TA,TA1 or none).
 Y = 'V' code for VDE safety (This options is not necessary).

* VDE Code can be selected.

Option	Description	Packing quantity
None	Standard DIP-6	66 units per tube
M	Wide lead bend (0.4 inch spacing)	66 units per tube
S(TA)	Surface mount lead form (low profile) + TA tape & reel option	1000 units per reel
S(TA1)	Surface mount lead form (low profile) + TA1 tape & reel option	1000 units per reel

7. Naming Rule

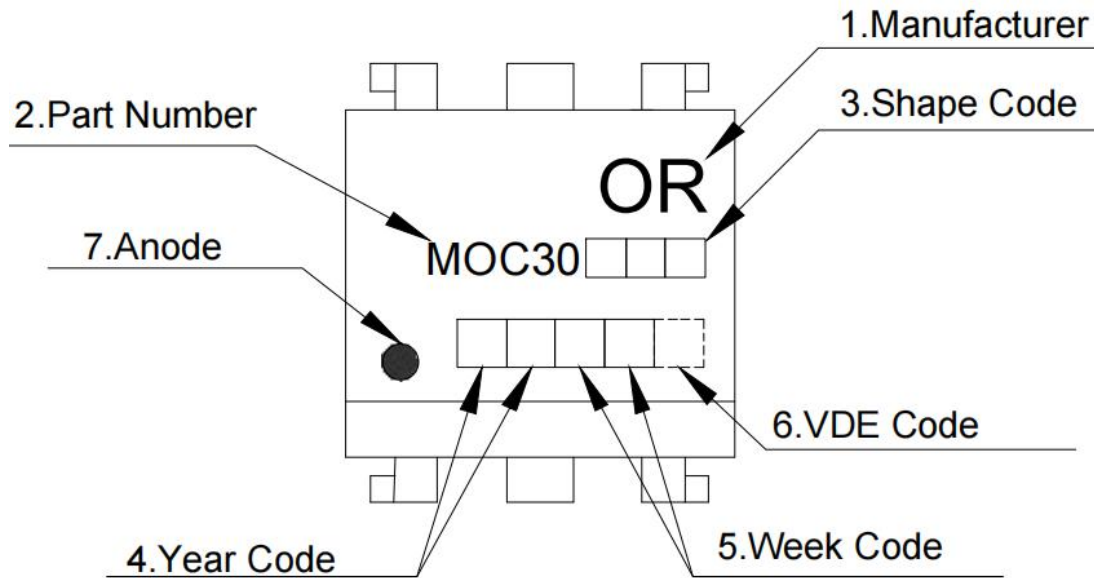

1. Manufacturer : ORIENT.
2. Part Number : MOC30 .
3. Shape Code .
4. Year Code : '21' means '2021' and so on.
5. Week Code : 01 means the first week, 02 means the second week and so on.
6. VDE Code . (Optional)
7. Anode.

* VDE Code can be selected.

8. Package Dimension

(1).MOC30XX

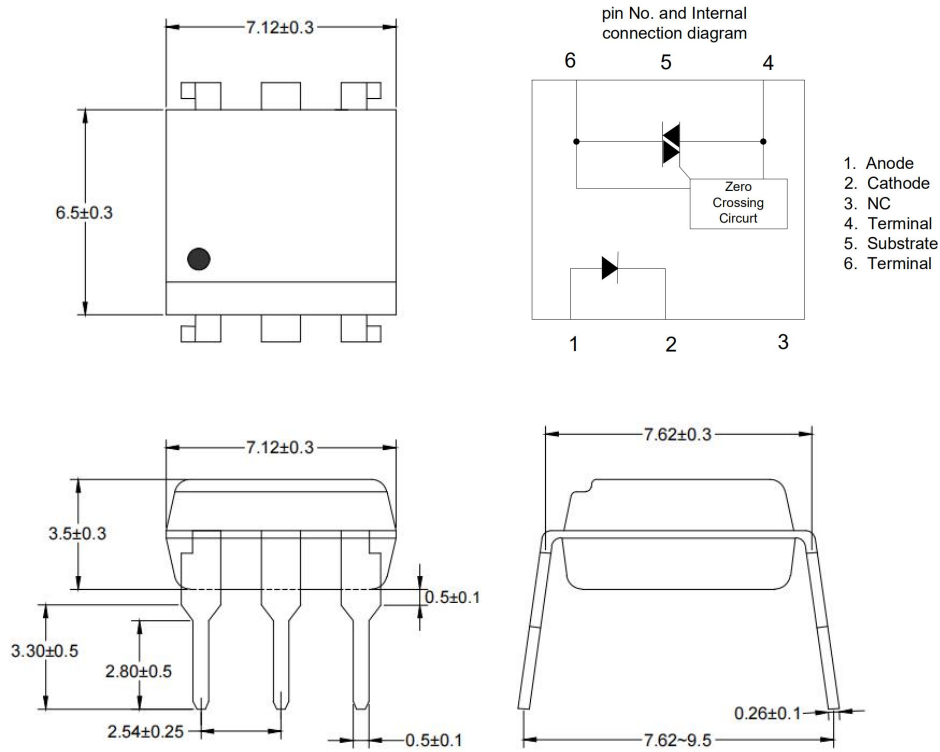

(2).MOC30XX M

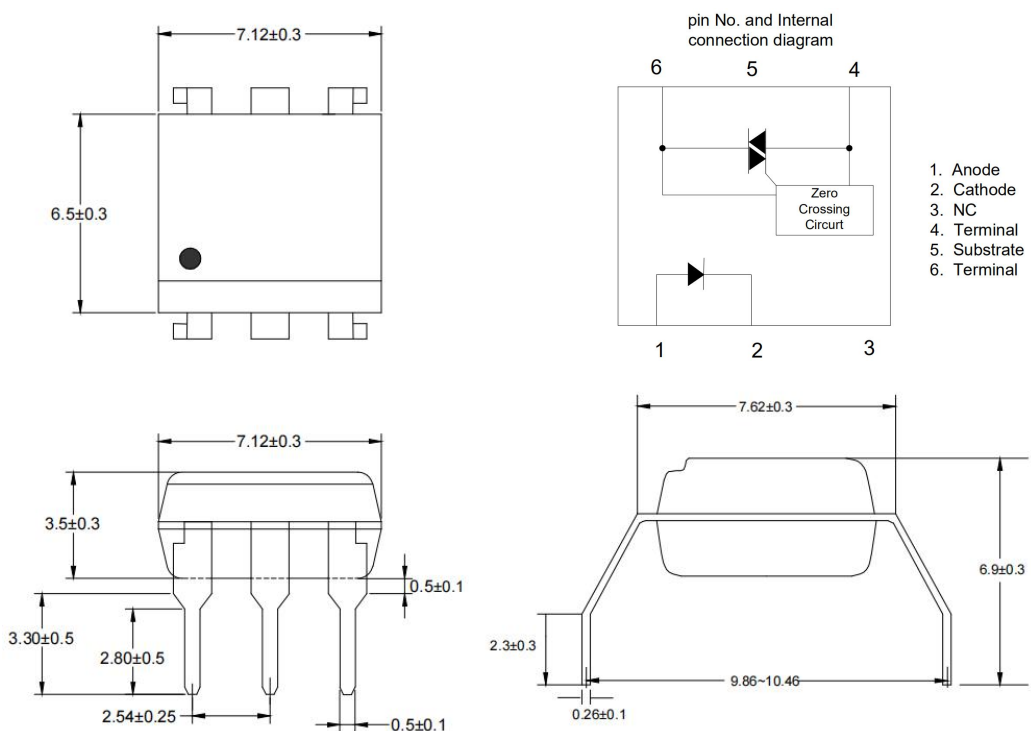

(3).MOC30XX S

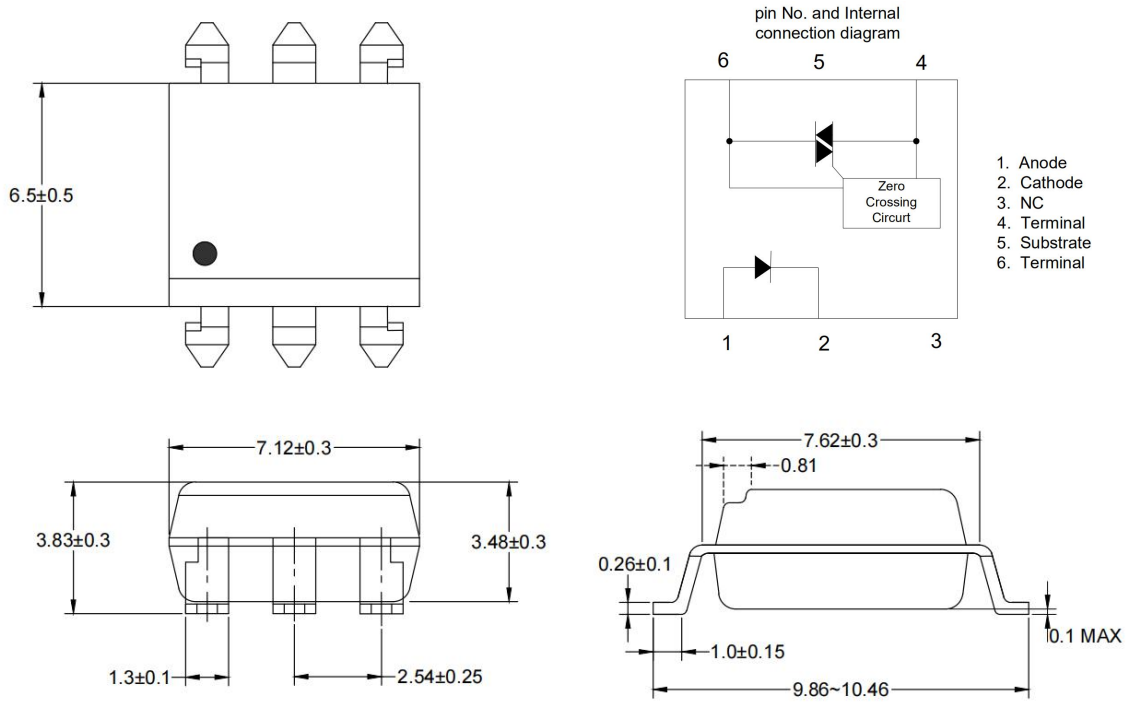

9. RRECOMMENDED FOOT PRINT PATTERNS (MOUNT PAD)

Unit: mm

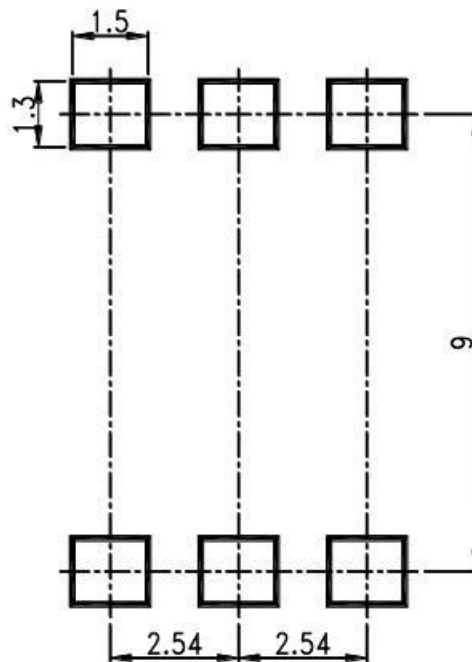

10. Taping Dimensions

(1) .OR-MOC30XXS-TA

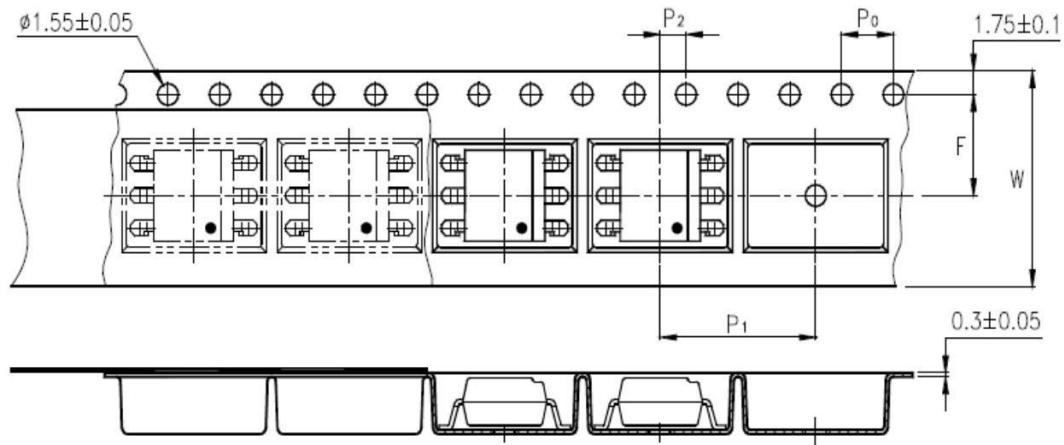

(2) OR-MOC30XXS-TA1

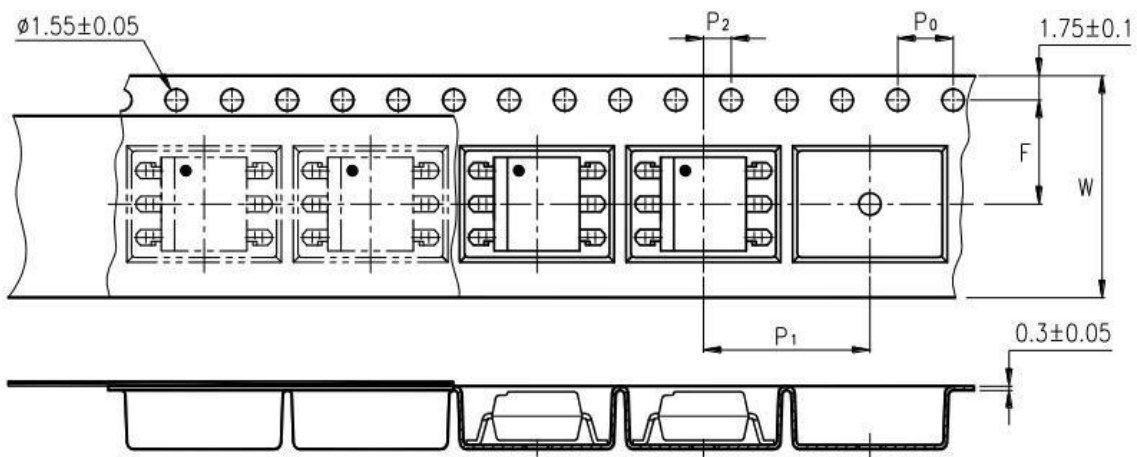

Description	Symbol	Dimension in mm (inch)
Tape wide	W	16±0.3 (0.63)
Pitch of sprocket holes	P ₀	4±0.1 (0.15)
Distance of compartment	F	7.5±0.1 (0.295)
	P ₂	2±0.1 (0.079)
Distance of compartment to compartment	P ₁	12±0.1 (0.472)

Package Type	TA/TA1
Quantities(pcs)	1000

11. Package Dimension

DIP Type

Packing Information	
Packing type	Tube
Qty per Tube	66pcs
Small box (Inner) Dimension	525*128*60mm
Large box (Outer) Dimension	545*290*335mm
The Amount per Inner Box	3,300pcs
The Amount per Outer Box	33,000pcs

SOP Type

Packing Information	
Packing type	Reel type
Tape Width	16mm
Qty per Reel	1,000pcs
Small box (inner) Dimension	345*345*58.5mm
Large box (Outer) Dimension	620x360x360mm
Max qty per small box	2,000pcs
Max qty per large box	20,000pcs

(2)Packing Label Sample



ShenZhen Orient Components Co.,LTD





Material Code : 120PCXXXXXX

|||||

P/N: OR-XXXXXX

|||||

Lot No. : XXXXXX-XXXX-TX-X

|||||

D/C: XXXX

|||||

Qty: XXXX PCS

|||||

内箱码

外箱码

“XXXXXXXXXXXXXXXX” (一体机序列码)

Made in China

Note:

1. Material Code :Product ID.
2. P/N :Contents with "Order Information" in the specification.
3. Lot No. :Product data.
4. D/C :Product weeks.
5. Quantity :Packaging quantity.

12. Temperature Profile Of Soldering

(1).IR Reflow soldering (JEDEC-STD-020C compliant)

One time soldering reflow is recommended within the condition of temperature and time profile shown below. Do not solder more than three times.

Profile item	Conditions
Preheat - Temperature Min (T Smin) - Temperature Max (T Smax) - Time (min to max) (ts)	150°C 200°C 90±30 sec
Soldering zone - Temperature (TL) - Time (t L)	217°C 60 sec
Peak Temperature	260°C
Peak Temperature time	20 sec
Ramp-up rate	3°C / sec max.
Ramp-down rate from peak temperature	3~6°C / sec
Reflow times	≤3

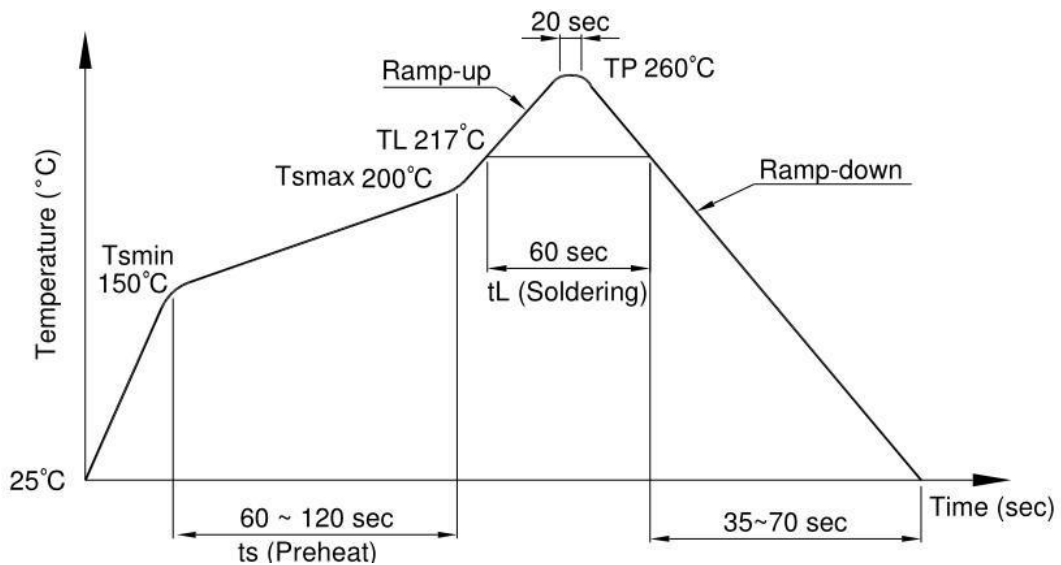

(3) .Wave soldering (JEDEC22A111 compliant)

One time soldering is recommended within the condition of temperature.

Temperature	260+0/-5°C
Time	10 sec
Preheat temperature	5 to 140°C
Preheat time	30 to 80 sec

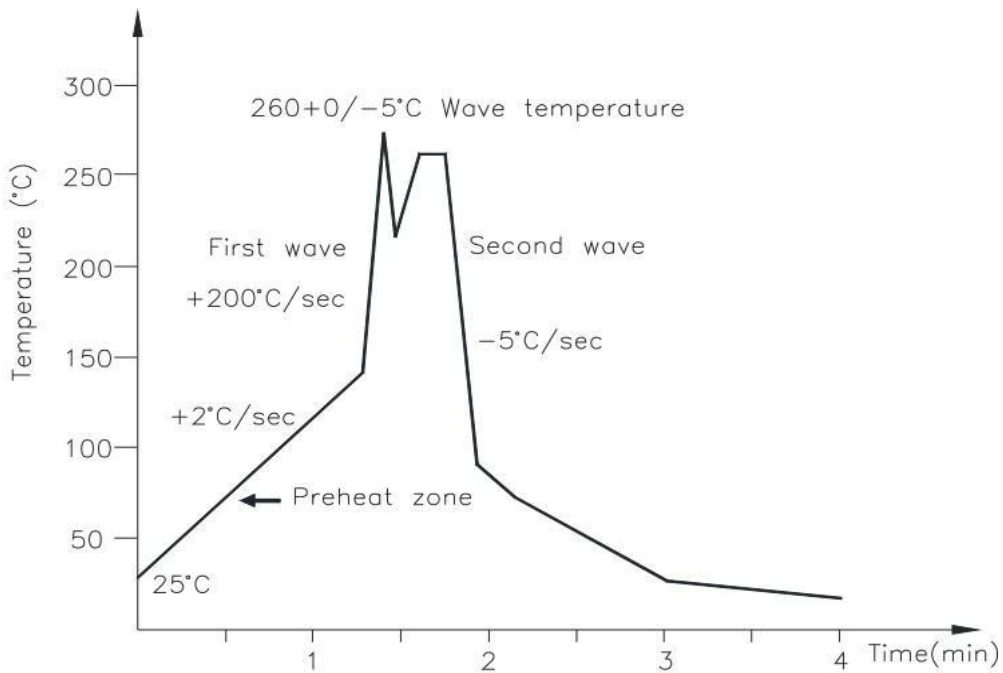

(3).Hand soldering by soldering iron

Allow single lead soldering in every single process. One time soldering is recommended.

Temperature	380+0/-5°C
Time	3 sec max

13. CHARACTERISTICS CURVES (TYPICAL PERFORMANCE)

Fig.1 Forward Current vs. Ambient Temperature

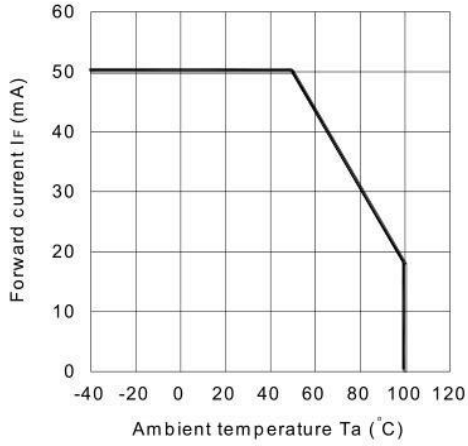

Fig.2 On-state Current vs. Ambient Temperature

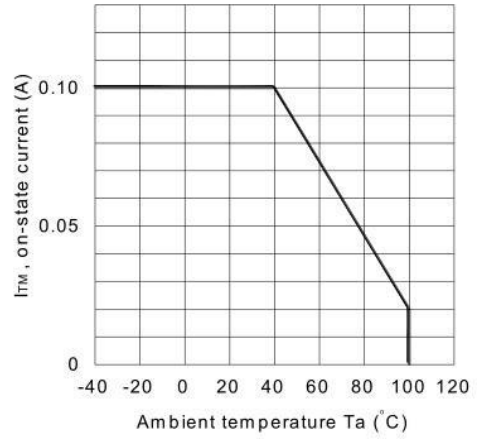

Fig.3 Minimum Trigger Current vs. Ambient Temperature

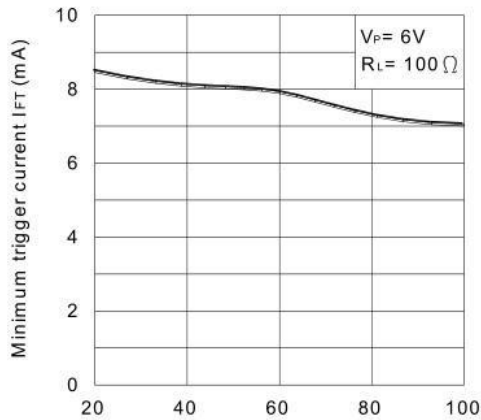

Fig.4 Forward Current vs. Forward Voltage

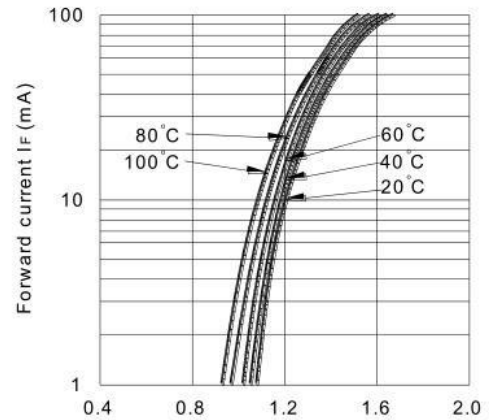

Fig.5 On-state Voltage vs. Ambient Temperature

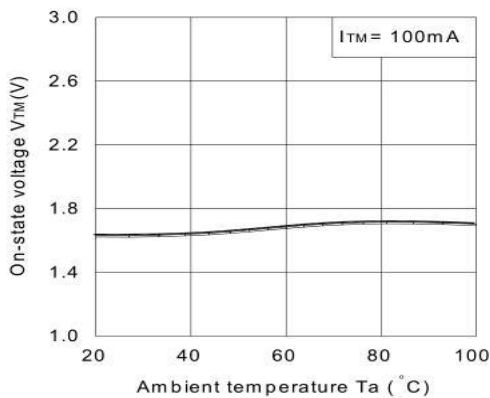

Fig.6 Holding Current vs. Ambient Temperature

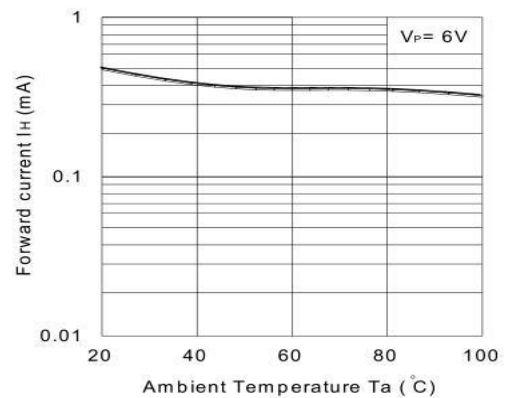

Fig.7 Repetitive Peak Off-state Current vs. Temperature

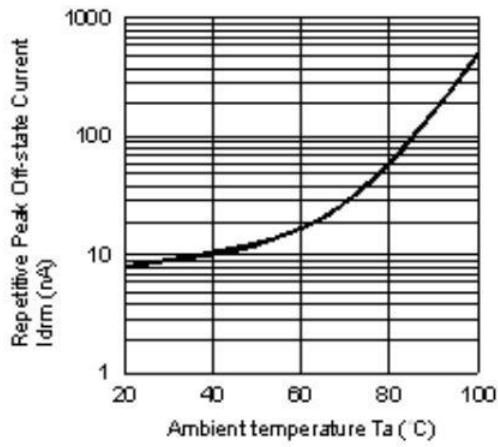
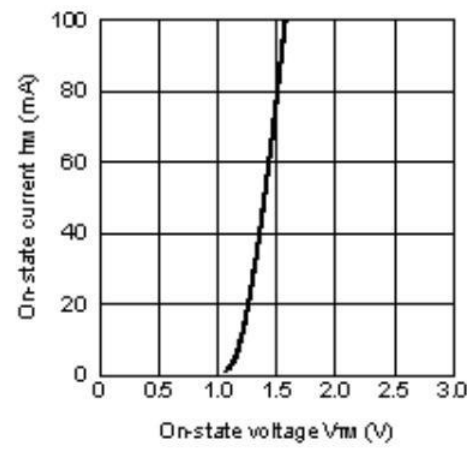
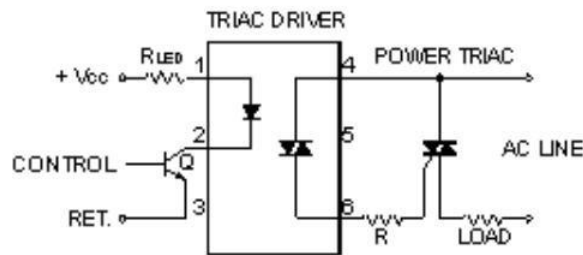

Fig.8 On-state Current vs. On-state Voltage



Basic Driver Circuit



单击下面可查看定价，库存，交付和生命周期等信息

[>>ORIENT\(奥伦德\)](#)