



ORIENT

Photo coupler

Product Data Sheet

Part Number: ORPC-817-(CG)

Customer: _____

Date: _____

SHENZHEN ORIENT COMPONENTS CO., LTD

Block A3rd Floor No.4 Building, Tian'an Cyber Park, Huangge Rd, LongGang Dist, Shenzhen, GD

TEL: 0755-29681817

FAX: 0755-29681200

www.orient-opto.com

1. Features

- (1) Current transfer ratio (CTR : MIN. 50% at $I_F = 5mA$, $V_{CE} = 5V$)
- (2) High input-output isolation voltage ($V_{iso} = 5,000V_{rms}$)
- (3) Response time (t_r : TYP. $4\mu s$ at $V_{CE} = 2V$, $I_C = 2mA$, $R_L = 100\Omega$)
- (4) ESD pass HBM 8000V/MM 2000V
- (5) Safety approval

- UL approved (No.E323844)
- VDE approved(No.40029733)
- CQC approved (No.CQC09001029446)
- CE approved (No.AC/0431008)
- State Grid approved (No.SGCM013420170152)

- (6) In compliance with RoHS, REACH standards
- (7) MSL Class I



2. Description

- (1) ORPC-817-(CG) photo coupler consist of one piece of GaAs emitter and one piece of NPN transistor.
- (2) Packaged in a 4-pin DIP package and available in wide-lead spacing and SMD option.

3. Applications

- (1) Switching power supply
- (2) Ammeter
- (3) Computer
- (4) Instrumental application, measurement machine
- (5) Signal transforming systems
- (6) Imbursement equipments, duplicating machine, automat
- (7) Family-use electric equipments, such as fans

4. Functional Diagram

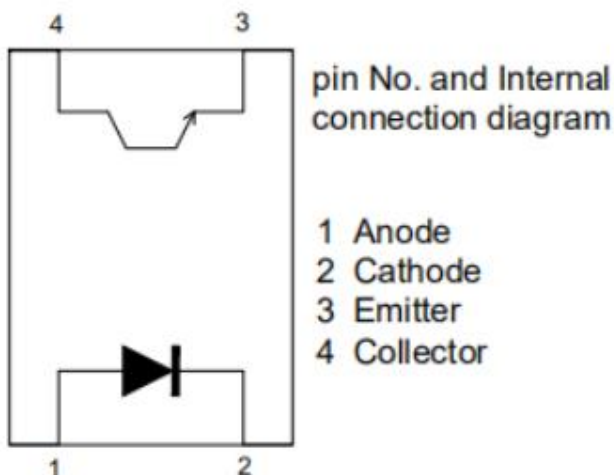

5. Absolute Maximum Ratings at Ta=25°C

Parameter		Symbol	Rated Value	Unit
Input	Forward Current	I_F	60	mA
	Peak forward current (100 μ s pulse, 100Hz frequency)	I_{FP}	1	A
	Reverse Voltage	V_R	6	V
	Input Power	P_I	70	mW
Output	Collector and emitter Voltage	V_{CEO}	80	V
	Emitter and collector Voltage	V_{ECO}	7	
	Collector Current	I_C	50	mA
	Output Power	P_O	150	mW
Total Consume Power		P_{tot}	200	mW
*1 Isolation Voltage		V_{iso}	5,000	Vrms
Max Insulation Voltage (Insulating oil test)		V_{IOTM}	10,000	V
Rated Impulse Insulation Voltage		V_{IORM}	630	V
Operation Temperature		T_{opr}	-55 to + 125	°C
Storage Temperature		T_{stg}	-55 to + 150	
*2 Soldering Temperature		T_{sol}	260	

*1.AC For 1 Minute, R.H. = 40 ~ 60%

Isolation voltage shall be measured using the following method.

- (1) Short between anode and cathode on the primary side and between collector and emitter on the secondary side.
- (2) The isolation voltage tester with zero-cross circuit shall be used.
- (3) The waveform of applied voltage shall be a sine wave.

*2. Soldering time is 10 seconds

6. Electro-Optical Characteristics (Ta=25°C unless specified otherwise)

Parameter		Symbol	Condition	Min	Typ.*	Max	Unit
Input	Forward Voltage	V_F	$I_F=20\text{mA}$	---	1.2	1.4	V
	Reverse Current	I_R	$V_R=5\text{V}$	---	---	5	μA
	Input Capacitance	C_t	$V=0, f=1\text{KHz}$	---	30	250	pF
Output	Dark Current	I_{CEO}	$V_{CE}=20\text{V}, I_F=0\text{mA}$	---	---	100	nA
	Collector and Emitter attenuation Voltage	BV_{CEO}	$I_C=0.1\text{mA}, I_F=0\text{mA}$	80	---	---	V
	Emitter and Collector attenuation Voltage	BV_{ECO}	$I_E=0.1\text{mA}, I_F=0\text{mA}$	7	---	---	V
Transforming Characteristics	*1 Current transfer ratio	CTR	$I_F=5\text{mA}, V_{CE}=5\text{V}$	50	---	600	%
	Collector Current	I_C		2.5	---	30	mA
	Collector and Emitter Saturation Voltage	$V_{CE(sat)}$	$I_F=20\text{mA}, I_C=1\text{mA}$	---	0.1	0.2	V
	Isolation Impedance	R_{iso}	DC500V 40~60%R.H.	5×10^{10}	1×10^{12}	---	Ω
	Floating Capacitance	C_f	$V=0, f=1\text{MHz}$	---	0.6	1.0	pF
	Cut-off Frequency	f_c	$V_{CE}=5\text{V}, I_C=2\text{mA}, R_L=100\Omega, -3\text{dB}$	---	80	---	kHz
	Rise Time	t_r	$V_{CE}=2\text{V}, I_C=2\text{mA}, R_L=100\Omega$	---	4	18	μs
	Fall Time	t_f		---	3	18	μs

*1 Current Conversion Ratio = $I_C / I_F \times 100\%$, CTR Tolerance: $\pm 3\%$.

7. Rank Table of Current Transfer Ratio

(1) ORPC-817

Grade Sign	Min (%)	Max (%)
ORPC-817L	50	100
ORPC-817A	80	160
ORPC-817B	130	260
ORPC-817C	200	400
ORPC-817D	300	600
ORPC-817X	100	200
ORPC-817Y	200	300
ORPC-817Z	300	400

Note: Working condition: $I_F=5\text{mA}$, $V_{CE}=5\text{V}$, $T_a=25^\circ\text{C}$.

(2) ORPC-817M

Grade Sign	Min (%)	Max (%)
ORPC-817ML	50	100
ORPC-817MA	80	160
ORPC-817MB	130	260
ORPC-817MC	200	400
ORPC-817MD	300	600
ORPC-817MX	100	200
ORPC-817MY	200	300
ORPC-817MZ	300	400

Note: Working condition: $I_F=5\text{mA}$, $V_{CE}=5\text{V}$, $T_a=25^\circ\text{C}$.

(3) ORPC-817S

Grade Sign	Min (%)	Max (%)
ORPC-817SL	50	100
ORPC-817SA	80	160
ORPC-817SB	130	260
ORPC-817SC	200	400
ORPC-817SD	300	600
ORPC-817SX	100	200
ORPC-817SY	200	300
ORPC-817SZ	300	400

Note: Working condition: $I_F=5\text{mA}$, $V_{CE}=5\text{V}$, $T_a=25^\circ\text{C}$.



8. Order Information

Part Number

ORPC-817XT-V-W-Y-Z-(CG)

Note

X = Lead form option (S, M or none)

T = CTR Rank (L, A, B, C, D, X, Y or none)

V = Tape and reel option (TP, TP1 or none).

W = Lead frame (F:Iron, C:copper)

Y = 'V' code for VDE safety (This options is not necessary).

Z = 'G' code for Halogen free.

CG = Field Code.

* VDE Code can be selected.

Option	Description	Packing quantity
None	Standard DIP-4	100 units per tube
M	Wide lead bend (0.4 inch spacing)	100 units per tube
S(TP)	Surface mount lead form (low profile) + TP tape & reel option	2000 units per reel
S(TP1)	Surface mount lead form (low profile) + TP1 tape & reel option	2000 units per reel

9. Naming Rule

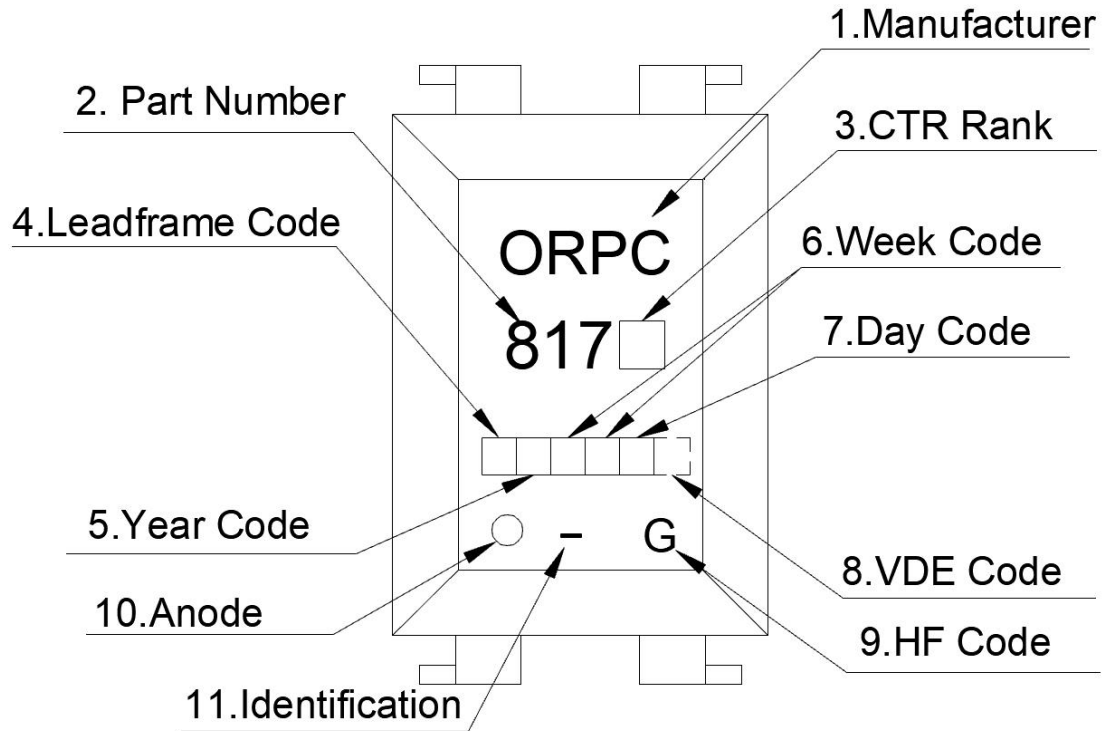

- (1) ORIENT PHOTOCOUPLER.
- (2) 817 denotes Device Part Number.
- (3) □ denotes Rank Code.
- (4) □ denotes Lead Frame Code.
- (5) □ denotes Year Code.
- (6) □□ denotes Week Code.
- (7) □ denotes Day Code.
- (8) □□□ denotes VDE Code. (Optional)
- (9) G denotes HF Code.
- (10) Anode.
- (11) Identification.

* VDE Mark can be selected.

10. Package Dimension (Unit: mm)

(1) ORPC-817

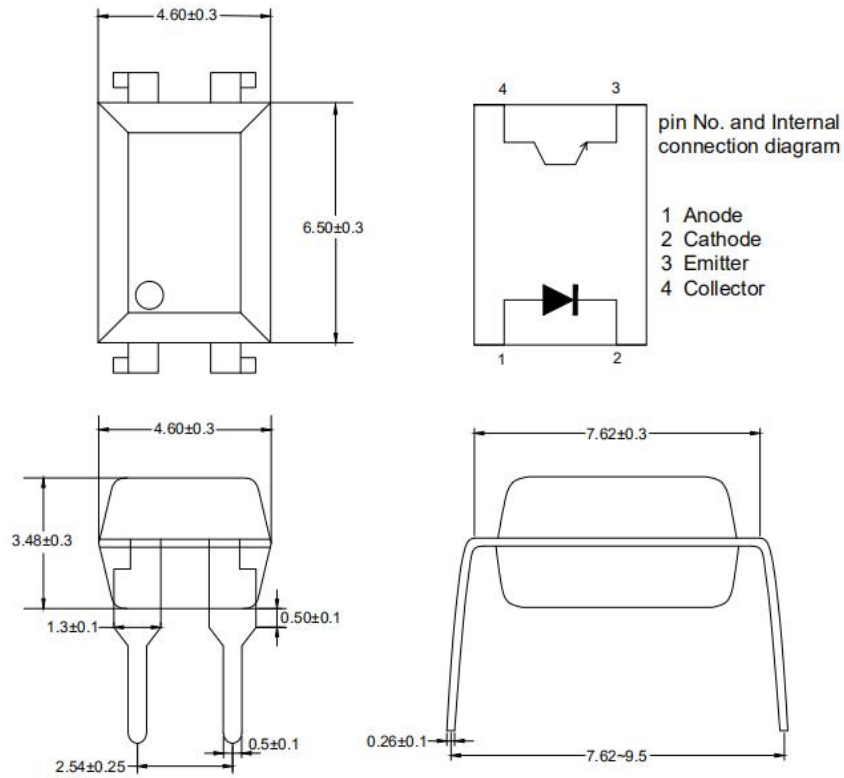

(2) ORPC-817M

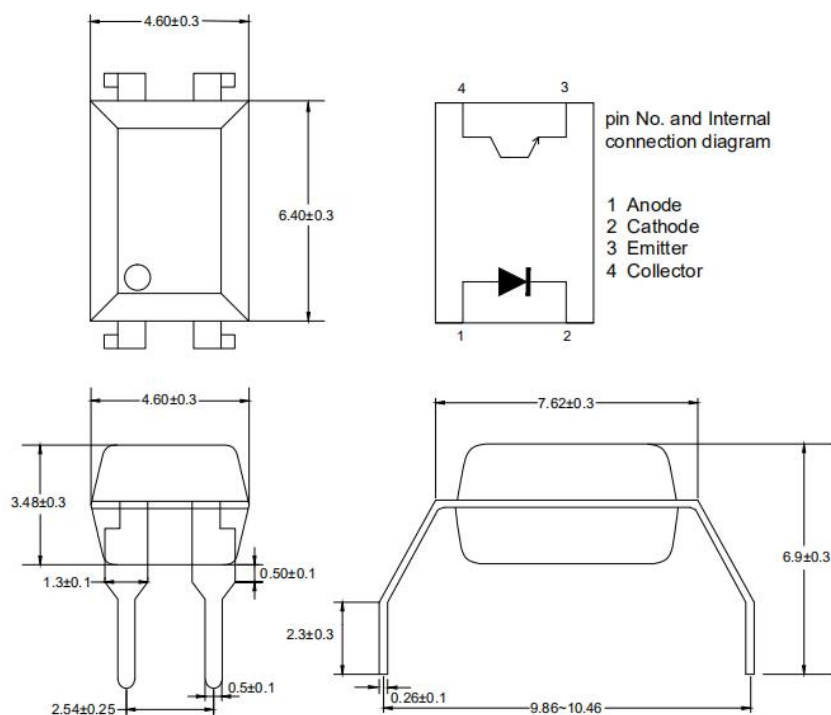

(3) ORPC-817S

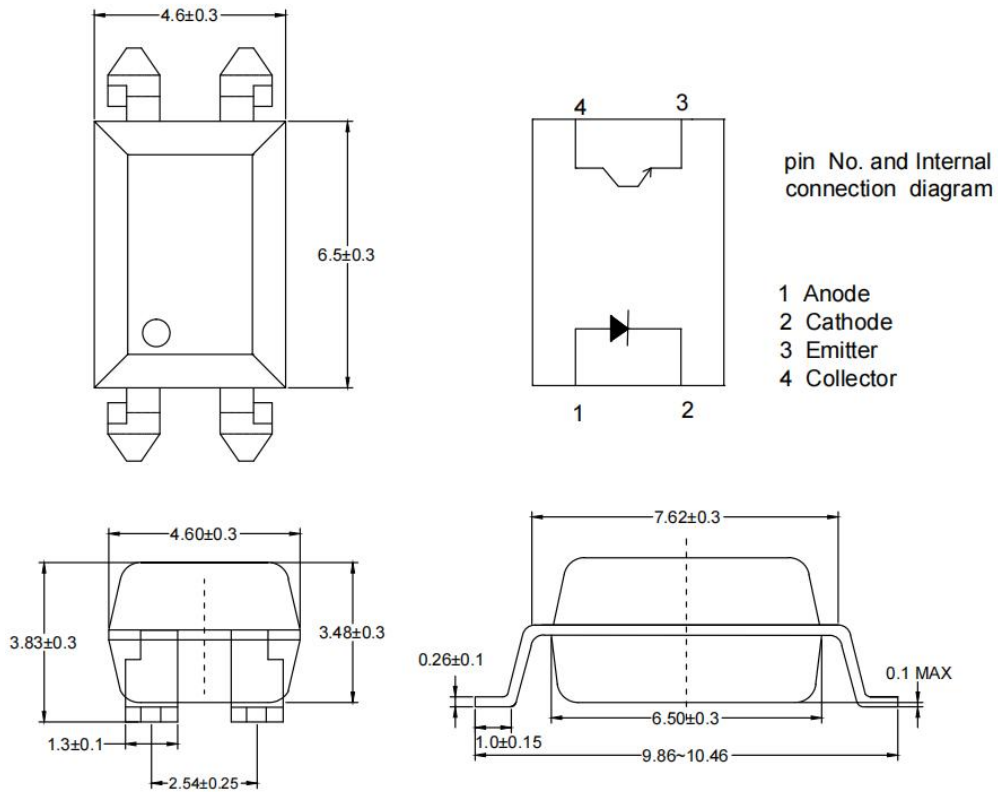

11. Taping Dimensions

(1)ORPC-817S-TP

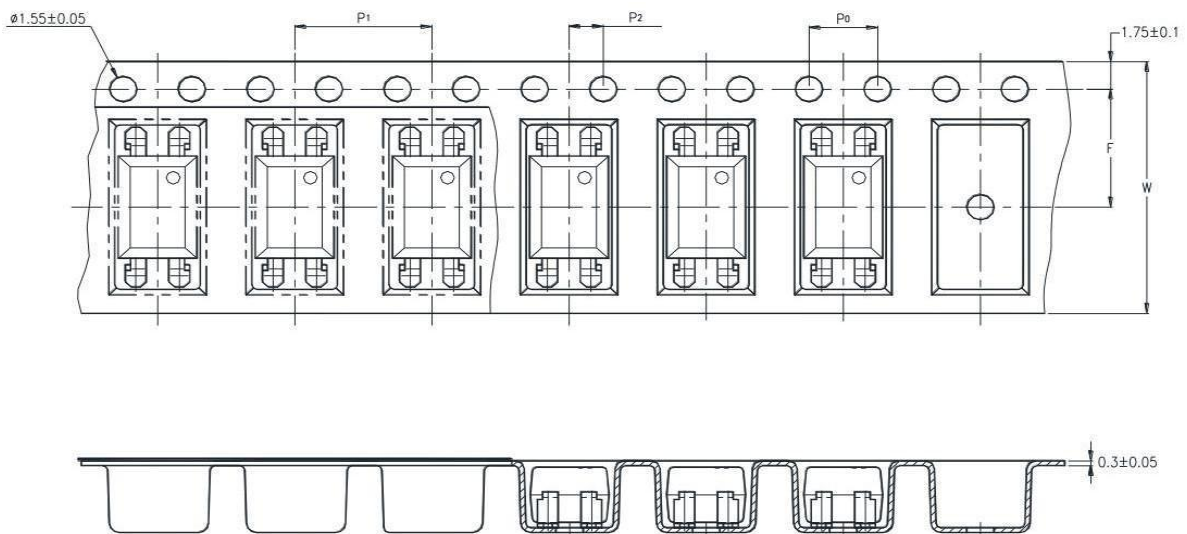

(2)ORPC-817S-TP1

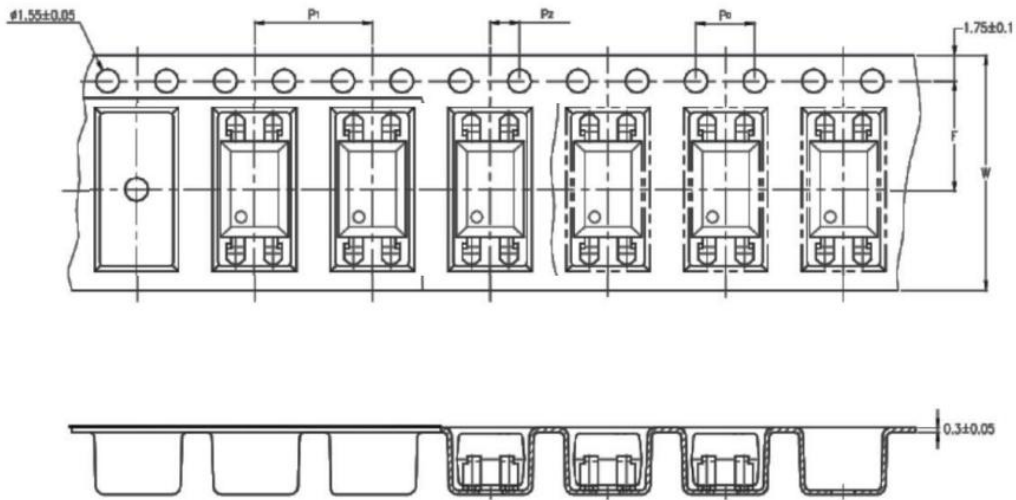

Description	Symbol	Dimension in mm (inch)
Tape wide	W	16±0.3 (.63)
Pitch of sprocket holes	P ₀	4±0.1 (.15)
Distance of compartment	F	7.5±0.1 (.295)
	P ₂	2±0.1 (.0079)
Distance of compartment to compartment	P ₁	8±0.1 (.472)

Package Type	TP/TP1
Quantities(pcs)	2000

12. Recommended Foot Print Patterns (Mount Pad) (Unit: mm)

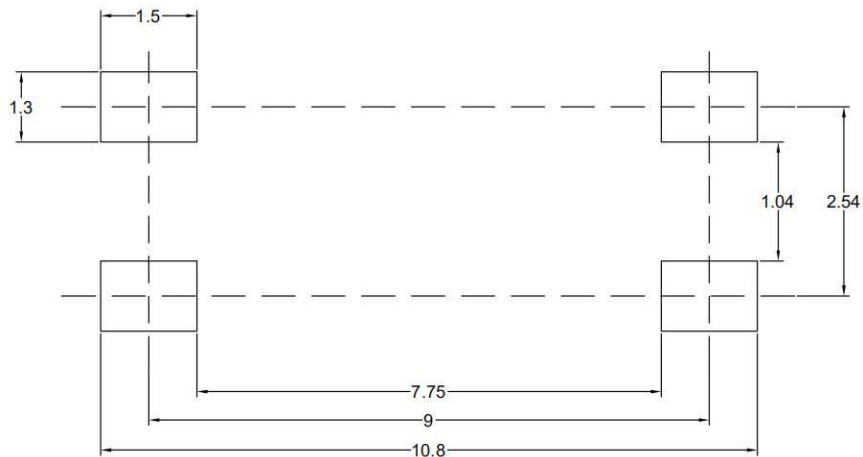

13. Package Dimension



DIP Type

Packing Information	
Packing type	Tube
Qty per Tube	100pcs
Small box (Inner) Dimension	525*128*60mm
Large box (Outer) Dimension	545*290*335mm
The Amount per Inner Box	5,000pcs
The Amount per Outer Box	50,000pcs

SOP Type



Packing Information	
Packing type	Reel type
Tape Width	16mm
Qty per Reel	2,000pcs
Small box (inner) Dimension	345*345*58.5mm
Large box (Outer) Dimension	620x360x360mm
Max qty per small box	4,000pcs
Max qty per large box	40,000pcs

(2)Packing Label Sample

Material Code : 120PCXXXXXX

P/N:OR-XXXXXX

Lot No. :XXXXXX-XXXXX-TX-X

D/C:XXXX

Qty:XXXX PCS

内箱码

外箱码

“XXXXXXXXXXXXXXXX” (一体机序列码)
Made in China

Note:

1. Material Code :Product ID.
2. P/N :Contents with "Order Information" in the specification.
3. Lot No. :Product data.
4. D/C :Product weeks.
5. Quantity :Packaging quantity.

14. Reliability Test

NO.	ITEMS	Reliability Testing				
		QTY. (Pcs)	Condition	Process	Device	Standard
1	RSH 耐焊接热	22	260±5℃	10s/3 次	锡炉	JESD22-A106
2	HTSL 高温存储	77	125℃	168 hrs	高温烤箱 测试仪	JESD22-A103
				500 hrs		
				1000 hrs		
3	LTSL 低温存储	77	-55℃	168 hrs	低温箱 测试仪	JESD22-A119
				500 hrs		
				1000 hrs		
4	TC 温度循环	77	H:125℃ 15min ∫ 5min L:-55℃ 15min	300 cycle	冷热冲击机	JESD22-A104
5	TS 温度冲击	77	H:100℃ 5min ∫ 15s L:-40℃ 5min	300 cycle	冷热冲击机	JESD22-A106
6	HTOL 高温操作	77	110℃ IF=10mA Vce=5V	168 hrs	高温烤箱 测试仪、老 化电路板	JESD22-A108
				500 hrs		
				1000 hrs		
7	ESD-HBM 人体模式	22	≥8KV 1Cycle	1次	ESD静电测 试仪	JESD22-A114
8	SD 可焊性	22	Pb-free 245±5℃	5S/1次	锡炉	JESD22-B102
9	HTRB 高温反向偏压	77	HTRB @125℃ Vce=80v	168 hrs	高温烤箱 , 测试仪	JESD22-A103
				500 hrs		
				1000 hrs		
10	H3TRB 温湿度反向偏 压, 寿命试验	77	H3TRB 85℃,85%RH Vce=80v	168 hrs	恒温恒湿 机, 测试仪	JESD22-A101
				500 hrs		
				1000 hrs		
11	Autoclave 压力锅	77	Ta=121 ℃,100%RH,2atm	96hrs	压力锅	JESD22-A102

15. Temperature Profile Of Soldering

(1).IR Reflow soldering (JEDEC-STD-020C compliant)

One time soldering reflow is recommended within the condition of temperature and time profile shown below. Do not solder more than three times.

Profile item	Conditions
Preheat	
- Temperature Min (T Smin)	150°C
- Temperature Max (T Smax)	200°C
- Time (min to max) (ts)	90±30 sec
Soldering zone	
- Temperature (TL)	217°C
- Time (t L)	60 sec
Peak Temperature	260°C
Peak Temperature time	20 sec
Ramp-up rate	3°C / sec max.
Ramp-down rate from peak temperature	3~6°C / sec
Reflow times	≤3

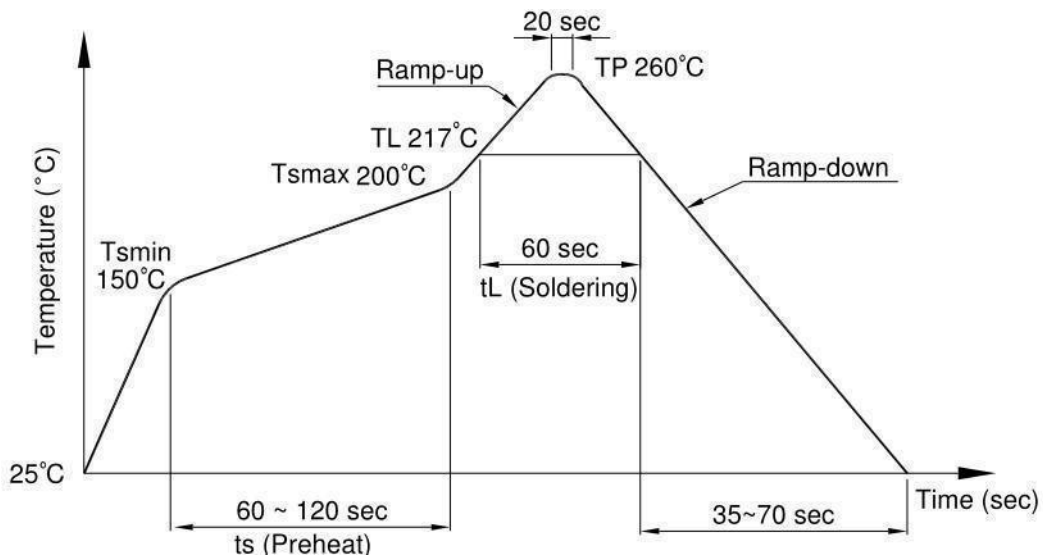

(2).Wave soldering (JEDEC22A111 compliant)

One time soldering is recommended within the condition of temperature.

Temperature	260+0/-5°C
Time	10 sec
Preheat temperature	25 to 140°C
Preheat time	30 to 80 sec

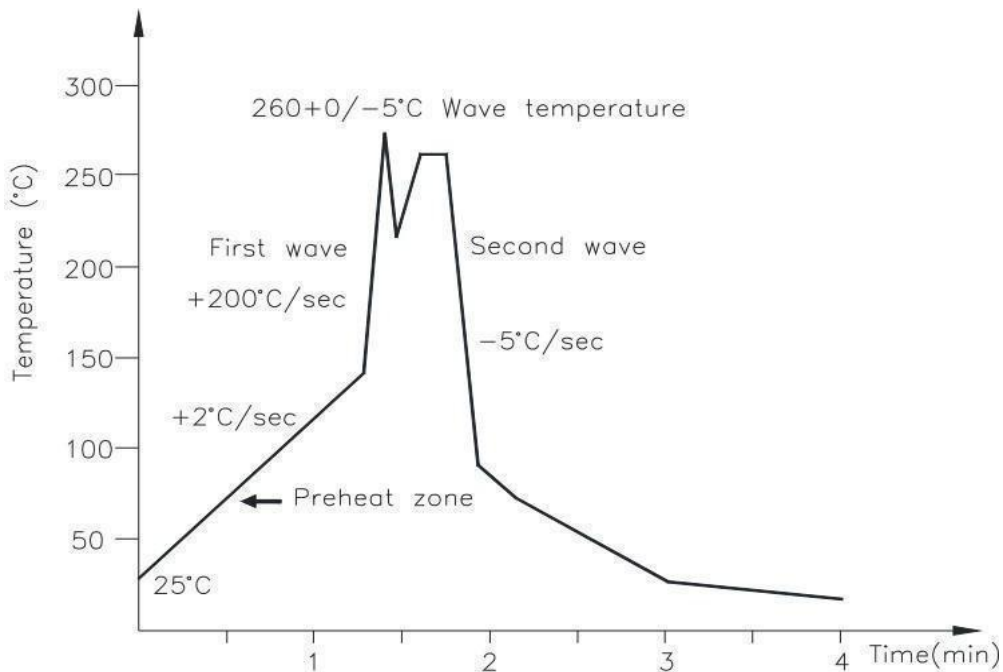

(3).Hand soldering by soldering iron

Allow single lead soldering in every single process. One time soldering is recommended.

Temperature	380+0/-5°C
Time	3 sec max

16. Characteristics Curves

Fig.1 Forward current vs Ambient temperature

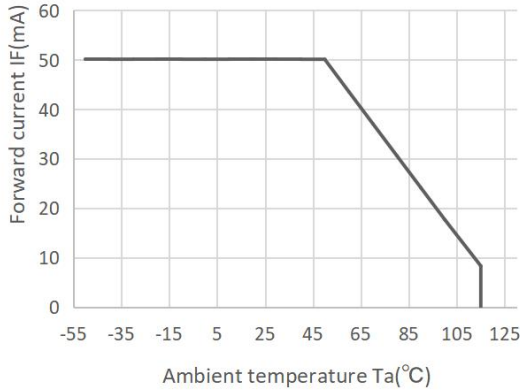

Fig.2 Collector Power Dissipation vs. Ambient temperature

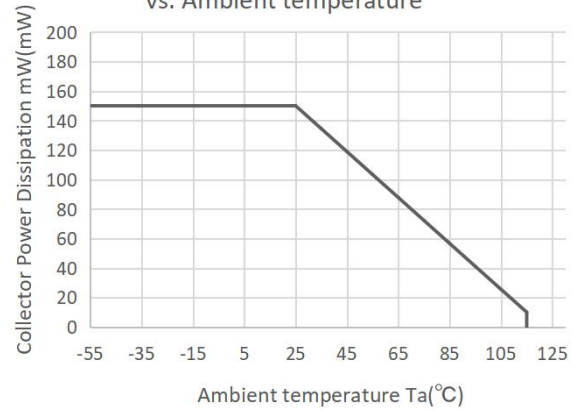

Fig.3 Collector-emitter Saturation Voltage vs. Forward Current

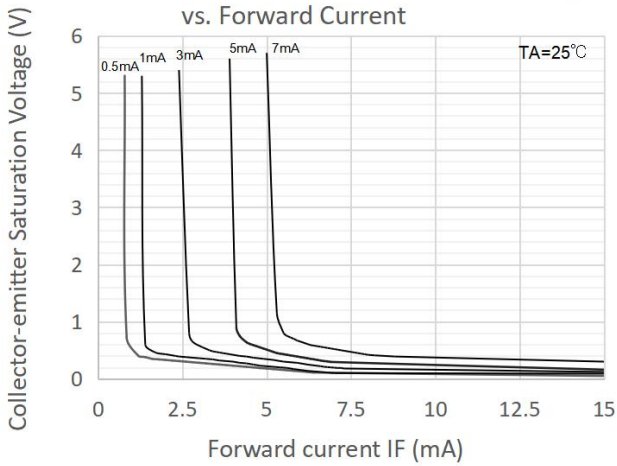

Fig.4 Forward Current vs. Forward Voltage

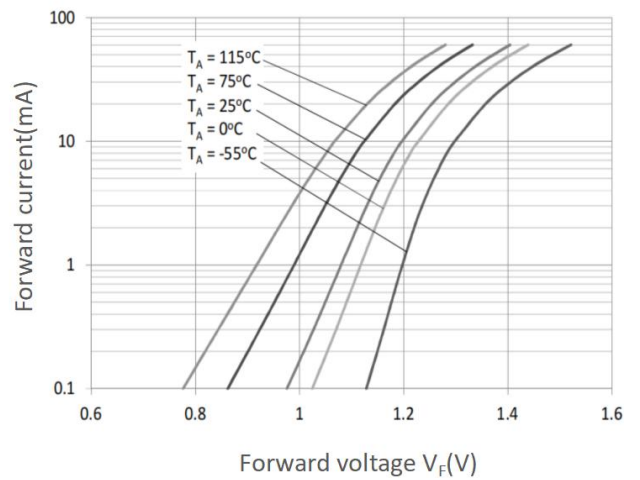

Fig.5 Forward Current vs. Current Transfer Ratio

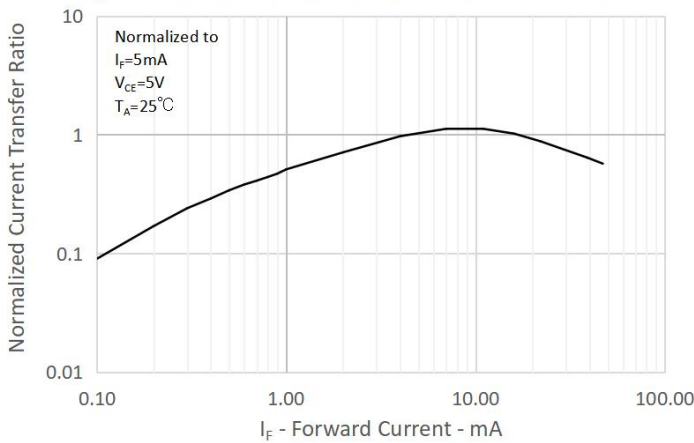

Fig.6 Collector Current vs. Collector-emitter Voltage

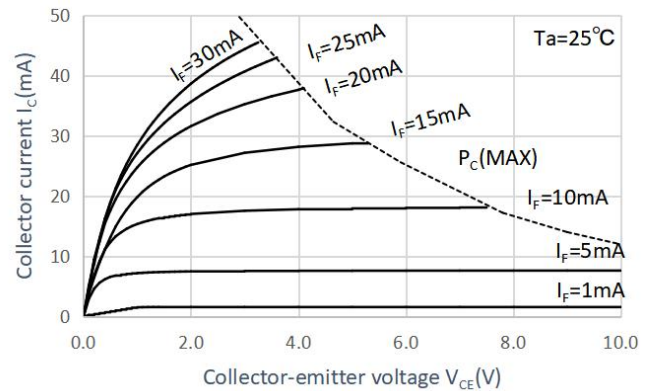

Fig.7 Relative Current Transfer Ratio vs. Ambient Temperature

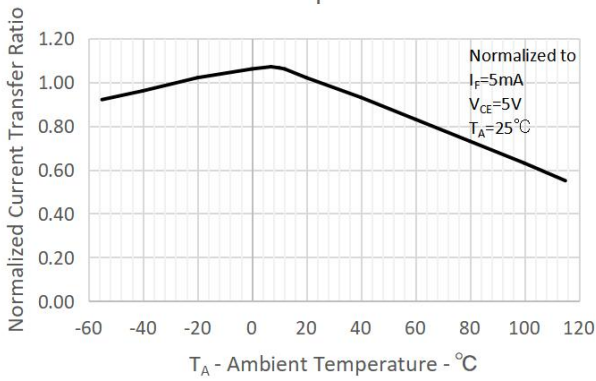

Fig.8 Collector-emitter Saturation Voltage vs. Ambient Temperature

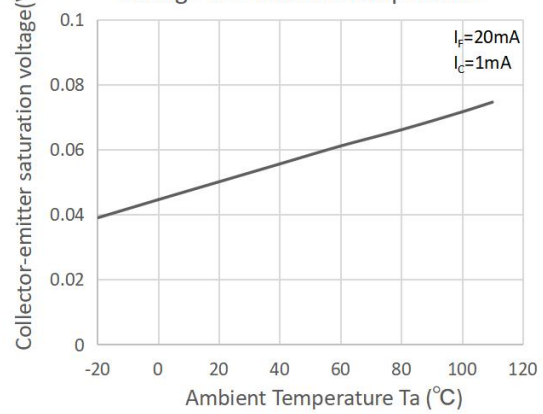

Fig.9 Collector Dark Current vs. Ambient Temperature

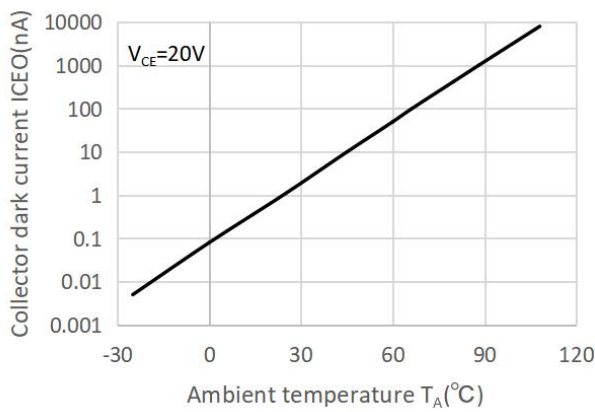

Fig.10 Respinse Time vs. Load Resistance

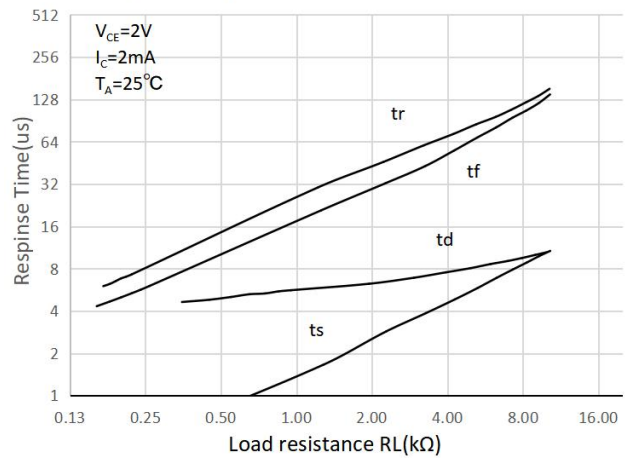
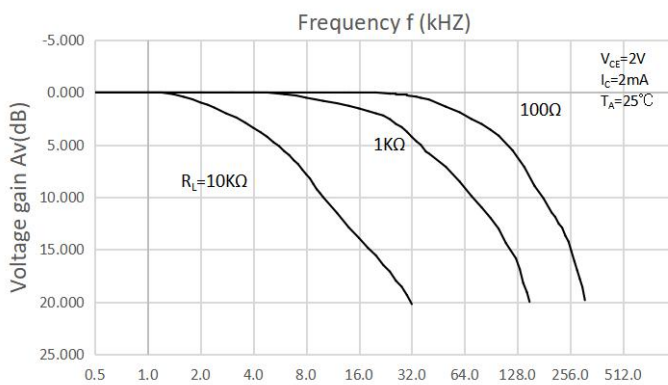
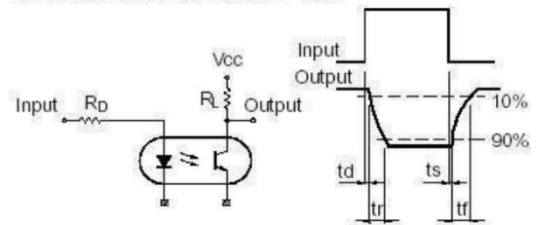

Fig.11 Frequency Response



Test Circuit for Response Time



Test Circuit for Frequency Response

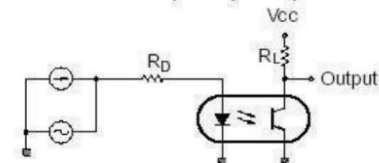

单击下面可查看定价，库存，交付和生命周期等信息

[>>ORIENT\(奥伦德\)](#)