



ORIENT

Photo coupler

Product Data Sheet

Part Number: OR-3H7

Customer: _____

Date: _____

SHENZHEN ORIENT COMPONENTS CO.,LTD.

Block A 3rd Floor No.4 Building,Tian'an Cyber Park,Huangge Rd,LongGangDist,Shenzhen,GD

TEL: 0755-29681816

FAX: 0755-29681200

www.orient-opto.com

1. Features

- (1) Current transfer ratio(CTR) : MIN. 50% at $I_F = 5\text{mA}$, $V_{CE} = 5\text{V}$, $T_a = 25^\circ\text{C}$
- (2) High input-output isolation voltage. ($V_{ISO} = 3,750\text{Vrms}$)
- (3) Collector and emitter Voltage : 80V(MIN)
- (4) Operating Temperature : -55°C to 125°C
- (5) Safety approval

UL approved(No.E323844)

VDE approved(No.40029733)

CQC approved (No.CQC19001231254)

- (6) In compliance with RoHS, REACH standards
- (7) MSL Class I



2. Instructions

The OR-3H7 series device contains an infrared led and a photo transistor detector. They are encapsulated in a 4-pin SOP, free of halogens and Sb_2O_3

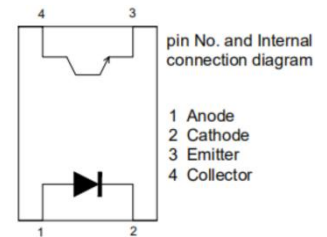

3. Application Range

- (1) Mixed PCB substrate requiring high density installation
- (2) Programmable controller
- (3) System apparatus and measuring instruments

4. Max Absolute rated Value (Normal Temperature= 25°C)

| Parameter | | Symbol | Rated Value | Unit |
|----------------------------------|---|------------|--------------|------------------|
| Input | Forward Current | I_F | 50 | mA |
| | Peak forward current($t=10\mu\text{s}$) | I_{FM} | 1 | A |
| | Reverse Voltage | V_R | 6 | V |
| | Power Dissipation | P | 70 | mW |
| | Junction Temperature | T_j | 125 | $^\circ\text{C}$ |
| Output | Collector and emitter Voltage | V_{CEO} | 80 | V |
| | Emitter and collector Voltage | V_{ECO} | 7 | |
| | Collector Current | I_C | 50 | mA |
| | Power Dissipation | P_C | 150 | mW |
| | Junction Temperature | T_j | 125 | $^\circ\text{C}$ |
| Total Power Dissipation | | P_{tot} | 200 | mW |
| *1 Insulation Voltage | | V_{iso} | 3750 | Vrms |
| Rated Impulse Insulation Voltage | | V_{IORM} | 630 | V |
| Operating Temperature | | T_{opr} | -55 to + 125 | $^\circ\text{C}$ |
| Storage Temperature | | T_{stg} | -55 to + 150 | |
| *2 Soldering Temperature | | T_{sol} | 260 | |

*1. AC For 1 Minute, R.H. = 40 ~ 60%

Isolation voltage shall be measured using the following method.

- (1) Short between anode and cathode on the primary side and between collector and emitter on the secondary side
- (2) The isolation voltage tester with zero-cross circuit shall be used.
- (3) The waveform of applied voltage shall be a sine wave.

*2.soldering time is 10 seconds

5. Opto-electronic Characteristics(Normal Temperature=25°C)

| Parameter | | Symbol | Min | Typ.* | Max | Unit | Condition |
|------------------------------|--------------------------------------|---------------|--------------------|--------------------|-----|---------------|--|
| Input | Forward Voltage | V_F | --- | 1.2 | 1.4 | V | $I_F=20\text{mA}$ |
| | Reverse Current | I_R | --- | --- | 5 | μA | $V_R=5\text{V}$ |
| | Terminal Capacitance | C_t | --- | 30 | 250 | pF | $V=0, f=1\text{KHz}$ |
| Output | Collector Dark Current | I_{CEO} | --- | --- | 100 | nA | $V_{CE}=20\text{V}$ $I_F=0\text{mA}$ |
| | Collector-Emitter Breakdown Voltage | BV_{CEO} | 80 | --- | --- | V | $I_C=0.1\text{mA}$ $I_F=0\text{mA}$ |
| | Emitter-Collector Breakdown Voltage | BV_{ECO} | 7 | --- | --- | V | $I_E=0.1\text{mA}$ $I_F=0\text{mA}$ |
| Transforming Characteristics | *1 Current Transfer Ratio | CTR | 50 | --- | 600 | % | $I_F=5\text{mA}$ $V_{CE}=5\text{V}$ |
| | Collector Current | I_C | 2.5 | --- | 30 | mA | |
| | *1 Current Transfer Ratio | CTR | 100 | --- | 600 | % | $I_F=0.5\text{mA}$ $V_{CE}=5\text{V}$ |
| | Collector Current | I_C | 0.5 | --- | 3 | mA | |
| | Collector-Emitter Saturation Voltage | $V_{CE(sat)}$ | --- | --- | 0.4 | V | $I_F=8\text{mA}$ $I_C=2.4\text{mA}$ |
| | Insulation Impedance | R_{iso} | 5×10^{10} | 1×10^{11} | --- | Ω | DC500V 40~60%R.H. |
| | Floating Capacitance | C_f | --- | 0.6 | 1 | pF | $V=0, f=1\text{MHz}$ |
| | Response Time | t_r | --- | 3 | 18 | μs | $V_{CE}=10\text{V}$ $I_C=2\text{mA}$ |
| | Descend Time | t_f | --- | 4 | 18 | μs | $R_L=100\Omega$ |

- Current Conversion Ratio = $I_C / I_F \times 100\%$

6. Rank table of current transfer ratio CTR

| MODEL NO. | CTR Rank | Min. | Max. | Condition | Unit |
|-----------|----------|------|------|--|------|
| OR-3H7 | A | 80 | 160 | IF=5mA, V _{CE} =5V, Ta=25°C | % |
| | B | 130 | 260 | | |
| | C | 200 | 400 | | |
| | D | 300 | 600 | | |
| | No Mark | 50 | 600 | IF=0.5mA, V _{CE} =5V, Ta=25°C | |
| | AL | 100 | 200 | | |
| | BLL | 200 | 400 | IF=5mA, V _{CE} =5V, Ta=25°C | |
| | GB | 100 | 600 | IF=0.5mA, V _{CE} =5V, Ta=25°C | |

- Current Conversion Ratio = $I_C / I_F \times 100\%$

7. Order Information

Part Number

OR-3H7X-W-Y-Z

Note

X = CTR Rank (A , B, C, D, AL, BLL, GB or none)
W = Tape and reel option (TP or TP1).
Y = ‘V’ code for VDE safety (This options is not necessary).
Z = ‘G’ code for Halogen free.

- * VDE Code can be selected.
- * Halogen Free Code can be selected.

| Option | Description | Packing quantity |
|--------|--|---------------------|
| TP | Surface mount lead form (low profile) + TP tape & reel option | 3000 units per reel |
| TP1 | Surface mount lead form (low profile) + TP1 tape & reel option | 3000 units per reel |

8. Naming Rule

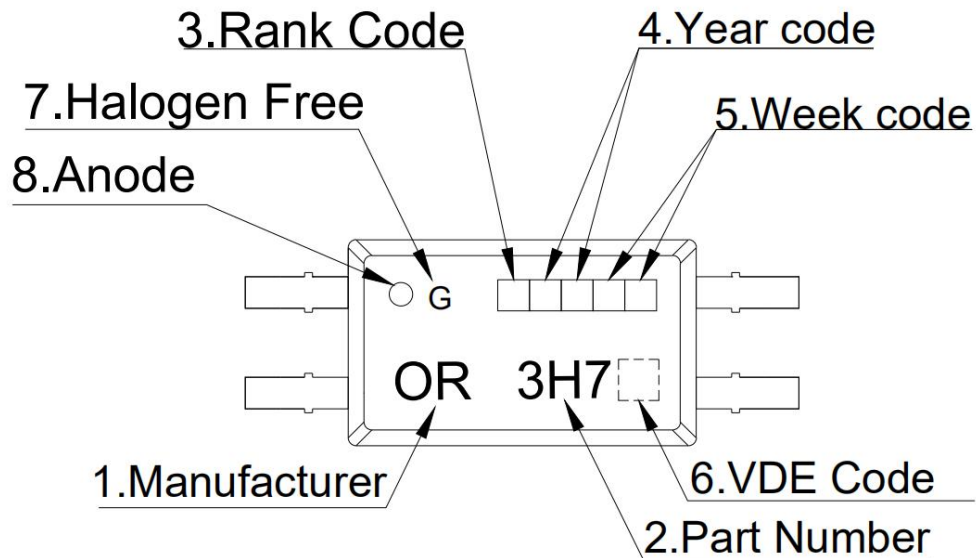

1. Manufacturer : ORIENT.
2. Part Number : 3H7.
3. Rank Code : CTR Rank
4. Year Code : '21' means '2021' and so on.
5. Week Code : 01 means the first week, 02 means the second week and so on.
6. VDE Code .
7. HF Code 'G': Halogen Free.
8. Anode.

* VDE Code can be selected.

9. Outer Dimension

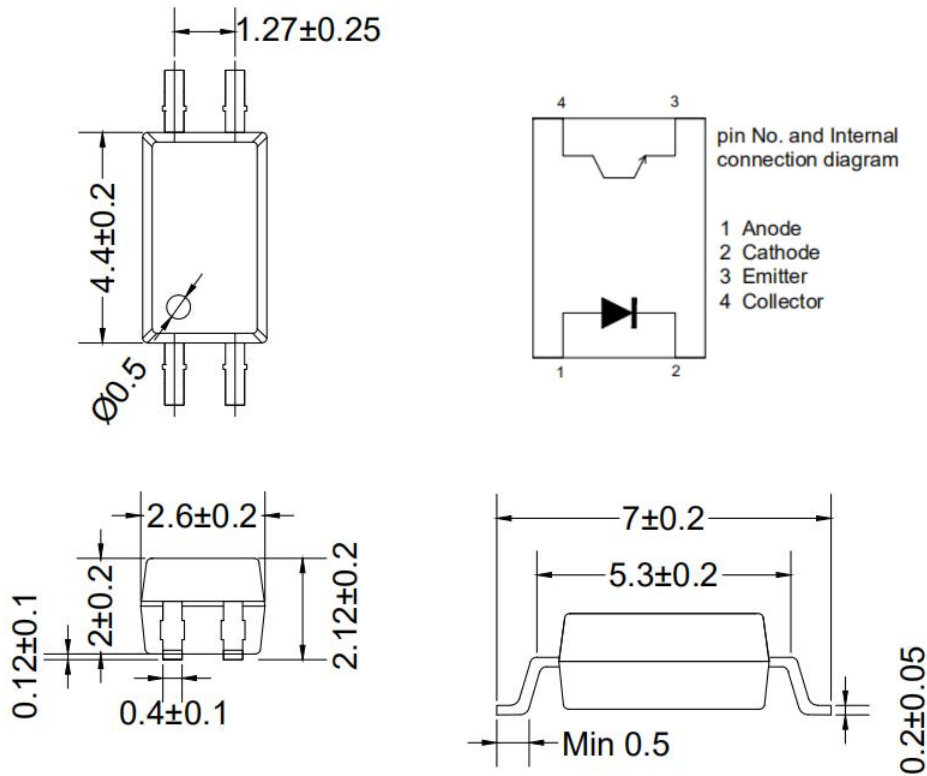

10. Recommended Foot Print Patterns (Mount Pad) (Unit:mm)

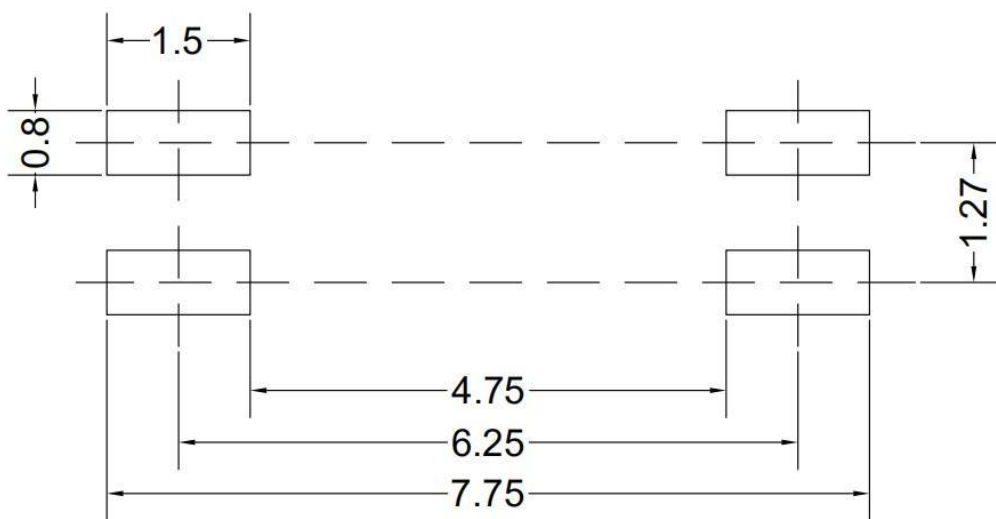

11. Taping Dimensions

(1)OR-3H7-TP

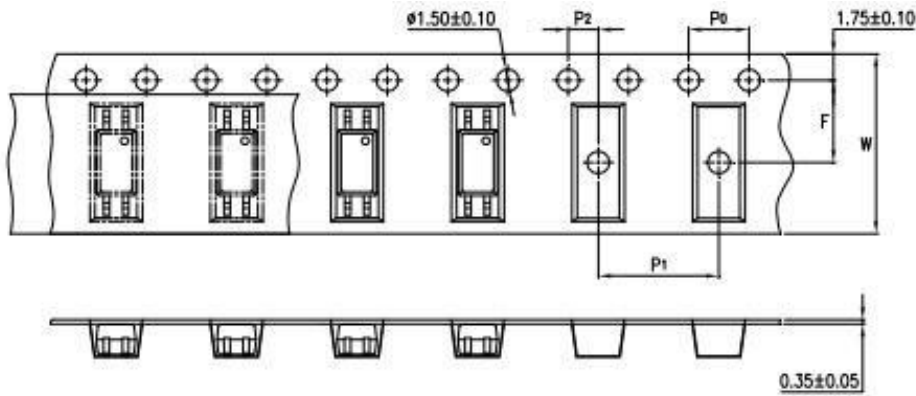

(2)OR-3H7-TP1

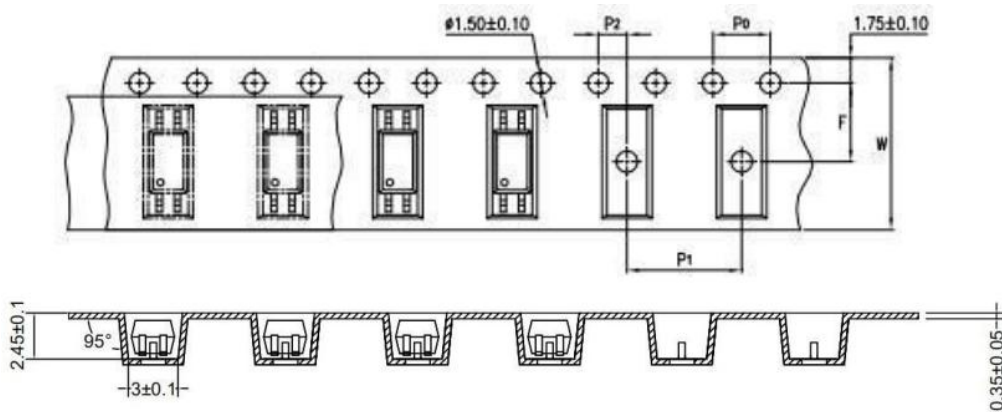

| type | Symbol | Dimensions: mm (in.) |
|-----------|--------|----------------------|
| bandwidth | W | 12±0.3 (0.47) |
| pitch | P0 | 4±0.1 (0.15) |
| pitch | F | 5.5±0.1 (0.217) |
| | P2 | 2±0.1 (0.079) |
| interval | P1 | 8±0.1 (0.315) |

| | |
|--------------------|--------|
| Encapsulation type | TP/TP1 |
| Quantity (pieces) | 3000 |

12. Package Dimension

(1) package dimension

| Packing Information | |
|-----------------------------|---------------|
| Packing type | Reel type |
| Tape Width | 12mm |
| Qty per Reel | 3,000pcs |
| Small box (inner) Dimension | 345*345*45mm |
| Large box (Outer) Dimension | 480x360x360mm |
| Max qty per small box | 6,000pcs |
| Max qty per large box | 60,000pcs |

(2)Packing Label Sample



Note:

1. P/N :Contents with "Order Information" in the specification.
2. LOT NO : The production lot.
3. BATCH : The Electrical rank.
4. Quantity :Packaging quantity.
5. Product Data :Date of manufacture.

13. Reliability Test

| NO. | ITEMS | Reliability Testing | | | | |
|-----|----------------------------|---------------------|--|--------------|-----------------------|-------------|
| | | QTY. (Pcs) | Condition | Process | Device | Standard |
| 1 | RSH 耐焊接热 | 22 | 260±5℃ | 10s/3 次 | 锡炉 | JESD22-A106 |
| 2 | HTSL 高温存储 | 77 | 125℃ | 168 hrs | 高温烤箱 测试仪 | JESD22-A103 |
| | | | | 500 hrs | | |
| | | | | 1000 hrs | | |
| 3 | LTSL 低温存储 | 77 | -55℃ | 168 hrs | 低温箱 测试仪 | JESD22-A119 |
| | | | | 500 hrs | | |
| | | | | 1000 hrs | | |
| 4 | TC 温度循环 | 77 | H:125℃ 15min ∫ 5min L:-55℃ 15min | 300 cycle | 冷热冲击机 | JESD22-A104 |
| 5 | TS 温度冲击 | 77 | H:100℃ 5min ∫ 15s L:-40℃ 5min | 300 cycle | 冷热冲击机 | JESD22-A106 |
| 6 | HTOL 高温操作 | 77 | 110℃ IF=10mA Vce=5V | 168 hrs | 高温烤箱 测试仪、老 化电路板 | JESD22-A108 |
| | | | | 500 hrs | | |
| | | | | 1000 hrs | | |
| 7 | ESD-HBM 人体模式 | 22 | ≥8KV 1Cycle | 1次 | ESD静电测 试仪 | JESD22-A114 |
| 8 | SD 可焊性 | 22 | Pb-free 245±5℃ | 5S/1次 | 锡炉 | JESD22-B102 |
| 9 | HTRB 高温反向偏压 | 77 | HTRB @125℃ Vce=80v | 168 hrs | 高温烤箱 , 测试仪 | JESD22-A103 |
| | | | | 500 hrs | | |
| | | | | 1000 hrs | | |
| 10 | H3TRB 温湿度反向偏 压, 寿命试验 | 77 | H3TRB 85℃,85%RH Vce=80v | 168 hrs | 恒温恒湿 机, 测试仪 | JESD22-A101 |
| | | | | 500 hrs | | |
| | | | | 1000 hrs | | |
| 11 | Autoclave 压力锅 | 77 | Ta=121 ℃,100%RH,2atm | 96hrs | 压力锅 | JESD22-A102 |

14. Temperature Profile Of Soldering

(1) IR Reflow soldering (JEDEC-STD-020C compliant)

One time soldering reflow is recommended within the condition of temperature and time profile shown below. Do not solder more than three times.

| Profile item | Conditions |
|--------------------------------------|----------------|
| Preheat | |
| - Temperature Min (T Smin) | 150°C |
| - Temperature Max (T Smax) | 200°C |
| - Time (min to max) (ts) | 90±30 sec |
| Soldering zone | |
| - Temperature (TL) | 217°C |
| - Time (t L) | 60 sec |
| Peak Temperature | 260°C |
| Peak Temperature time | 20 sec |
| Ramp-up rate | 3°C / sec max. |
| Ramp-down rate from peak temperature | 3~6°C / sec |
| Reflow times | ≤3 |

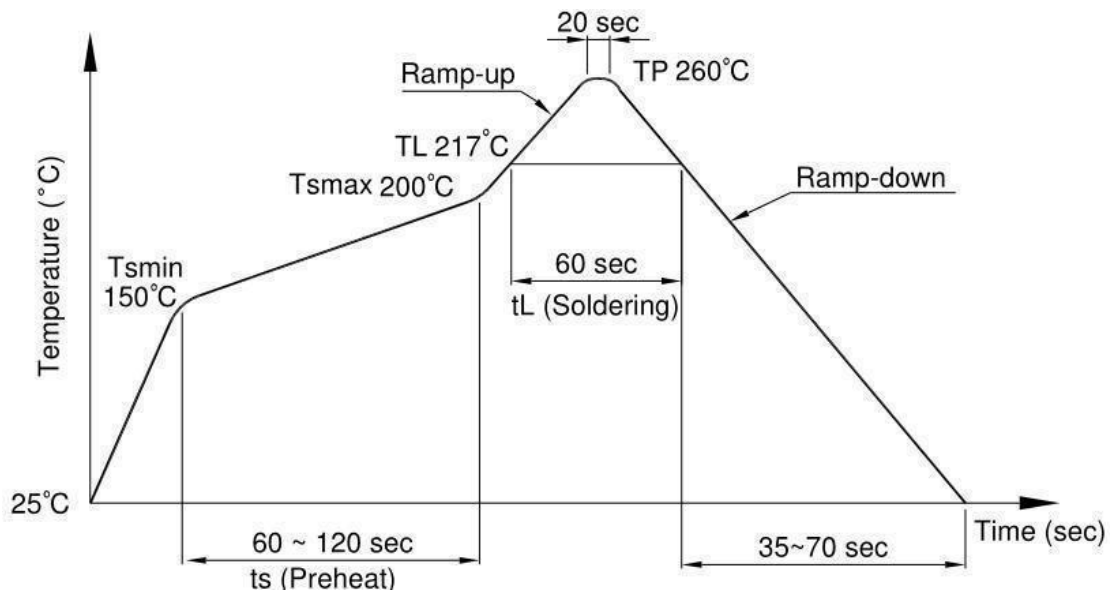

(2) Wave soldering (JEDEC22A111 compliant)

One time soldering is recommended within the condition of temperature.

| | |
|---------------------|--------------|
| Temperature | 260+0/-5°C |
| Time | 10 sec |
| Preheat temperature | 25 to 140°C |
| Preheat time | 30 to 80 sec |

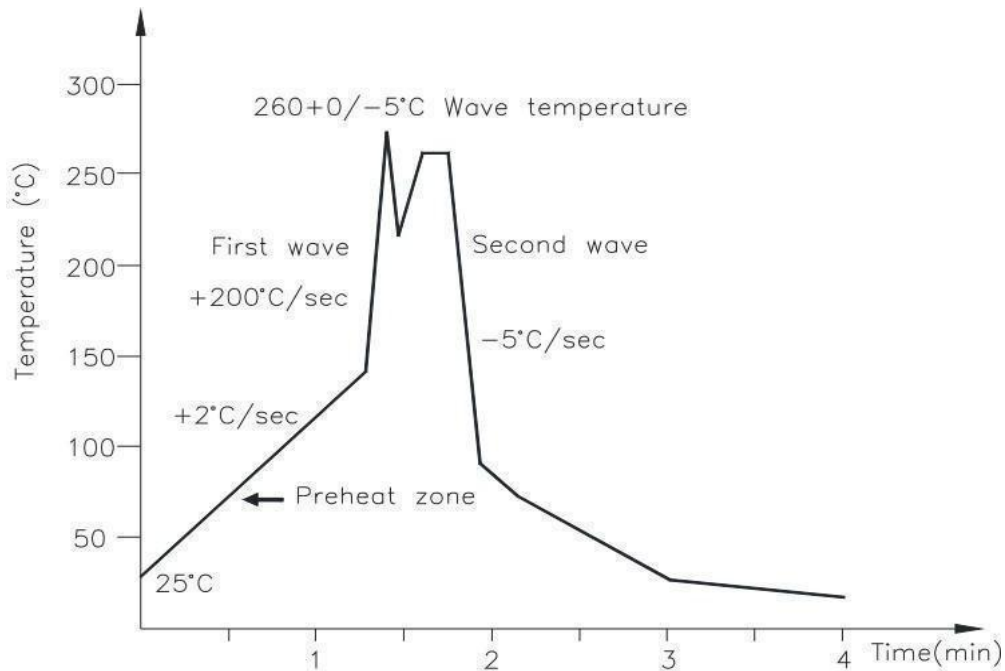

(3) Hand soldering by soldering iron

Allow single lead soldering in every single process. One time soldering is recommended.

| | |
|-------------|------------|
| Temperature | 380+0/-5°C |
| Time | 3 sec max |

15. Characteristics Curve

Figure 1. Collector Power Dissipation vs. Ambient Temperature

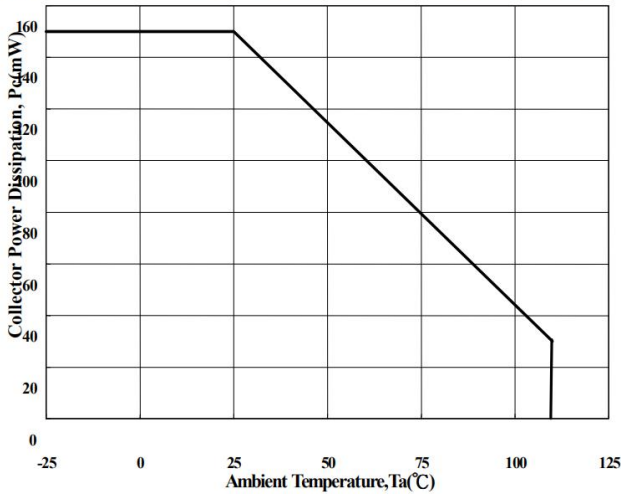

Figure 2. Forward Current vs. Ambient Temperature

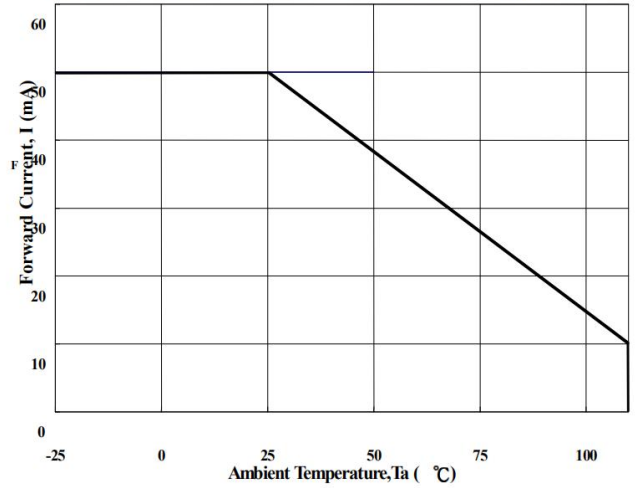

Figure 3. Forward Current vs. Forward Voltage

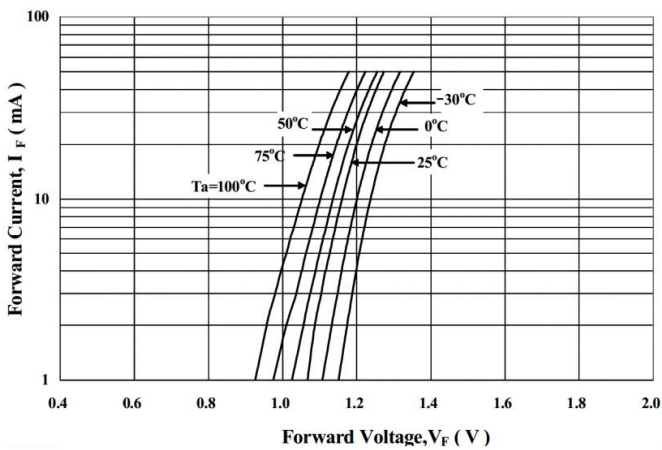

Figure 4. Forward Voltage Temperature Coefficient vs. Forward Current

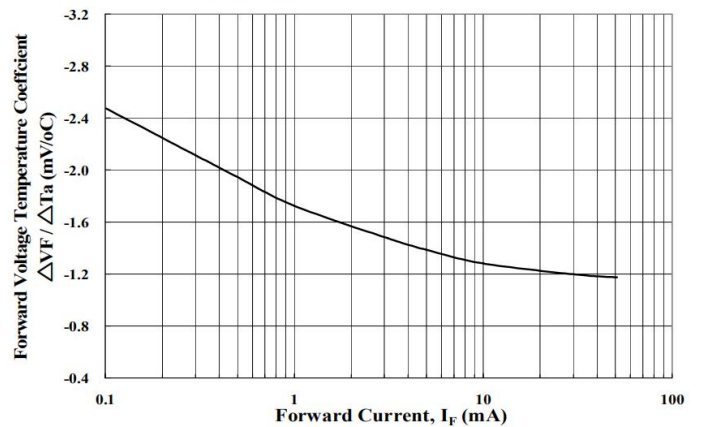

Figure 5. Pulse Forward Current vs. Duty Cycle Ratio

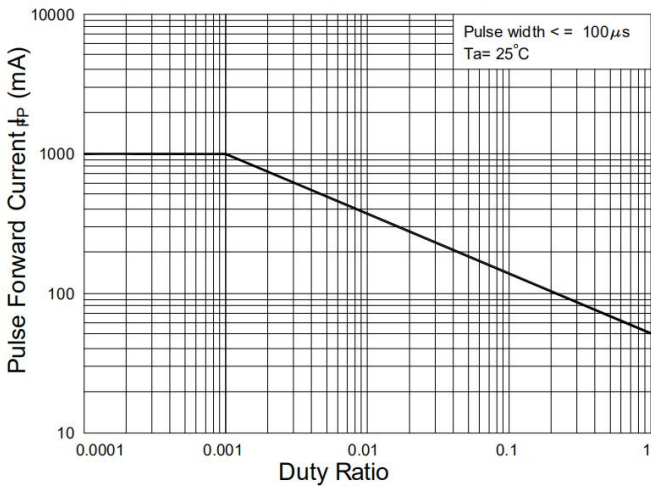

Figure 6. Pulse Forward Current vs. Pulse Forward Voltage

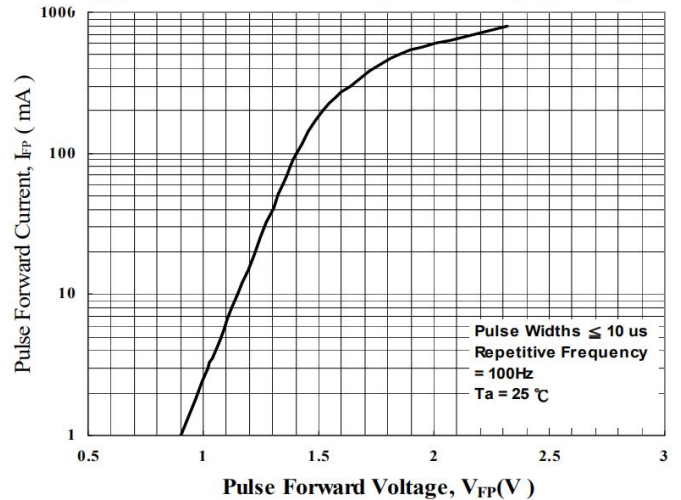

Figure 7. Collector-Emitter Saturation Voltage vs. Forward

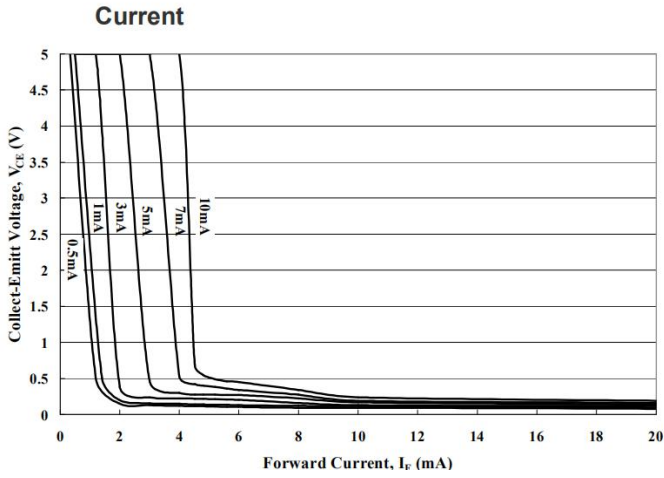

Figure 8. Collector Current vs. Collector-Emitter

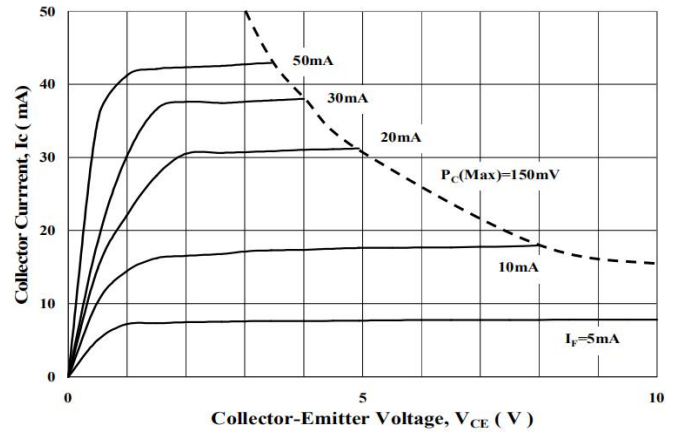

Figure 9. Collector Current vs. Small Collector-Emitter

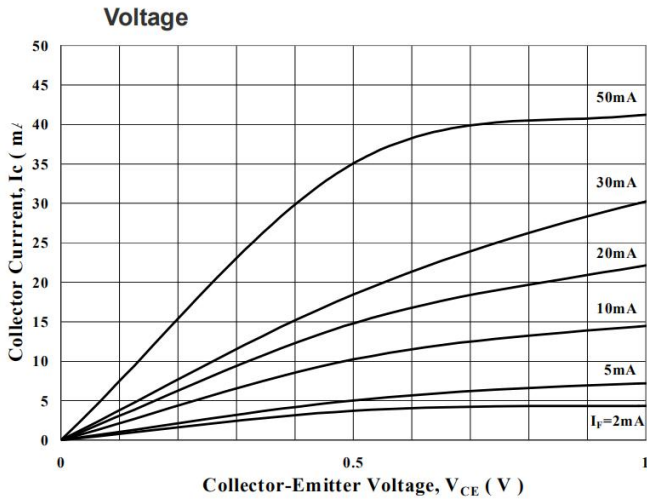

Figure 10. Normalized CTR vs. Forward Current

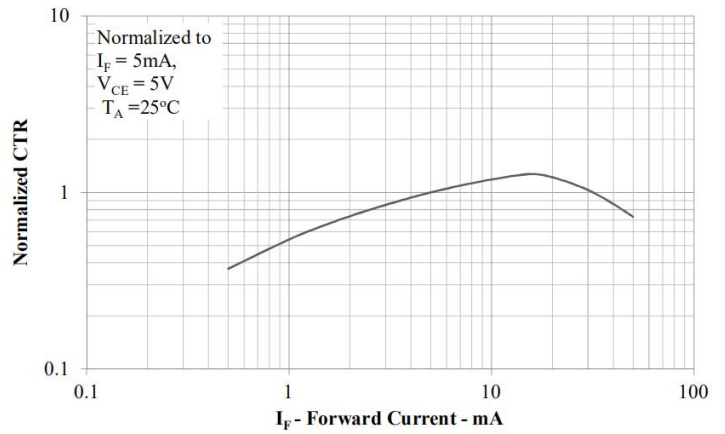

Figure 11. Collector Dark Current vs. Ambient Temperature

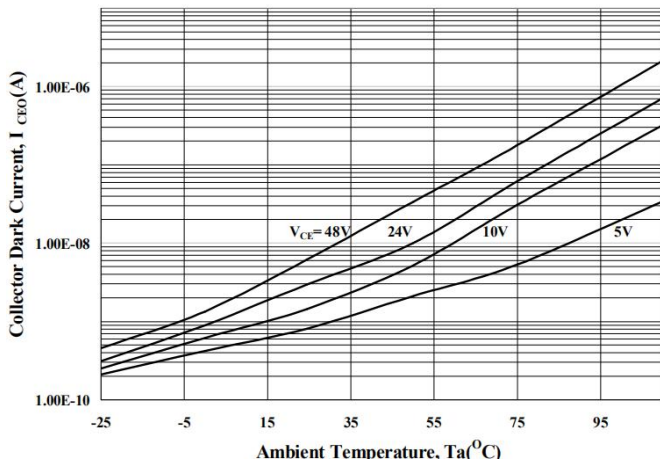

Figure 12. Current Transfer Ratio vs. Forward

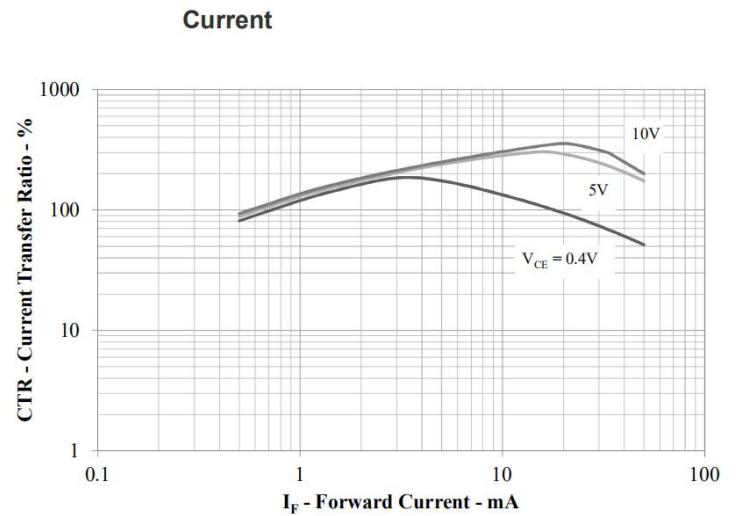

Figure 13. Normalized CTR vs. Ambient Temperature

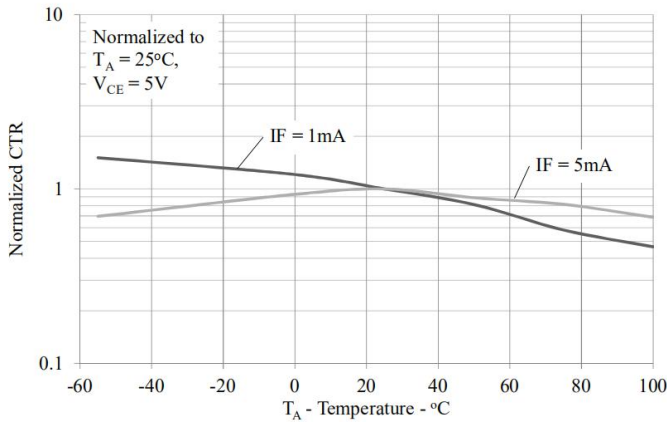

Figure 14. Collector-Emitter Saturation Voltage vs. Ambient Temperature

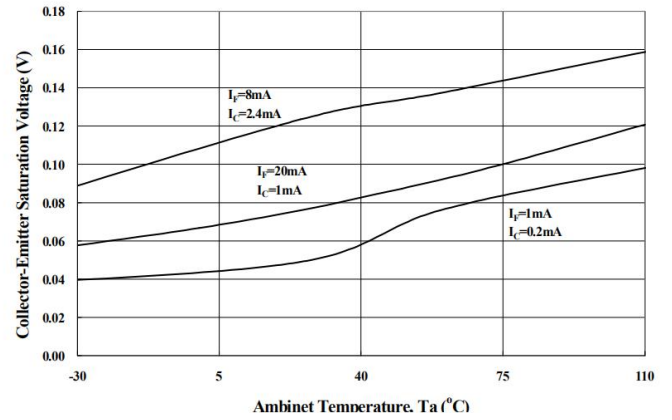

Figure 15. Collector Current vs. Ambient Temperature

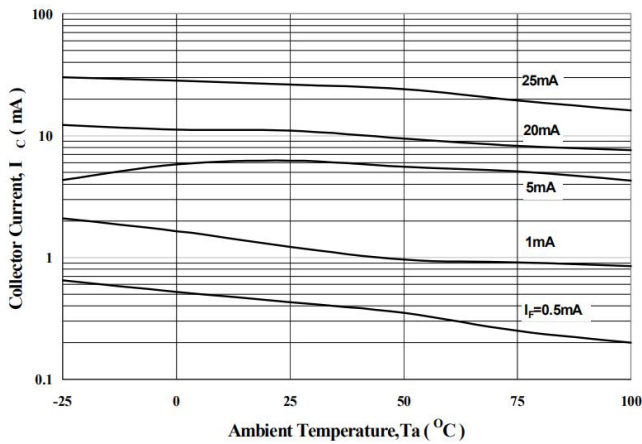

Figure 16. Switching Time vs. Load Resistance

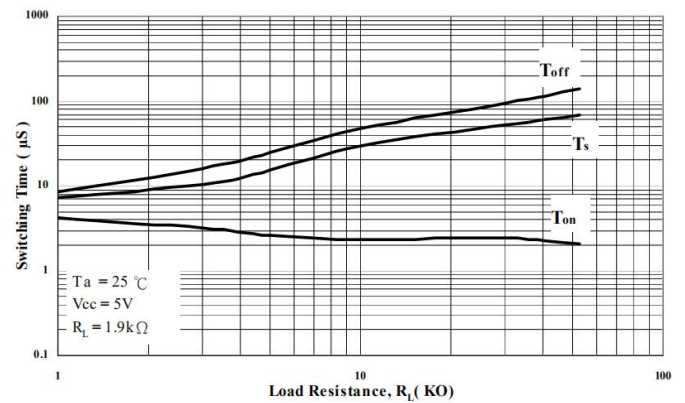

Figure 17. Switching Time vs. Ambient Temperature

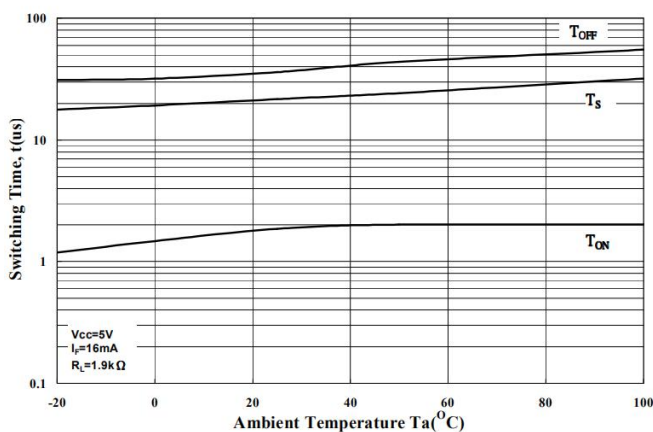
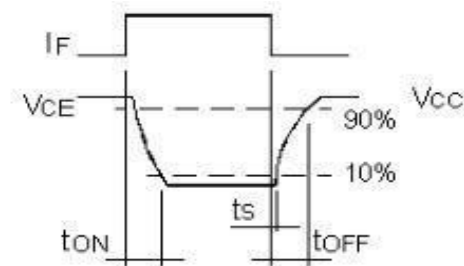
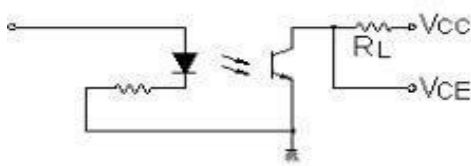
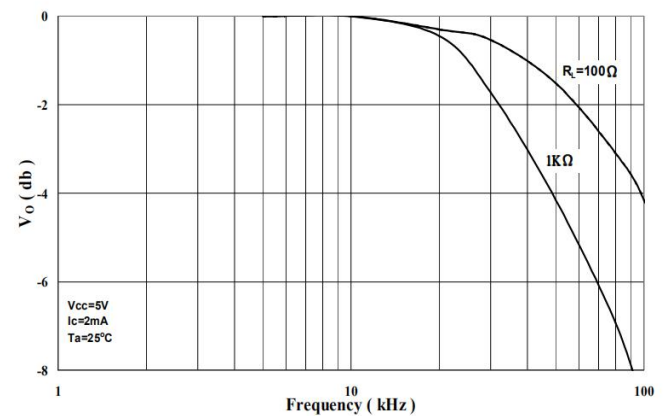

Figure 18. Frequency Response



单击下面可查看定价，库存，交付和生命周期等信息

[>>ORIENT\(奥伦德\)](#)