

# SFH 309 FA

## Radial T1

Silicon NPN Phototransistor



## Applications

- Electronic Equipment
- Highbay Industrial
- Industrial Automation (Machine controls, Light barriers, Vision controls)
- White Goods

## Features:

- Package: clear silicone
- ESD: 2 kV acc. to ANSI/ESDA/JEDEC JS-001 (HBM, Class 2)
- Spectral range of sensitivity: (typ) 730 ... 1120 nm
- High photosensitivity
- High linearity
- Available in groups

## Ordering Information

Type	Photocurrent $V_{CE} = 5 \text{ V}; \lambda = 950 \text{ nm}; E_e = 0.5 \text{ mW/cm}^2$ $I_{PCE}$	Ordering Code
SFH 309 FA-4	1000 ... 2000 $\mu\text{A}$	Q62702P0178
SFH 309 FA-5	1600 ... 3200 $\mu\text{A}$	Q62702P0180
SFH 309 FA	400 ... 5000 $\mu\text{A}$	Q62702P0941
SFH 309 FA-3/4	630 ... 2000 $\mu\text{A}$	Q62702P3590
SFH 309 FA-4/5	1000 ... 3200 $\mu\text{A}$	Q62702P3591
SFH 309 FA-5/6	1600 ... 5000 $\mu\text{A}$	Q62702P5199

Only one bin within one packing unit (variation less than 2:1)

## Maximum Ratings

$T_A = 25\text{ °C}$

Parameter	Symbol		Values
Operating temperature	$T_{op}$	min. max.	-40 °C 100 °C
Storage temperature	$T_{stg}$	min. max.	-40 °C 100 °C
Collector-emitter voltage	$V_{CE}$	max.	35 V
Collector current	$I_C$	max.	15 mA
Collector surge current $\tau \leq 10\ \mu\text{s}$	$I_{CS}$	max.	75 mA
Total power dissipation	$P_{tot}$	max.	165 mW
ESD withstand voltage acc. to ANSI/ESDA/JEDEC JS-001 (HBM, Class 2)	$V_{ESD}$	max.	2 kV

## Characteristics

$T_A = 25\text{ °C}$

Parameter	Symbol		Values
Wavelength of max sensitivity	$\lambda_{S\text{max}}$	typ.	900 nm
Spectral range of sensitivity	$\lambda_{10\%}$	typ.	730 ... 1120 nm
Chip dimensions	L x W	typ.	0.45 x 0.45 mm x mm
Radiant sensitive area $\varnothing = 220\text{ }\mu\text{m}$	A	typ.	0.038 mm <sup>2</sup>
Distance chip front to case surface	H	max. min.	2.8 2.4
Half angle	$\varphi$	typ.	12 °
Dark current $V_{CE} = 20\text{ V}; E = 0$	$I_{CE0}$	typ. max.	1 nA 50 nA
Rise time $I_C = 1\text{ mA}; V_{CE} = 5\text{ V}; R_L = 1\text{ k}\Omega$	$t_r$	typ.	7 $\mu\text{s}$
Fall time $I_C = 1\text{ mA}; V_{CE} = 5\text{ V}; R_L = 1\text{ k}\Omega$	$t_f$	typ.	7 $\mu\text{s}$
Collector-emitter saturation voltage <sup>1)</sup> $I_C = I_{PCE,min} \times 0.3; E_e = 0.5\text{ mW/cm}^2$	$V_{CEsat}$	typ.	200 mV
Capacitance $V_{CE} = 0\text{ V}; f = 1\text{ MHz}; E = 0$	$C_{CE}$	typ.	5 pF
Thermal resistance junction ambient real	$R_{thJA}$	max.	450 K / W

## Grouping

$T_A = 25\text{ °C}$

Group	Photocurrent	Photocurrent
	$V_{CE} = 5\text{ V}; \lambda = 950\text{ nm}; E_e = 0.5\text{ mW/cm}^2$ min. $I_{PCE}$	$V_{CE} = 5\text{ V}; \lambda = 950\text{ nm}; E_e = 0.5\text{ mW/cm}^2$ max. $I_{PCE}$
2	400 $\mu\text{A}$	800 $\mu\text{A}$
3	630 $\mu\text{A}$	1250 $\mu\text{A}$
4	1000 $\mu\text{A}$	2000 $\mu\text{A}$
5	1600 $\mu\text{A}$	3200 $\mu\text{A}$
6	2500 $\mu\text{A}$	5000 $\mu\text{A}$

## Relative Spectral Sensitivity <sup>2), 3)</sup>

$S_{rel} = f(\lambda)$

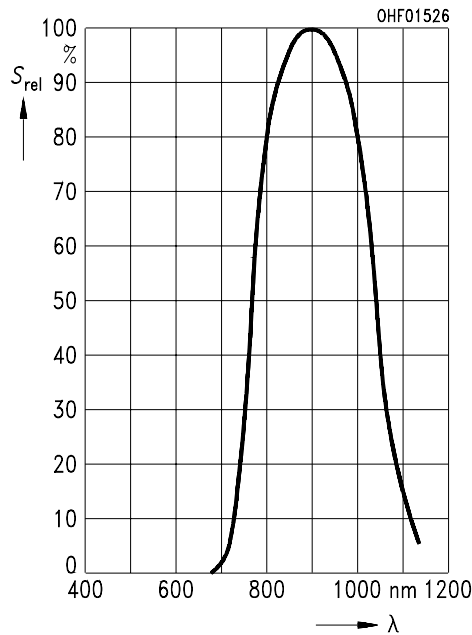

### Directional Characteristics <sup>2), 3)</sup>

$$S_{rel} = f(\varphi)$$

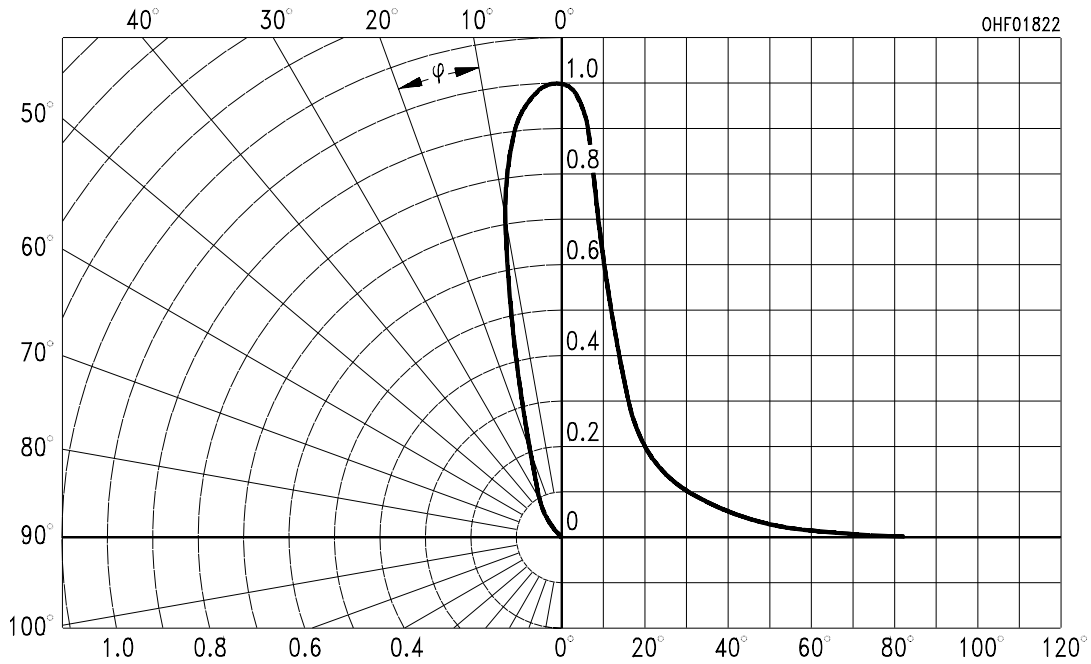

### Photocurrent <sup>2), 3)</sup>

$$I_{PCE} = f(E_e); V_{CE} = 5 V$$

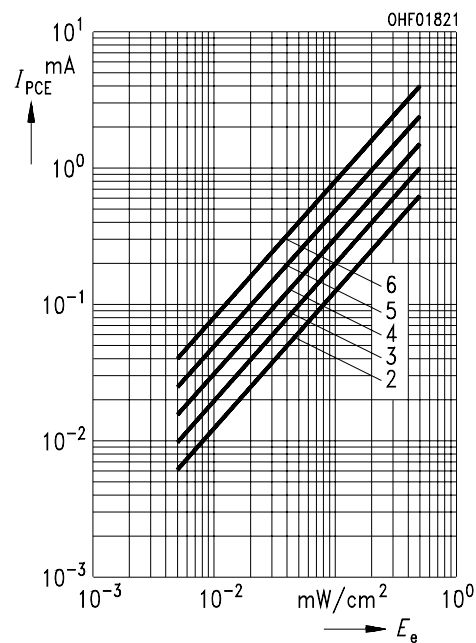

### Photocurrent <sup>2), 3)</sup>

$$I_{PCE} = f(V_{CE}), E_e = \text{Parameter}$$

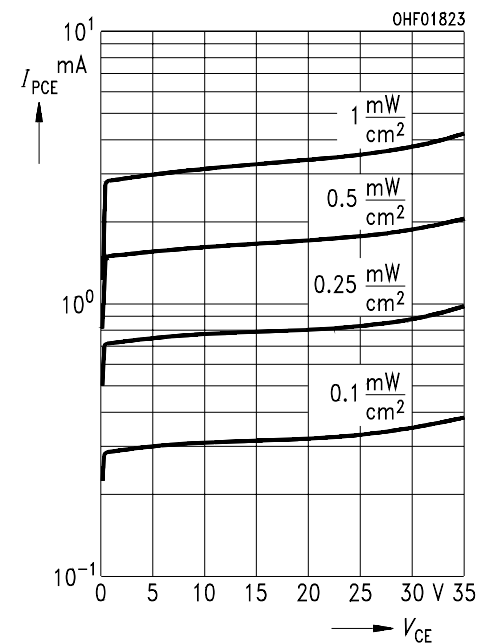

### Dark Current <sup>2), 3)</sup>

$$I_{CE0} = f(V_{CE}); E = 0;$$

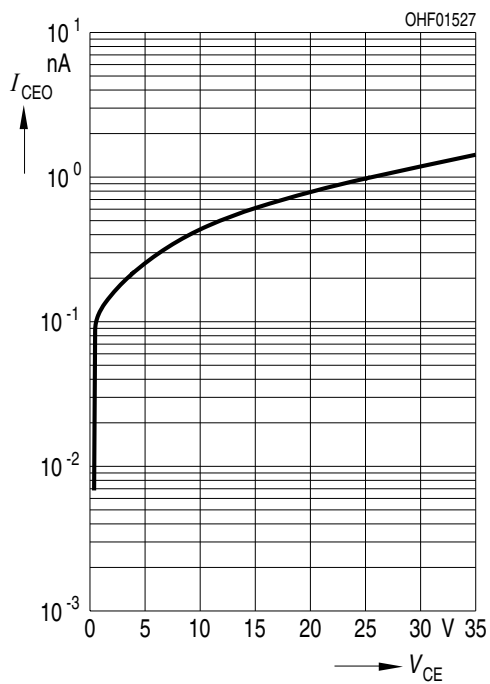

### Collector-Emitter Capacitance <sup>2), 3)</sup>

$$C_{CE} = f(V_{CE}); f = 1 \text{ MHz}; E = 0;$$

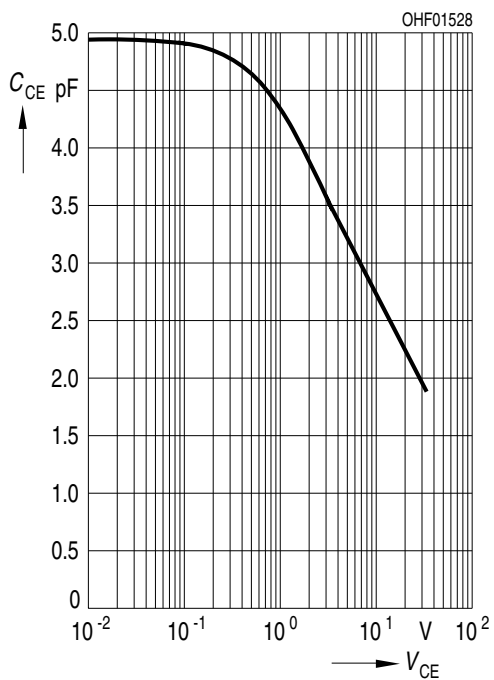

### Dark Current <sup>2)</sup>

$$I_{CE0} = f(T_A); V_{CE} = 20 \text{ V}; E = 0$$

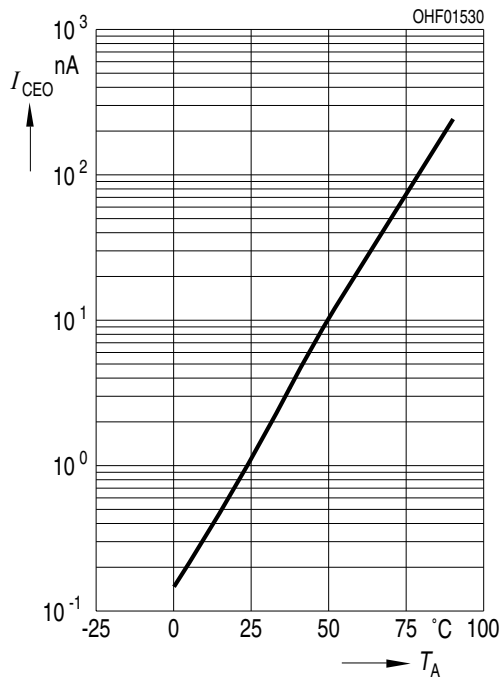

### Photocurrent <sup>2)</sup>

$$I_{PCE,rel} = f(T_A); V_{CE} = 5 \text{ V}$$

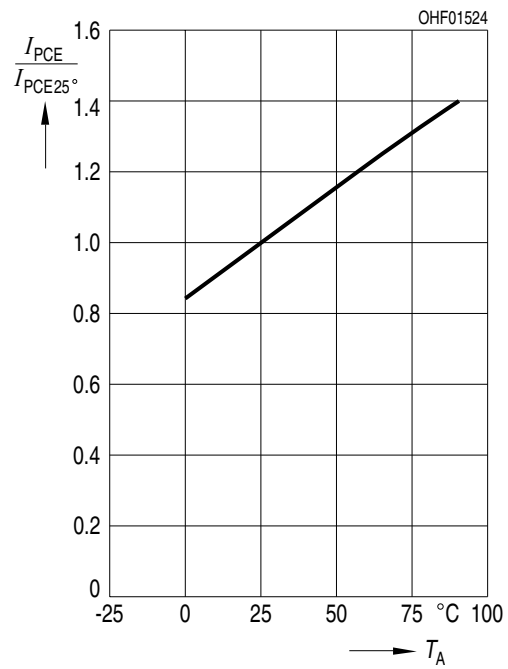

### Power Consumption

$$P_{tot} = f(T_A)$$

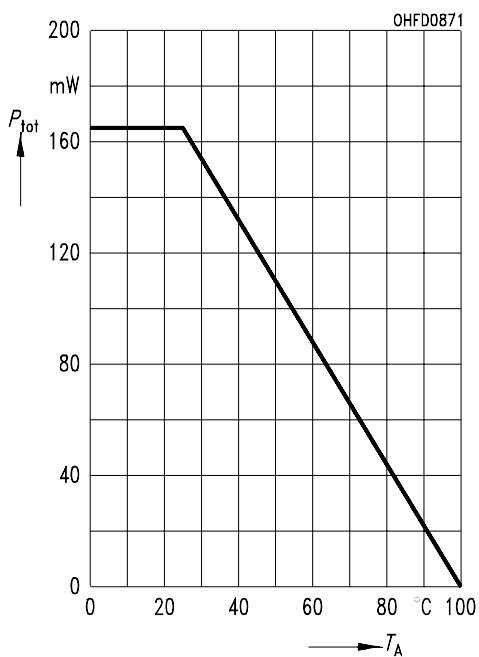

Dimensional Drawing <sup>4)</sup>

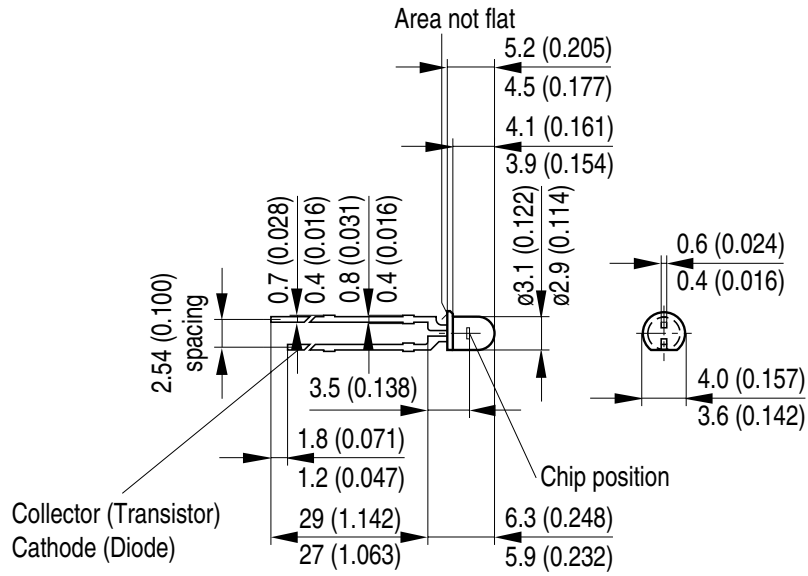

Approximate Weight: 178.0 mg

Package marking: Collector



### Recommended Solder Pad <sup>4)</sup>

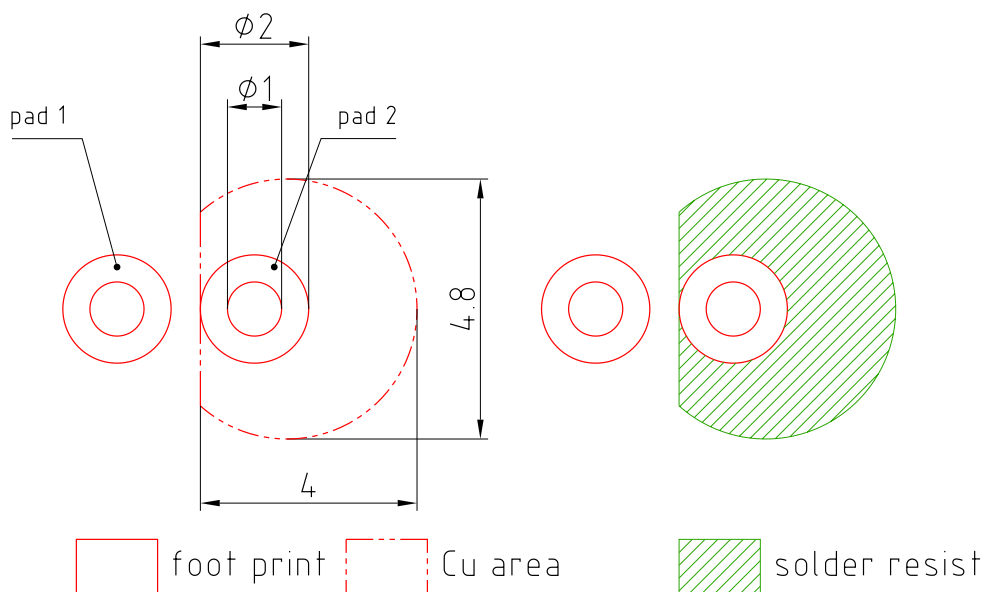

E062.3010.188-01

Pad 1: emitter

## TTW Soldering

IEC-61760-1 TTW

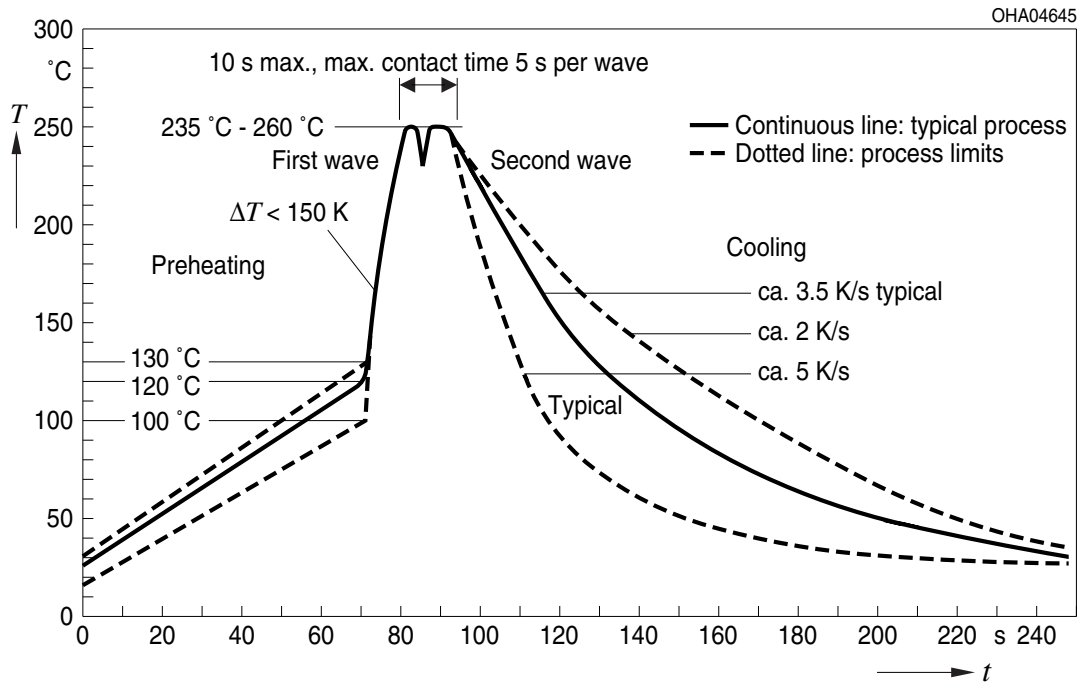

## Notes

The evaluation of eye safety occurs according to the standard IEC 62471:2006 (photo biological safety of lamps and lamp systems). Within the risk grouping system of this IEC standard, the LED specified in this data sheet falls into the class **exempt group (exposure time 10000 s)**. Under real circumstances (for exposure time, conditions of the eye pupils, observation distance), it is assumed that no endangerment to the eye exists from these devices. As a matter of principle, however, it should be mentioned that intense light sources have a high secondary exposure potential due to their blinding effect. When looking at bright light sources (e.g. headlights), temporary reduction in visual acuity and afterimages can occur, leading to irritation, annoyance, visual impairment, and even accidents, depending on the situation.

Packing information is available on the internet (online product catalog).

For further application related informations please visit [www.osram-os.com/appnotes](http://www.osram-os.com/appnotes)

## Disclaimer

### Disclaimer

Language english will prevail in case of any discrepancies or deviations between the two language wordings.

### Attention please!

The information describes the type of component and shall not be considered as assured characteristics. Terms of delivery and rights to change design reserved. Due to technical requirements components may contain dangerous substances.

For information on the types in question please contact our Sales Organization.

If printed or downloaded, please find the latest version in the OSRAM OS Webside.

### Packing

Please use the recycling operators known to you. We can also help you – get in touch with your nearest sales office.

By agreement we will take packing material back, if it is sorted. You must bear the costs of transport. For packing material that is returned to us unsorted or which we are not obliged to accept, we shall have to invoice you for any costs incurred.

### Product safety devices/applications or medical devices/applications

OSRAM OS components are not developed, constructed or tested for the application as safety relevant component or for the application in medical devices.

In case Buyer – or Customer supplied by Buyer– considers using OSRAM OS components in product safety devices/applications or medical devices/applications, Buyer and/or Customer has to inform the local sales partner of OSRAM OS immediately and OSRAM OS and Buyer and /or Customer will analyze and coordinate the customer-specific request between OSRAM OS and Buyer and/or Customer.

## Glossary

- 1) **IPCEmin:**  $I_{\text{PCEmin}}$  is the min. photocurrent of the specified group.
- 2) **Typical Values:** Due to the special conditions of the manufacturing processes of LED, the typical data or calculated correlations of technical parameters can only reflect statistical figures. These do not necessarily correspond to the actual parameters of each single product, which could differ from the typical data and calculated correlations or the typical characteristic line. If requested, e.g. because of technical improvements, these typ. data will be changed without any further notice.
- 3) **Testing temperature:**  $T_A = 25^\circ\text{C}$
- 4) **Tolerance of Measure:** Unless otherwise noted in drawing, tolerances are specified with  $\pm 0.1$  and dimensions are specified in mm.

Published by OSRAM Opto Semiconductors GmbH EU RoHS and China RoHS compliant product  
Leibnizstraße 4, D-93055 Regensburg  
www.osram-os.com © All Rights Reserved.



此产品符合欧盟 RoHS 指令的要求；  
按照中国的相关法规和标准，不含有毒有害物质或元素。

单击下面可查看定价，库存，交付和生命周期等信息

[>>OSRAM\(欧司朗光电半导体\)](#)