

SFH 4550

Radial T1 3/4

Infrared Emitter (850 nm)



Applications

- Electronic Equipment
- Highbay Industrial
- Industrial Automation (Machine Controls, Light Barriers, Vision Controls)
- Safety and Security, CCTV
- Smoke/Dust/Particle Sensing
- White Goods

Features:

- Package: clear epoxy
- ESD: 2 kV acc. to ANSI/ESDA/JEDEC JS-001 (HBM, Class 2)
- High Power Infrared LED
- Narrow half angle ($\pm 3^\circ$)
- Very high radiant intensity
- UL version E9548 available (details & test conditions on request)

Ordering Information

Type	Radiant intensity ¹⁾²⁾ $I_F = 100 \text{ mA}; t_p = 20 \text{ ms}$ I_e	Radiant intensity ¹⁾ typ. $I_F = 100 \text{ mA}; t_p = 20 \text{ ms}$ I_e	Ordering Code
SFH 4550-EWFW	710 ... 1800 mW/sr	1,100 mW/sr	Q65110A7758
SFH 4550	710 ... 2800 mW/sr	1,100 mW/sr	Q65110A1772
SFH 4550 E9548	710 ... 2800 mW/sr	1,100 mW/sr	Q65110A8097

Maximum Ratings

$T_A = 25\text{ °C}$

Parameter	Symbol		Values
Operating temperature	T_{op}	min. max.	-40 °C 100 °C
Storage temperature	T_{stg}	min. max.	-40 °C 100 °C
Forward current	I_F	max.	100 mA
Forward current pulsed $t_p \leq 400\ \mu\text{s}$; $D \leq 0.005$	$I_{F\ pulse}$	max.	1 A
Reverse voltage ³⁾	V_R	max.	5 V
Power consumption	P_{tot}	max.	180 mW
ESD withstand voltage acc. to ANSI/ESDA/JEDEC JS-001 (HBM, Class 2)	V_{ESD}	max.	2 kV

Characteristics

$I_F = 100 \text{ mA}$; $t_p = 20 \text{ ms}$; $T_A = 25 \text{ °C}$

Parameter	Symbol		Values
Peak wavelength	λ_{peak}	typ.	860 nm
Centroid wavelength	$\lambda_{\text{centroid}}$	typ.	850 nm
Spectral bandwidth at 50% $I_{\text{rel,max}}$ (FWHM)	$\Delta\lambda$	typ.	30 nm
Half angle	φ	typ.	3 °
Dimensions of active chip area	L x W	typ.	0.3 x 0.3 mm x mm
Rise time (10% / 90%) $I_F = 100 \text{ mA}$; $R_L = 50 \text{ }\Omega$	t_r	typ.	12 ns
Fall time (10% / 90%) $I_F = 100 \text{ mA}$; $R_L = 50 \text{ }\Omega$	t_f	typ.	12 ns
Forward voltage ⁴⁾	V_F	typ. max.	1.5 V 1.7 V
Forward voltage ⁴⁾ $I_F = 1 \text{ A}$; $t_p = 100 \text{ }\mu\text{s}$	V_F	typ. max.	2.4 V 2.9 V
Reverse current ³⁾ $V_R = 5 \text{ V}$	I_R	typ. max.	0.01 μA 10 μA
Radiant intensity ¹⁾ $I_F = 1 \text{ A}$; $t_p = 25 \text{ }\mu\text{s}$	I_e	typ.	8500 mW/sr
Total radiant flux ⁵⁾	Φ_e	typ.	70 mW
Temperature coefficient of voltage	TC_V	typ.	-0.7 mV / K
Temperature coefficient of brightness	TC_I	typ.	-0.5 % / K
Temperature coefficient of wavelength	TC_λ	typ.	0.3 nm / K
Thermal resistance junction ambient real ⁶⁾	R_{thJA}	max.	450 K / W

Brightness Groups

$T_A = 25\text{ }^\circ\text{C}$

Group	Radiant intensity ¹⁾²⁾ $I_F = 100\text{ mA}; t_p = 20\text{ ms}$ min. I_e	Radiant intensity ¹⁾²⁾ $I_F = 100\text{ mA}; t_p = 20\text{ ms}$ max. I_e
	EW	710 mW/sr
FW	1120 mW/sr	1800 mW/sr
GW	1800 mW/sr	2800 mW/sr

Only one group in one packing unit (variation lower 2:1).

Relative Spectral Emission ^{7), 8)}

$I_{e,rel} = f(\lambda); I_F = 100\text{ mA}; t_p = 20\text{ ms}$

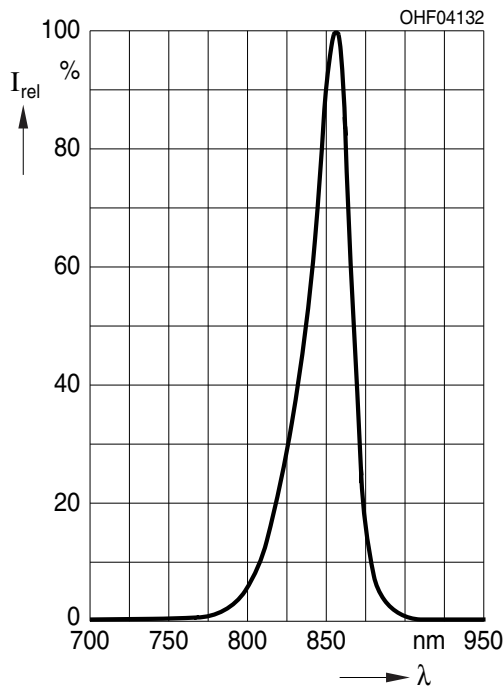

Radiation Characteristics (7), 8)

$I_{e,rel} = f(\varphi)$

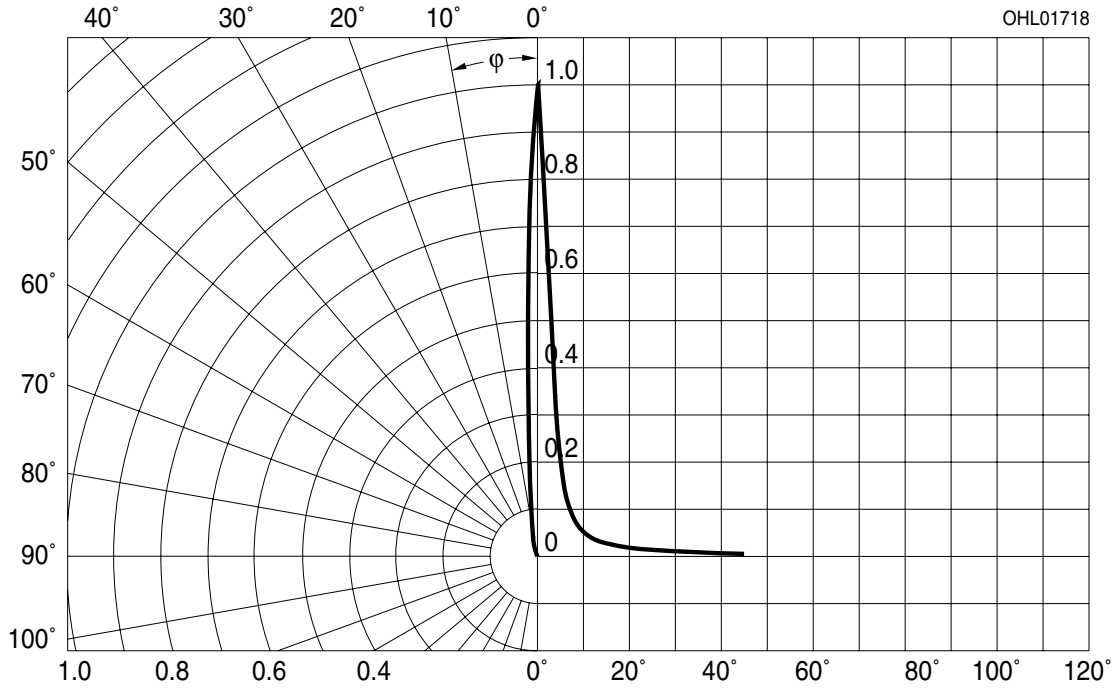

Forward current (7), 8)

$I_F = f(V_F)$; single pulse; $t_p = 100 \mu s$

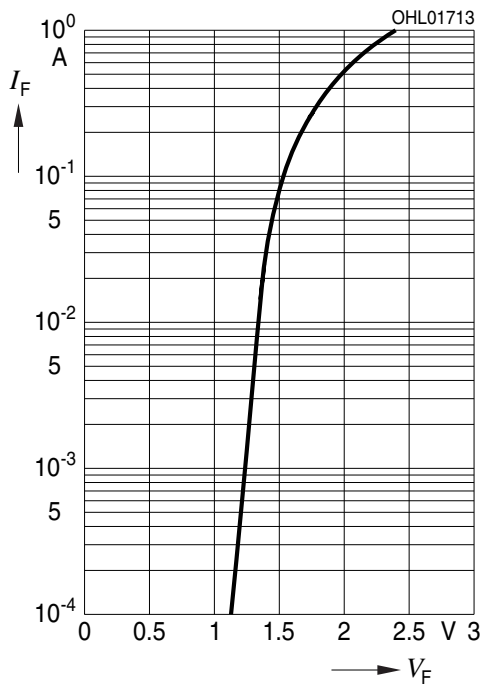

Radiant Intensity (7), 8)

$I_e/I_e(100mA) = f(I_F)$; single pulse; $t_p = 25 \mu s$

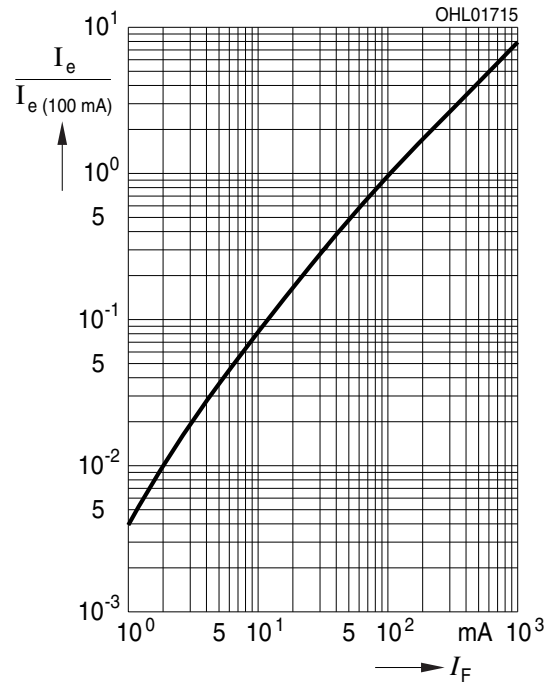

Max. Permissible Forward Current

$I_{F,max} = f(T_A)$; $R_{th,ja} = 450K / W$

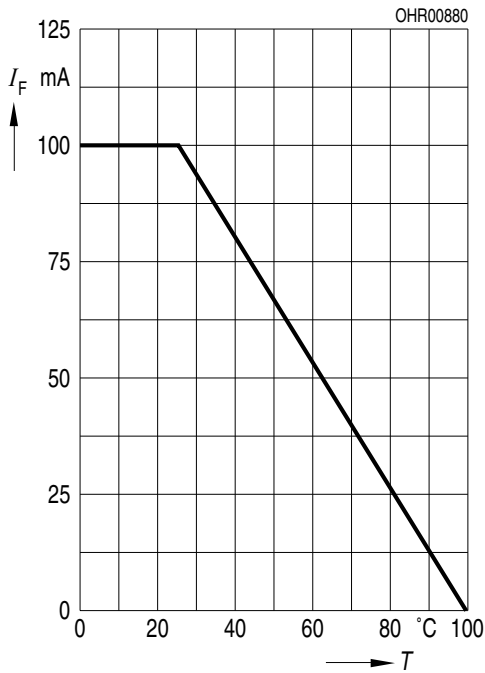

Permissible Pulse Handling Capability

$I_F = f(t_p)$; duty cycle $D = \text{parameter}$; $T_A = 25^\circ C$

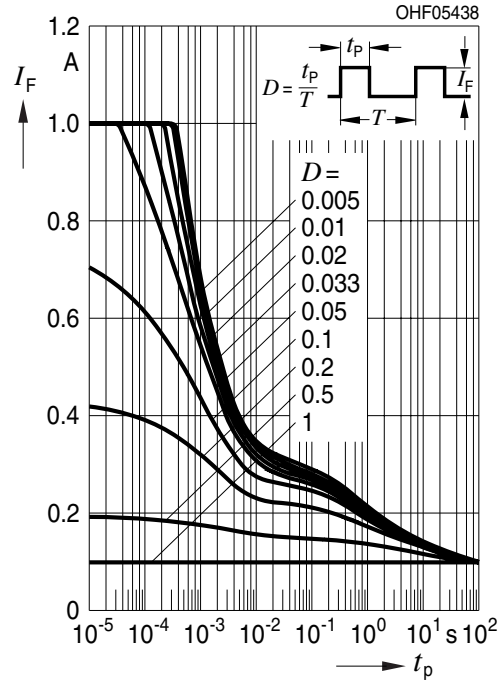

Permissible Pulse Handling Capability

$I_F = f(t_p)$; duty cycle $D = \text{parameter}$; $T_A = 85^\circ C$

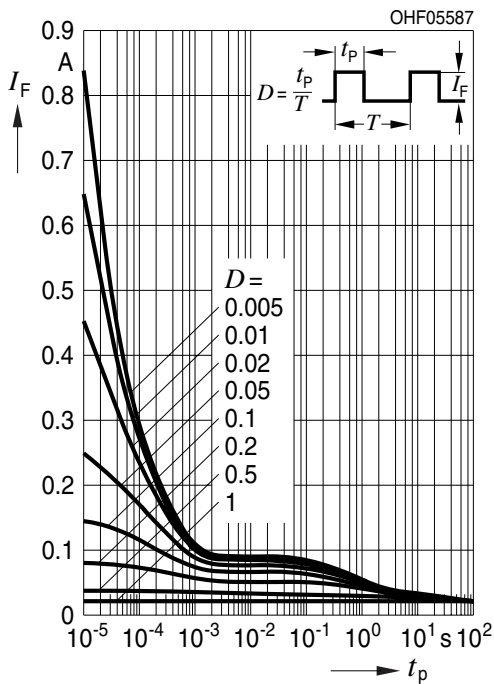

Dimensional Drawing ⁹⁾

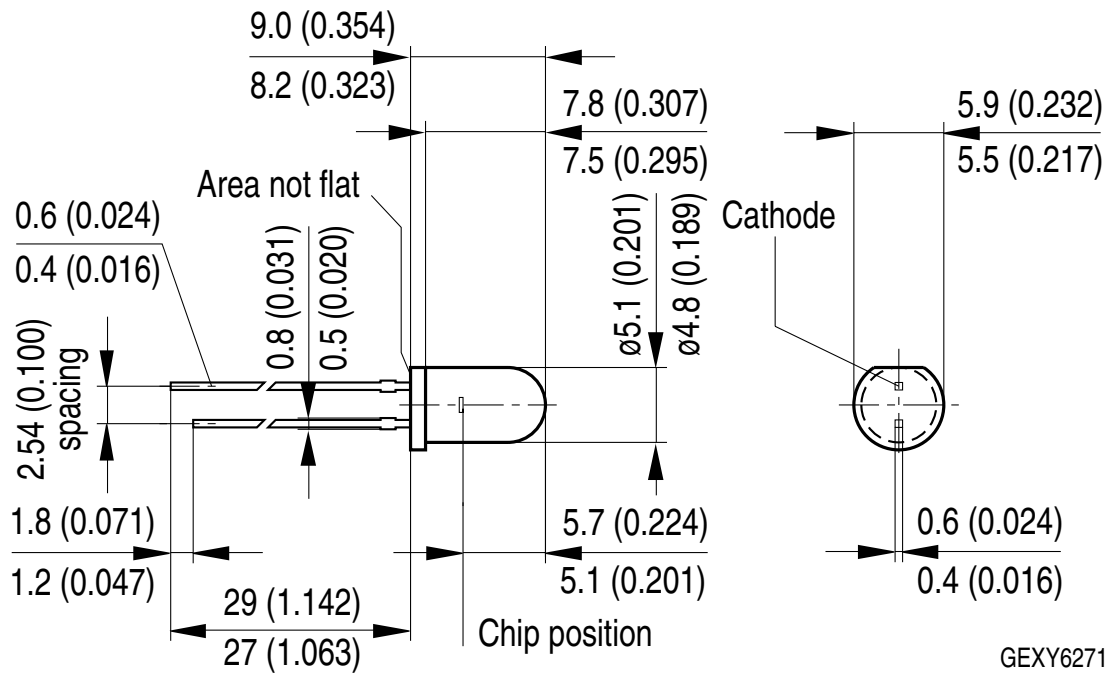

GEXY6271

Further Information:

Approximate Weight: 329.0 mg

Package marking: Cathode

Recommended Solder Pad ⁹⁾

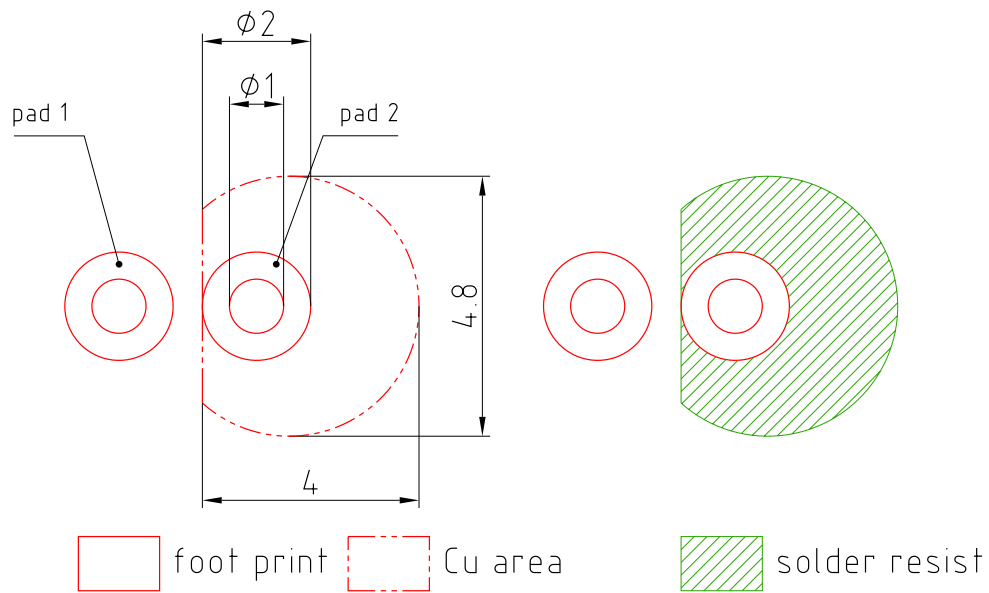

E062.3010.188-01

Pad 1: cathode

TTW Soldering

IEC-61760-1 TTW

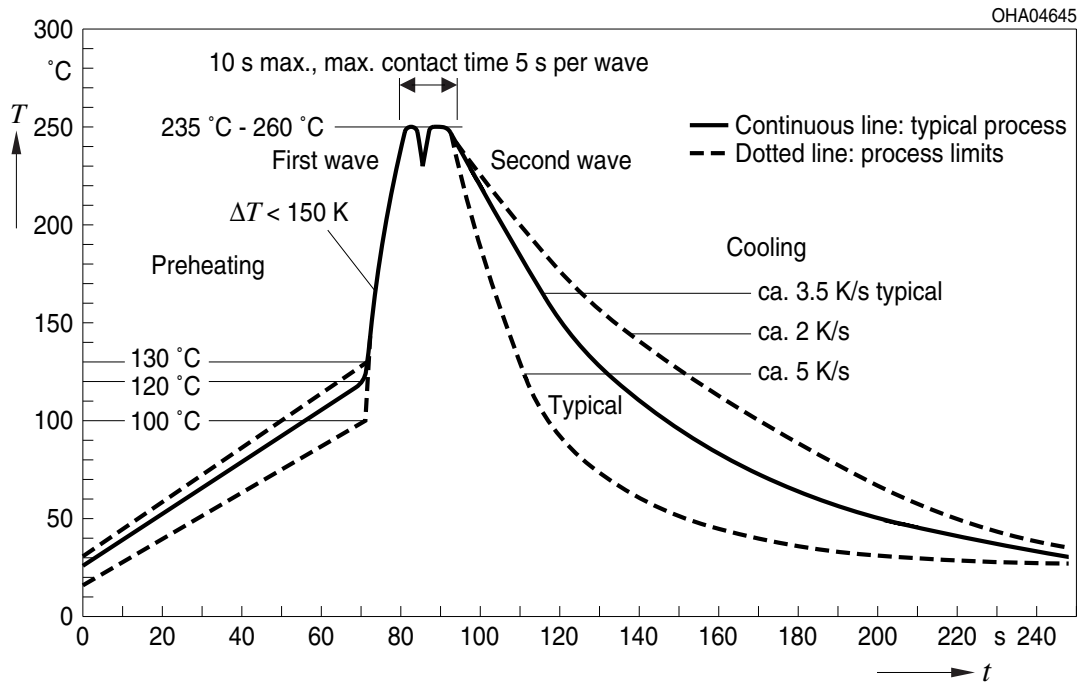

Notes

The evaluation of eye safety occurs according to the standard IEC 62471:2006 (photo biological safety of lamps and lamp systems). Within the risk grouping system of this IEC standard, the device specified in this data sheet fall into the class **exempt group (exposure time 10000 s)**. Under real circumstances (for exposure time, conditions of the eye pupils, observation distance), it is assumed that no endangerment to the eye exists from these devices. As a matter of principle, however, it should be mentioned that intense light sources have a high secondary exposure potential due to their blinding effect. When looking at bright light sources (e.g. headlights), temporary reduction in visual acuity and afterimages can occur, leading to irritation, annoyance, visual impairment, and even accidents, depending on the situation.

Subcomponents of this device contain, in addition to other substances, metal filled materials including silver. Metal filled materials can be affected by environments that contain traces of aggressive substances. Therefore, we recommend that customers minimize device exposure to aggressive substances during storage, production, and use. Devices that showed visible discoloration when tested using the described tests above did show no performance deviations within failure limits during the stated test duration. Respective failure limits are described in the IEC60810.

Packing information is available on the internet (online product catalog).

For further application related information please visit www.osram-os.com/appnotes

Disclaimer

Attention please!

The information describes the type of component and shall not be considered as assured characteristics. Terms of delivery and rights to change design reserved. Due to technical requirements components may contain dangerous substances.

For information on the types in question please contact our Sales Organization.

If printed or downloaded, please find the latest version on the OSRAM OS website.

Packing

Please use the recycling operators known to you. We can also help you – get in touch with your nearest sales office. By agreement we will take packing material back, if it is sorted. You must bear the costs of transport. For packing material that is returned to us unsorted or which we are not obliged to accept, we shall have to invoice you for any costs incurred.

Product and functional safety devices/applications or medical devices/applications

OSRAM OS components are not developed, constructed or tested for the application as safety relevant component or for the application in medical devices.

OSRAM OS products are not qualified at module and system level for such application.

In case buyer – or customer supplied by buyer – considers using OSRAM OS components in product safety devices/applications or medical devices/applications, buyer and/or customer has to inform the local sales partner of OSRAM OS immediately and OSRAM OS and buyer and /or customer will analyze and coordinate the customer-specific request between OSRAM OS and buyer and/or customer.

Glossary

- 1) **Radiant intensity:** Measured at a solid angle of $\Omega = 0.001$ sr
- 2) **Brightness:** The brightness values are measured with a tolerance of $\pm 11\%$.
- 3) **Reverse Operation:** This product is intended to be operated applying a forward current within the specified range. Applying any continuous reverse bias or forward bias below the voltage range of light emission shall be avoided because it may cause migration which can change the electro-optical characteristics or damage the LED.
- 4) **Forward Voltage:** The forward voltages are measured with a tolerance of ± 0.1 V.
- 5) **Total radiant flux:** Measured with integrating sphere.
- 6) **Thermal resistance:** junction - ambient, mounted on PC-board (FR4), padsize 16 mm² each
- 7) **Typical Values:** Due to the special conditions of the manufacturing processes of semiconductor devices, the typical data or calculated correlations of technical parameters can only reflect statistical figures. These do not necessarily correspond to the actual parameters of each single product, which could differ from the typical data and calculated correlations or the typical characteristic line. If requested, e.g. because of technical improvements, these typ. data will be changed without any further notice.
- 8) **Testing temperature:** TA = 25°C (unless otherwise specified)
- 9) **Tolerance of Measure:** Unless otherwise noted in drawing, tolerances are specified with ± 0.1 and dimensions are specified in mm.

Revision History

Version	Date	Change
1.7	2020-03-10	New Layout Ordering Information Characteristics
1.8	2021-11-18	Features

Published by OSRAM Opto Semiconductors GmbH EU RoHS and China RoHS compliant product
Leibnizstraße 4, D-93055 Regensburg
www.osram-os.com © All Rights Reserved.



此产品符合欧盟 RoHS 指令的要求；
按照中国的相关法规和标准，不含有毒有害物质或元素。

单击下面可查看定价，库存，交付和生命周期等信息

[>>OSRAM\(欧司朗光电半导体\)](#)