

SFH 309

Radial T1

Silicon NPN Phototransistor



Applications

- Electronic Equipment
- Highbay Industrial
- Industrial Automation (Machine controls, Light barriers, Vision controls)
- White Goods

Features:

- Package: clear epoxy
- ESD: 2 kV acc. to ANSI/ESDA/JEDEC JS-001 (HBM, Class 2)
- Spectral range of sensitivity: (typ) 380 ... 1150 nm
- High photosensitivity
- High linearity
- Available in groups

Ordering Information

| Type | Photocurrent $V_{CE} = 5 \text{ V}; \lambda = 950 \text{ nm}; E_e = 0.5 \text{ mW/cm}^2$ I_{PCE} | Ordering Code |
|-------------|--|---------------|
| SFH 309 | 400 ... 5000 μA | Q62702P0859 |
| SFH 309-4 | 1000 ... 2000 μA | Q62702P0998 |
| SFH 309-5 | 1600 ... 3200 μA | Q62702P0999 |
| SFH 309-3/4 | 630 ... 2000 μA | Q62702P3592 |
| SFH 309-4/5 | 1000 ... 3200 μA | Q62702P3593 |
| SFH 309-5/6 | 1600 ... 5000 μA | Q62702P3594 |

Only one bin within one packing (variation less than 2:1)

Maximum Ratings

$T_A = 25\text{ °C}$

| Parameter | Symbol | | Values |
|--|-----------|--------------|------------------|
| Operating Temperature | T_{op} | min. max. | -40 °C 100 °C |
| Storage Temperature | T_{stg} | min. max. | -40 °C 100 °C |
| Collector-emitter voltage | V_{CE} | max. | 35 V |
| Collector current | I_C | max. | 15 mA |
| Collector surge current $\tau \leq 10\ \mu\text{s}$ | I_{CS} | max. | 75 mA |
| Total power dissipation | P_{tot} | max. | 165 mW |
| ESD withstand voltage acc. to ANSI/ESDA/JEDEC JS-001 (HBM, Class 2) | V_{ESD} | max. | 2 kV |

Characteristics

$T_A = 25\text{ °C}$

| Parameter | Symbol | | Values |
|---|--------------------------|--------------|-----------------------|
| Wavelength of max sensitivity | $\lambda_{S\text{ max}}$ | typ. | 860 nm |
| Spectral range of sensitivity | $\lambda_{10\%}$ | typ. | 380 ... 1150 nm |
| Chip dimensions | L x W | typ. | 0.45 x 0.45 mm x mm |
| Radiant sensitive area $\varnothing = 220\text{ }\mu\text{m}$ | A | typ. | 0.038 mm ² |
| Distance chip front to case surface | H | max. min. | 2.8 2.4 |
| Half angle | φ | typ. | 12 ° |
| Photocurrent $V_{CE} = 5\text{ V}$; Std. Light A; $E_v = 1000\text{ lx}$ | I_{PCE} | typ. | 4500 μA |
| Dark current $V_{CE} = 20\text{ V}$; $E = 0$ | I_{CE0} | typ. max. | 1 nA 50 nA |
| Rise time $I_C = 1\text{ mA}$; $V_{CC} = 5\text{ V}$; $R_L = 1\text{ k}\Omega$ | t_r | typ. | 7 μs |
| Fall time $I_C = 1\text{ mA}$; $V_{CC} = 5\text{ V}$; $R_L = 1\text{ k}\Omega$ | t_f | typ. | 7 μs |
| Collector-emitter saturation voltage ¹⁾ $I_C = I_{PCE, \text{min}} \times 0.3$; $E_e = 0.5\text{ mW/cm}^2$ | $V_{CE\text{ sat}}$ | typ. | 200 mV |
| Capacitance $V_{CE} = 0\text{ V}$; $f = 1\text{ MHz}$; $E = 0$ | C_{CE} | typ. | 5 pF |
| Thermal resistance junction ambient real | R_{thJA} | max. | 450 K / W |

Grouping

$T_A = 25\text{ °C}$

| Group | Photocurrent | Photocurrent |
|-------|---|---|
| | $V_{CE} = 5\text{ V}; \lambda = 950\text{ nm}; E_e = 0.5\text{ mW/cm}^2$ min. I_{PCE} | $V_{CE} = 5\text{ V}; \lambda = 950\text{ nm}; E_e = 0.5\text{ mW/cm}^2$ max. I_{PCE} |
| 2 | 400 μA | 800 μA |
| 3 | 630 μA | 1250 μA |
| 4 | 1000 μA | 2000 μA |
| 5 | 1600 μA | 3200 μA |
| 6 | 2500 μA | 5000 μA |

Relative Spectral Sensitivity ^{2), 3)}

$S_{rel} = f(\lambda)$

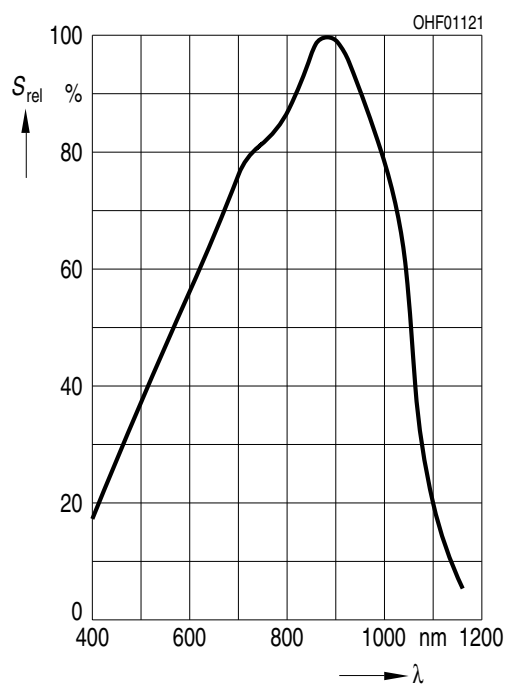

Directional Characteristics 2), 3)

$S_{rel} = f(\varphi)$

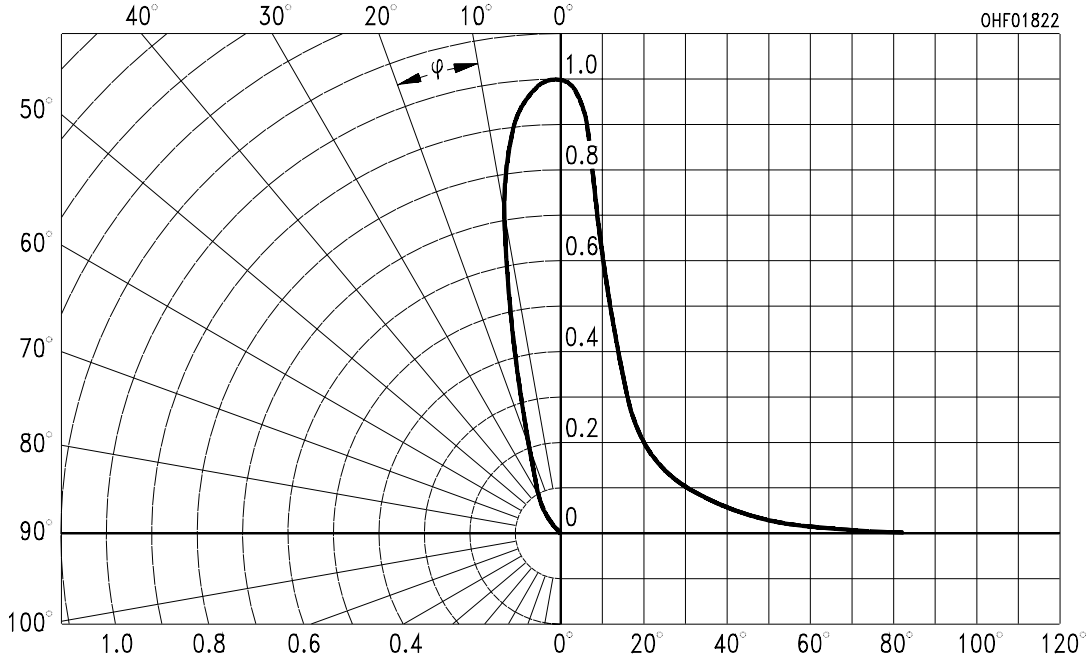

Photocurrent 2), 3)

$I_{PCE} = f(E_e); V_{CE} = 5 V$

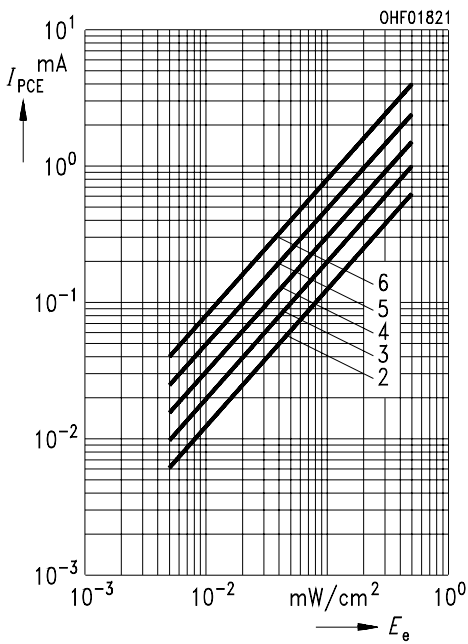

Photocurrent 2), 3)

$I_{PCE} = f(V_{CE}), E_e = \text{Parameter}$

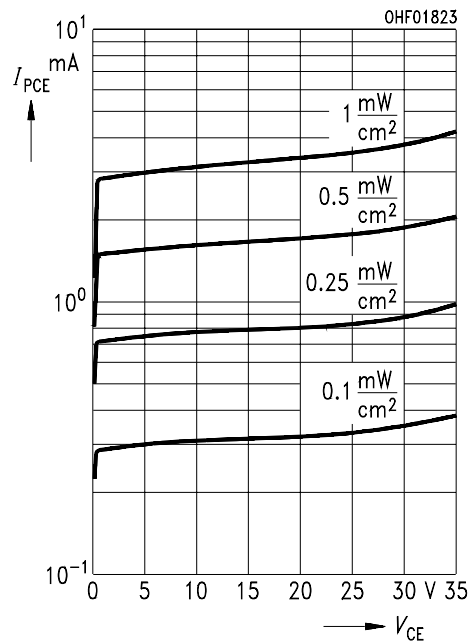

Dark Current ^{2), 3)}

$$I_{CE0} = f(V_{CE}); E = 0;$$

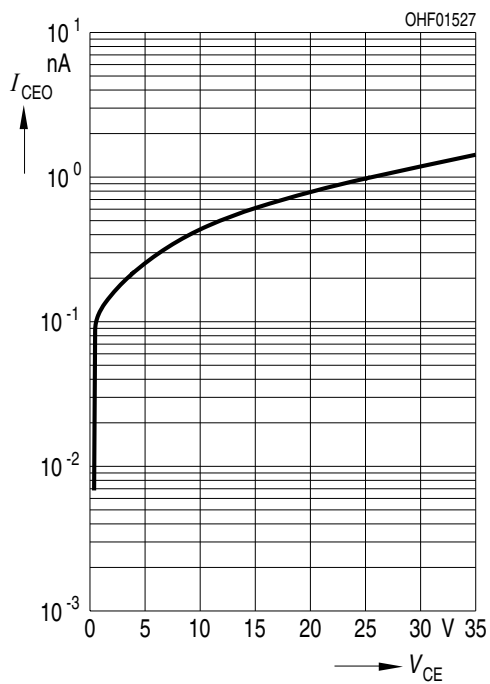

Collector-Emitter Capacitance ^{2), 3)}

$$C_{CE} = f(V_{CE}); f = 1 \text{ MHz}; E = 0;$$

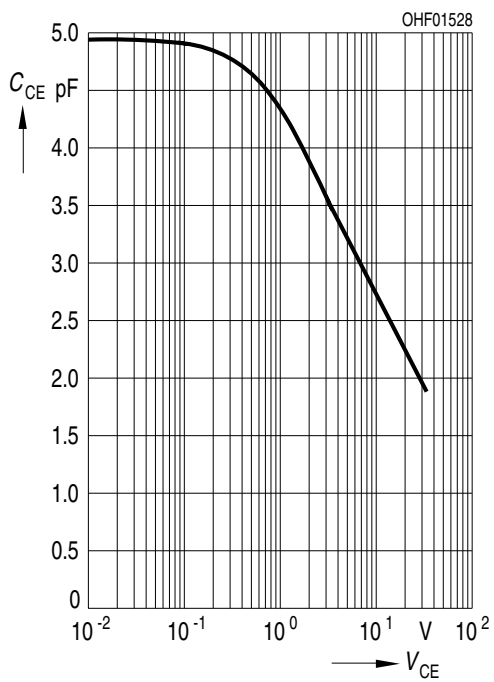

Dark Current ²⁾

$$I_{CE0} = f(T_A); V_{CE} = 20 \text{ V}; E = 0$$

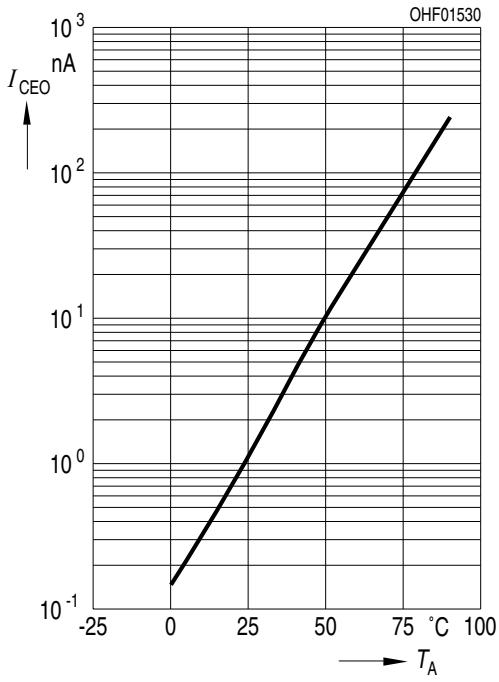

Photocurrent ²⁾

$$I_{PCE,rel} = f(T_A); V_{CE} = 5 \text{ V}$$

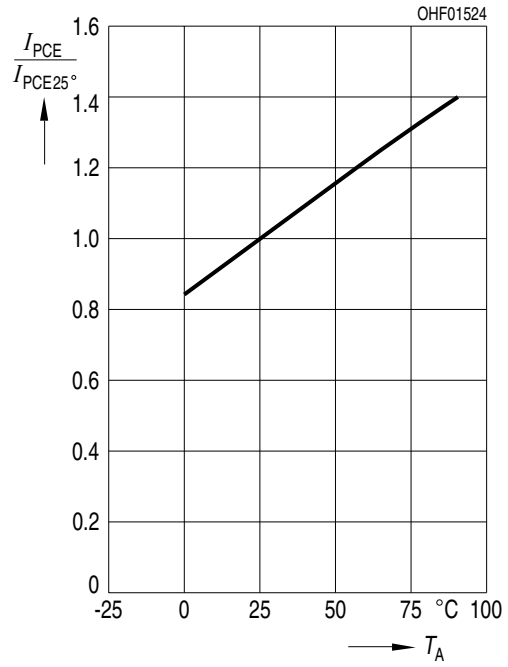

Power Consumption

$$P_{tot} = f(T_A)$$

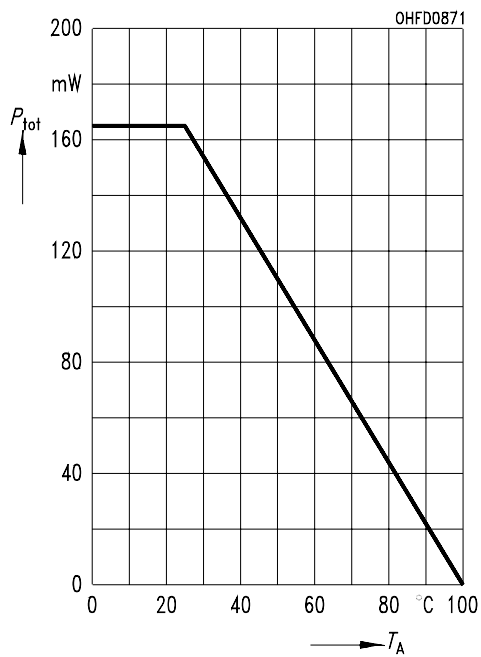

Dimensional Drawing ⁴⁾

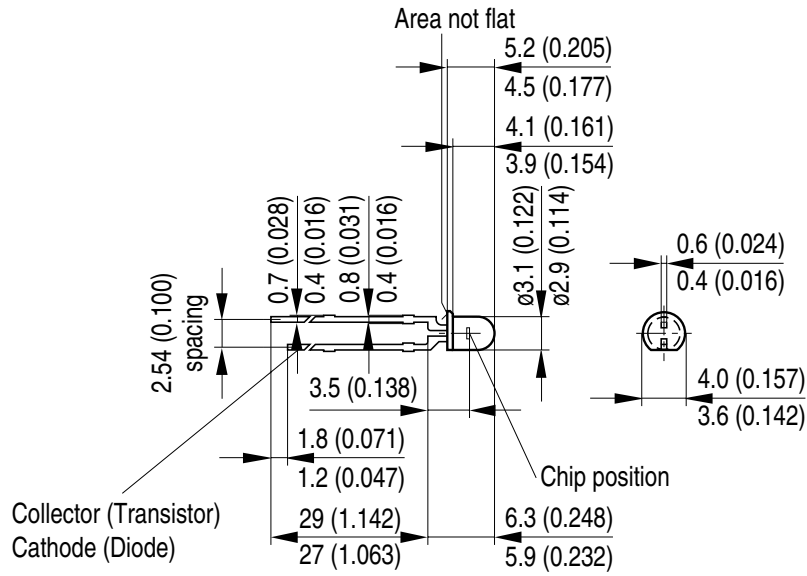

GEOY6653

Approximate Weight: 178.0 mg

Package marking: Collector

Recommended Solder Pad ⁴⁾

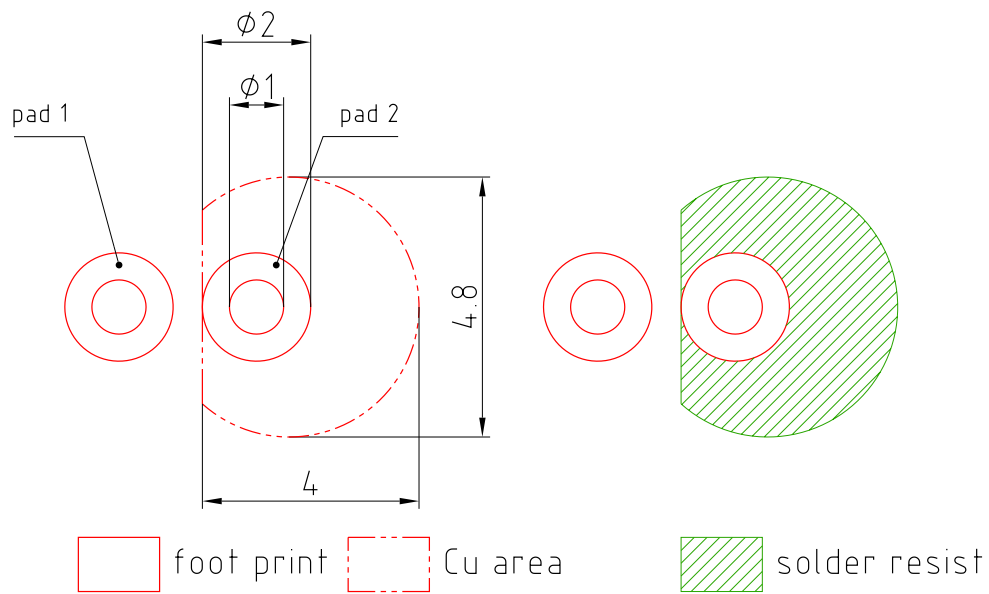

E062.3010.188-01

Pad 1: emitter

TTW Soldering

IEC-61760-1 TTW

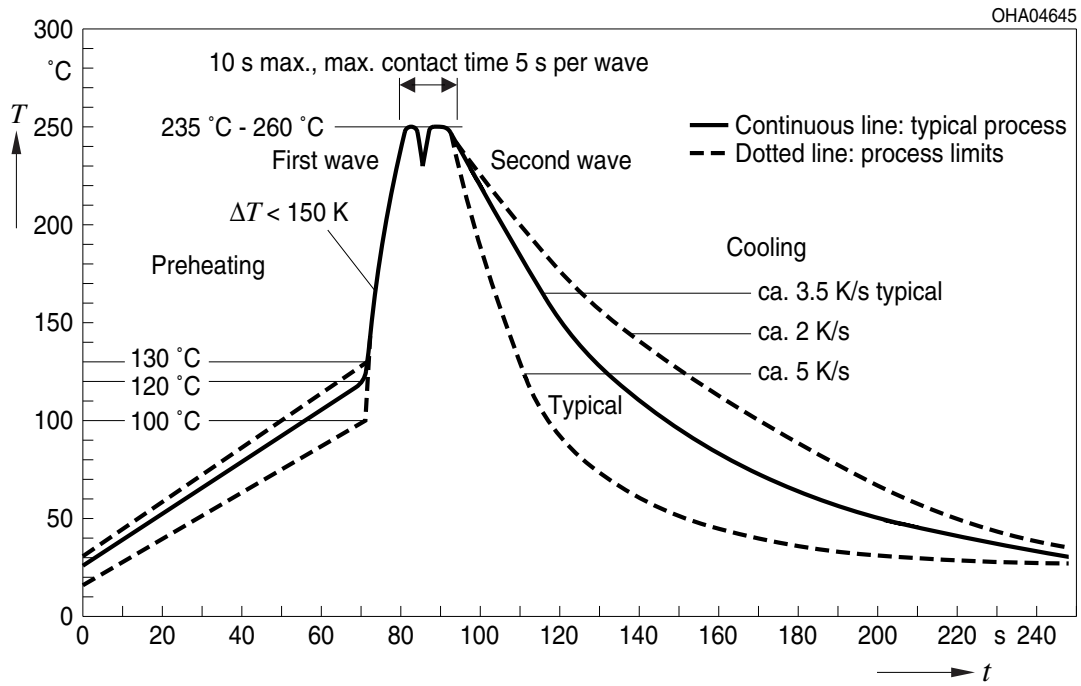

Notes

The evaluation of eye safety occurs according to the standard IEC 62471:2006 (photo biological safety of lamps and lamp systems). Within the risk grouping system of this IEC standard, the LED specified in this data sheet falls into the class **exempt group (exposure time 10000 s)**. Under real circumstances (for exposure time, conditions of the eye pupils, observation distance), it is assumed that no endangerment to the eye exists from these devices. As a matter of principle, however, it should be mentioned that intense light sources have a high secondary exposure potential due to their blinding effect. When looking at bright light sources (e.g. headlights), temporary reduction in visual acuity and afterimages can occur, leading to irritation, annoyance, visual impairment, and even accidents, depending on the situation.

Packing information is available on the internet (online product catalog).

For further application related informations please visit www.osram-os.com/appnotes

Disclaimer

Disclaimer

Language english will prevail in case of any discrepancies or deviations between the two language wordings.

Attention please!

The information describes the type of component and shall not be considered as assured characteristics. Terms of delivery and rights to change design reserved. Due to technical requirements components may contain dangerous substances.

For information on the types in question please contact our Sales Organization.

If printed or downloaded, please find the latest version in the OSRAM OS Webside.

Packing

Please use the recycling operators known to you. We can also help you – get in touch with your nearest sales office.

By agreement we will take packing material back, if it is sorted. You must bear the costs of transport. For packing material that is returned to us unsorted or which we are not obliged to accept, we shall have to invoice you for any costs incurred.

Product safety devices/applications or medical devices/applications

OSRAM OS components are not developed, constructed or tested for the application as safety relevant component or for the application in medical devices.

In case Buyer – or Customer supplied by Buyer– considers using OSRAM OS components in product safety devices/applications or medical devices/applications, Buyer and/or Customer has to inform the local sales partner of OSRAM OS immediately and OSRAM OS and Buyer and /or Customer will analyze and coordinate the customer-specific request between OSRAM OS and Buyer and/or Customer.

Glossary

- 1) **IPCEmin:** I_{PCEmin} is the min. photocurrent of the specified group.
- 2) **Typical Values:** Due to the special conditions of the manufacturing processes of LED, the typical data or calculated correlations of technical parameters can only reflect statistical figures. These do not necessarily correspond to the actual parameters of each single product, which could differ from the typical data and calculated correlations or the typical characteristic line. If requested, e.g. because of technical improvements, these typ. data will be changed without any further notice.
- 3) **Testing temperature:** $T_A = 25^\circ\text{C}$
- 4) **Tolerance of Measure:** Unless otherwise noted in drawing, tolerances are specified with ± 0.1 and dimensions are specified in mm.

Published by OSRAM Opto Semiconductors GmbH EU RoHS and China RoHS compliant product
Leibnizstraße 4, D-93055 Regensburg
www.osram-os.com © All Rights Reserved.



此产品符合欧盟 RoHS 指令的要求；
按照中国的相关法规和标准，不含有毒有害物质或元素。

单击下面可查看定价，库存，交付和生命周期等信息

[>>OSRAM\(欧司朗光电半导体\)](#)