

# SFH 4547

## Radial T1 3/4

High Power Infrared Emitter (940 nm)



### Applications

- Electronic Equipment
- Industrial Automation (Machine Controls, Light Barriers, Vision Controls)
- Safety and Security, CCTV
- Smoke/Dust/Particle Sensing

### Features:

- Package: black epoxy
- ESD: 2 kV acc. to ANSI/ESDA/JEDEC JS-001 (HBM, Class 2)
- High Power Infrared LED
- Short switching times
- UL version available (ordering code & test conditions on request)

### Ordering Information

Type	Radiant intensity <sup>1)2)</sup> $I_e$ $I_F = 100 \text{ mA}; t_p = 20 \text{ ms}$	Radiant intensity <sup>1)</sup> typ. $I_e$ $I_F = 100 \text{ mA}; t_p = 20 \text{ ms}$	Ordering Code
SFH 4547	28 ... 112 mW/sr	50 mW/sr	Q65111A1141

## Maximum Ratings

$T_A = 25\text{ °C}$

Parameter	Symbol		Values
Operating temperature	$T_{op}$	min. max.	-40 °C 100 °C
Storage temperature	$T_{stg}$	min. max.	-40 °C 100 °C
Forward current	$I_F$	max.	100 mA
Forward current pulsed $t_p \leq 400\ \mu\text{s}$ ; $D \leq 0.005$	$I_{F\ pulse}$	max.	1 A
Reverse voltage <sup>3)</sup>	$V_R$	max.	5 V
Power consumption	$P_{tot}$	max.	180 mW
ESD withstand voltage acc. to ANSI/ESDA/JEDEC JS-001 (HBM, Class 2)	$V_{ESD}$	max.	2 kV

## Characteristics

$I_F = 100 \text{ mA}$ ;  $t_p = 20 \text{ ms}$ ;  $T_A = 25 \text{ °C}$

Parameter	Symbol		Values
Peak wavelength	$\lambda_{\text{peak}}$	typ.	950 nm
Centroid wavelength	$\lambda_{\text{centroid}}$	typ.	940 nm
Spectral bandwidth at 50% $I_{\text{rel,max}}$ (FWHM)	$\Delta\lambda$	typ.	42 nm
Half angle	$\varphi$	typ.	30 °
Dimensions of active chip area	L x W	typ.	0.3 x 0.3 mm x mm
Rise time (10% / 90%) $I_F = 100 \text{ mA}$ ; $R_L = 50 \text{ }\Omega$	$t_r$	typ.	12 ns
Fall time (10% / 90%) $I_F = 100 \text{ mA}$ ; $R_L = 50 \text{ }\Omega$	$t_f$	typ.	12 ns
Forward voltage <sup>4)</sup>	$V_F$	typ. max.	1.5 V 1.7 V
Forward voltage <sup>4)</sup> $I_F = 1 \text{ A}$ ; $t_p = 100 \text{ }\mu\text{s}$	$V_F$	typ. max.	2.3 V 2.9 V
Reverse current <sup>3)</sup> $V_R = 5 \text{ V}$	$I_R$	typ. max.	0.01 $\mu\text{A}$ 10 $\mu\text{A}$
Radiant intensity <sup>1)</sup> $I_F = 1 \text{ A}$ ; $t_p = 25 \text{ }\mu\text{s}$	$I_e$	typ.	375 mW/sr
Total radiant flux <sup>5)</sup>	$\Phi_e$	typ.	55 mW
Temperature coefficient of voltage	$TC_V$	typ.	-1.3 mV / K
Temperature coefficient of brightness	$TC_I$	typ.	-0.5 % / K
Temperature coefficient of wavelength	$TC_\lambda$	typ.	0.3 nm / K
Thermal resistance junction ambient real <sup>6)</sup>	$R_{\text{thJA}}$	max.	450 K / W

### Brightness Groups

$T_A = 25\text{ °C}$

Group	Radiant intensity <sup>1)2)</sup> $I_F = 100\text{ mA}; t_p = 20\text{ ms}$ min. $I_e$	Radiant intensity <sup>1)2)</sup> $I_F = 100\text{ mA}; t_p = 20\text{ ms}$ max. $I_e$
	T	28 mW/sr
U	45 mW/sr	71 mW/sr
V	71 mW/sr	112 mW/sr

Only one group in one packing unit (variation lower 2:1).

### Relative Spectral Emission <sup>7), 8)</sup>

$I_{e,rel} = f(\lambda); I_F = 100\text{ mA}; t_p = 20\text{ ms}$

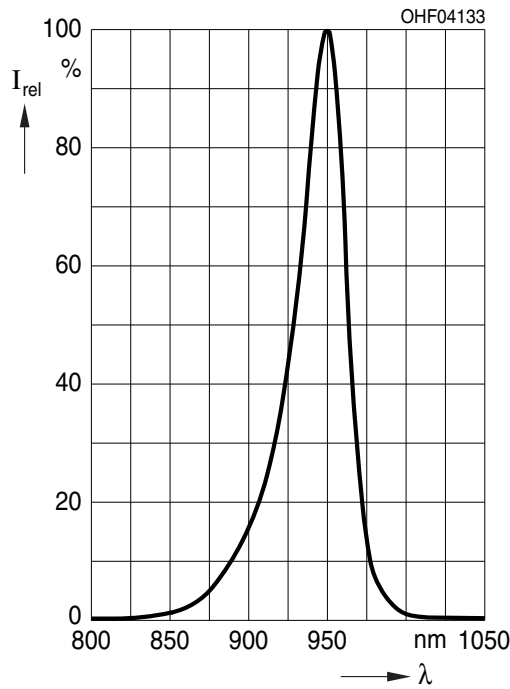

**Radiation Characteristics** (7), 8)

$I_{e,rel} = f(\varphi)$

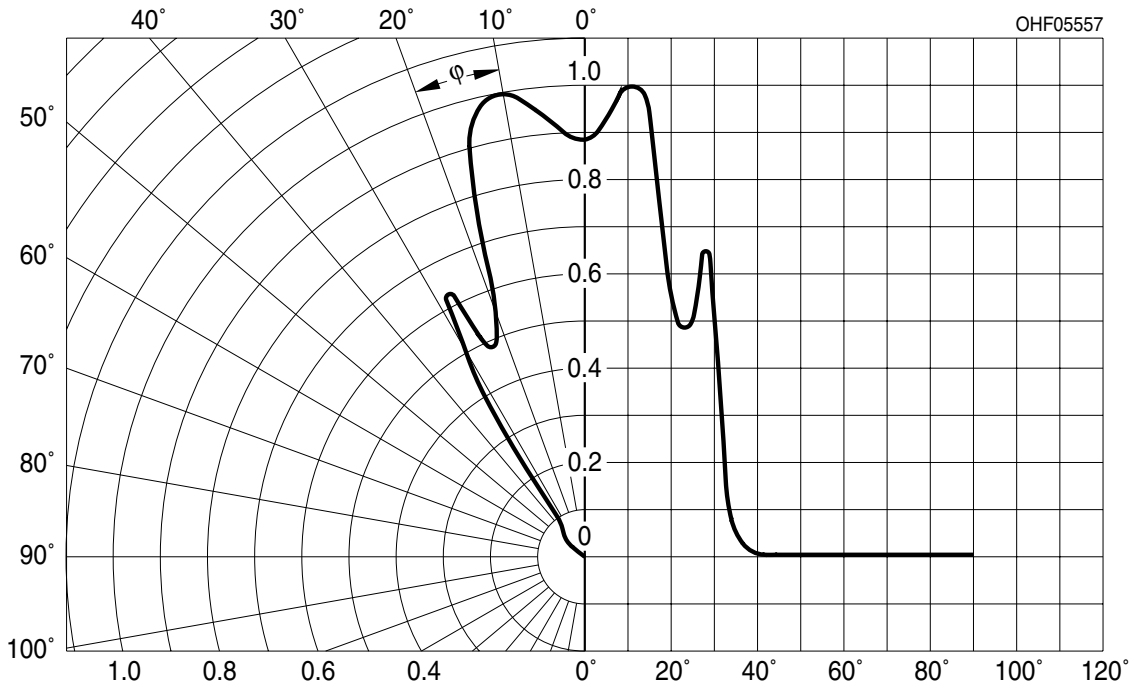

**Forward current** (7), 8)

$I_F = f(V_F)$ ; single pulse;  $t_p = 100 \mu s$

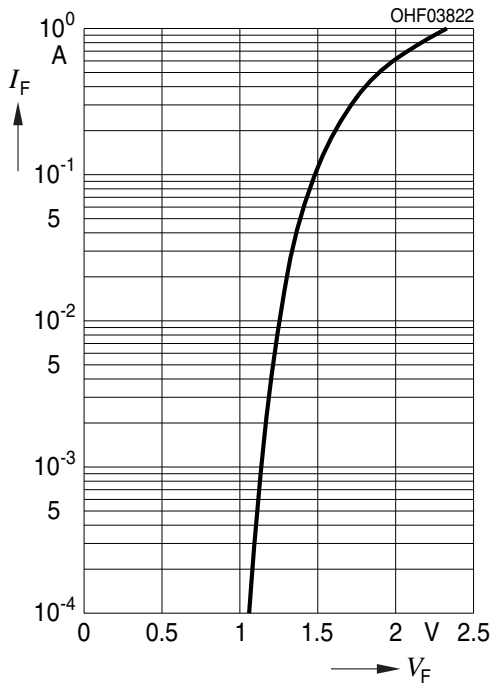

**Radiant Intensity** (7), 8)

$I_e/I_e(100mA) = f(I_F)$ ; single pulse;  $t_p = 25 \mu s$

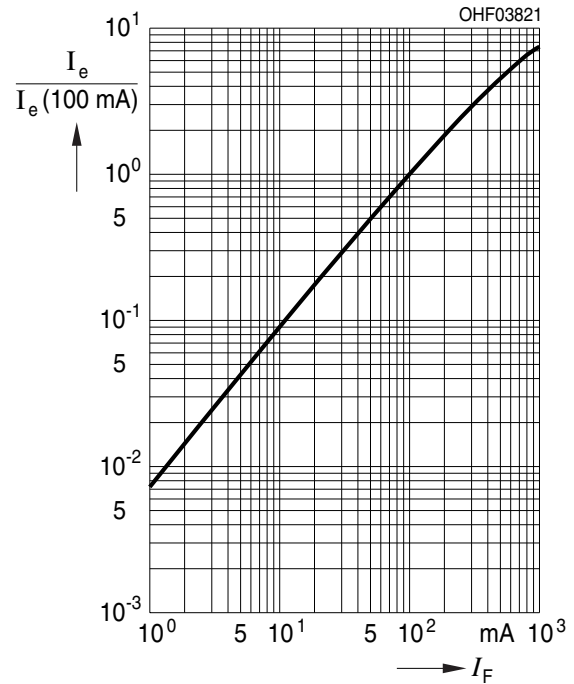

### Max. Permissible Forward Current

$I_{F,max} = f(T_A)$ ;  $R_{th,ja} = 450K / W$

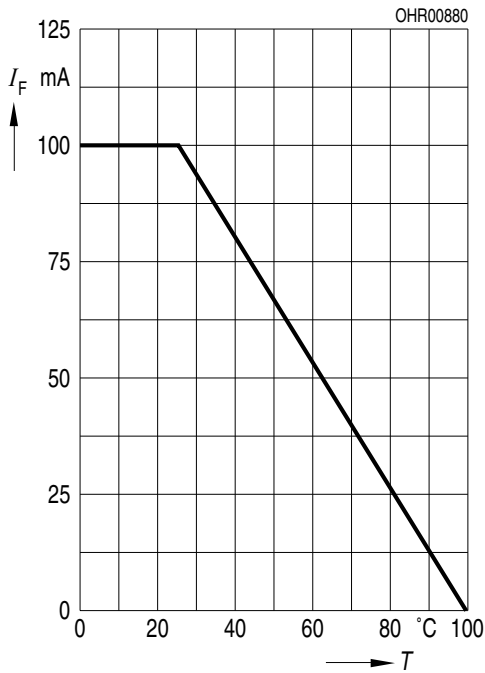

### Permissible Pulse Handling Capability

$I_F = f(t_p)$ ; duty cycle D = parameter;  $T_A = 25^\circ C$

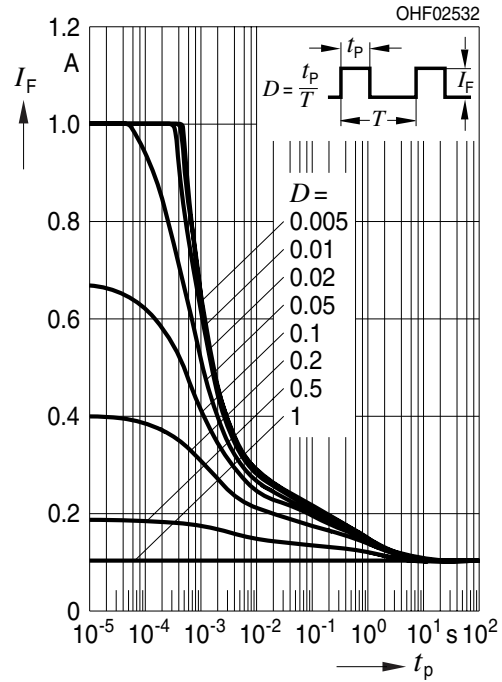

### Permissible Pulse Handling Capability

$I_F = f(t_p)$ ; duty cycle D = parameter;  $T_A = 85^\circ C$

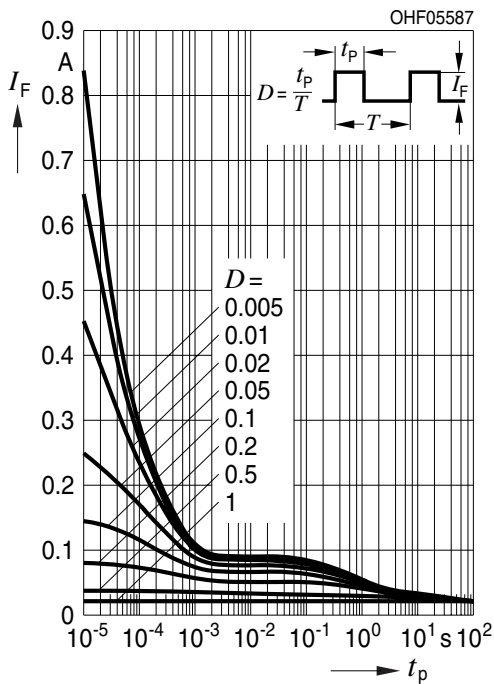



**Recommended Solder Pad** <sup>9)</sup>

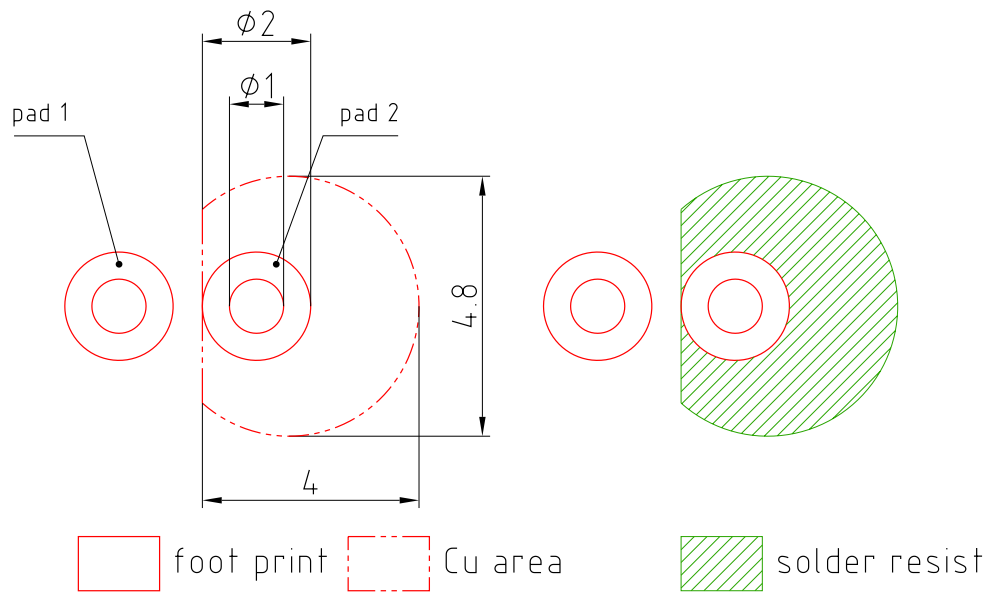

E062.3010.188-01

Pad 1: cathode



# TTW Soldering

IEC-61760-1 TTW

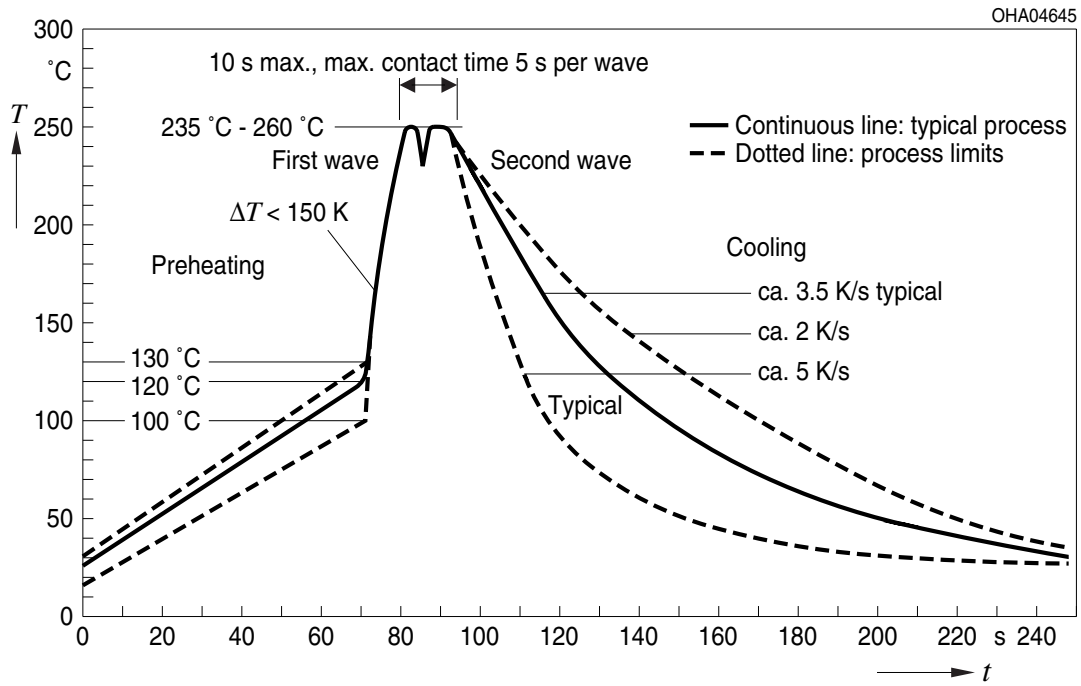

OHA04645

## Notes

The evaluation of eye safety occurs according to the standard IEC 62471:2006 (photo biological safety of lamps and lamp systems). Within the risk grouping system of this IEC standard, the device specified in this data sheet fall into the class **exempt group (exposure time 10000 s)**. Under real circumstances (for exposure time, conditions of the eye pupils, observation distance), it is assumed that no endangerment to the eye exists from these devices. As a matter of principle, however, it should be mentioned that intense light sources have a high secondary exposure potential due to their blinding effect. When looking at bright light sources (e.g. headlights), temporary reduction in visual acuity and afterimages can occur, leading to irritation, annoyance, visual impairment, and even accidents, depending on the situation.

Subcomponents of this device contain, in addition to other substances, metal filled materials including silver. Metal filled materials can be affected by environments that contain traces of aggressive substances. Therefore, we recommend that customers minimize device exposure to aggressive substances during storage, production, and use. Devices that showed visible discoloration when tested using the described tests above did show no performance deviations within failure limits during the stated test duration. Respective failure limits are described in the IEC60810.

Packing information is available on the internet (online product catalog).

For further application related information please visit [www.osram-os.com/appnotes](http://www.osram-os.com/appnotes)

## Disclaimer

### Attention please!

The information describes the type of component and shall not be considered as assured characteristics. Terms of delivery and rights to change design reserved. Due to technical requirements components may contain dangerous substances.

For information on the types in question please contact our Sales Organization.

If printed or downloaded, please find the latest version on the OSRAM OS website.

### Packing

Please use the recycling operators known to you. We can also help you – get in touch with your nearest sales office. By agreement we will take packing material back, if it is sorted. You must bear the costs of transport. For packing material that is returned to us unsorted or which we are not obliged to accept, we shall have to invoice you for any costs incurred.

### Product and functional safety devices/applications or medical devices/applications

OSRAM OS components are not developed, constructed or tested for the application as safety relevant component or for the application in medical devices.

OSRAM OS products are not qualified at module and system level for such application.

In case buyer – or customer supplied by buyer – considers using OSRAM OS components in product safety devices/applications or medical devices/applications, buyer and/or customer has to inform the local sales partner of OSRAM OS immediately and OSRAM OS and buyer and /or customer will analyze and coordinate the customer-specific request between OSRAM OS and buyer and/or customer.

---

## Glossary

- 1) **Radiant intensity:** Measured at a solid angle of  $\Omega = 0.01$  sr
- 2) **Brightness:** The brightness values are measured with a tolerance of  $\pm 11\%$ .
- 3) **Reverse Operation:** This product is intended to be operated applying a forward current within the specified range. Applying any continuous reverse bias or forward bias below the voltage range of light emission shall be avoided because it may cause migration which can change the electro-optical characteristics or damage the LED.
- 4) **Forward Voltage:** The forward voltages are measured with a tolerance of  $\pm 0.1$  V.
- 5) **Total radiant flux:** Measured with integrating sphere.
- 6) **Thermal resistance:** junction - ambient, mounted on PC-board (FR4), padsize 16 mm<sup>2</sup> each
- 7) **Typical Values:** Due to the special conditions of the manufacturing processes of semiconductor devices, the typical data or calculated correlations of technical parameters can only reflect statistical figures. These do not necessarily correspond to the actual parameters of each single product, which could differ from the typical data and calculated correlations or the typical characteristic line. If requested, e.g. because of technical improvements, these typ. data will be changed without any further notice.
- 8) **Testing temperature:** TA = 25°C (unless otherwise specified)
- 9) **Tolerance of Measure:** Unless otherwise noted in drawing, tolerances are specified with  $\pm 0.1$  and dimensions are specified in mm.

---

## Revision History

Version	Date	Change
1.5	2021-10-13	Maximum Ratings Characteristics
1.6	2021-11-18	Features

Published by OSRAM Opto Semiconductors GmbH EU RoHS and China RoHS compliant product  
Leibnizstraße 4, D-93055 Regensburg  
www.osram-os.com © All Rights Reserved.



此产品符合欧盟 RoHS 指令的要求；  
按照中国的相关法规和标准，不含有毒有害物质或元素。

单击下面可查看定价，库存，交付和生命周期等信息

[>>OSRAM\(欧司朗光电半导体\)](#)