

# KO DELPS1.22

## TOPLED® E1608

The TOPLED E1608 expands OSRAM Opto Semiconductors' low power portfolio by offering one of the smallest LED Industry standard footprints in a highly reliable and well proved package concept.

Its outstanding performance is suitable for a huge variety of applications especially automotive interior where a small package design with excellent reliability is needed. The TOPLED E1608 is available in different colors and brightness levels.



## Applications

- Cluster, Button Backlighting
- Electronic Equipment
- Interior Illumination (e.g. Ambient Map)

## Features:

- Package: white SMT package, colorless clear resin
- Chip technology: Thinfilm
- Typ. Radiation: 120° (Lambertian emitter)
- Color:  $\lambda_{\text{dom}} = 606 \text{ nm}$  (● orange)
- Corrosion Robustness Class: 2B
- Qualifications: AEC-Q102 Qualified
- ESD: 2 kV acc. to ANSI/ESDA/JEDEC JS-001 (HBM, Class 2)

---

## Ordering Information

| Type                      | Luminous Intensity <sup>1)</sup><br>$I_F = 20 \text{ mA}$<br>$I_v$ | Ordering Code |
|---------------------------|--|---------------|
| KO DELPS1.22-UGVI-24-H3Q4 | 450 ... 1120 mcd   | Q65112A3997   |

---

## Maximum Ratings

| Parameter  | Symbol    |      | Values |
|--|-----------|------|--------|
| Operating Temperature  | $T_{op}$  | min. | -40 °C |
|  |           | max. | 110 °C |
| Storage Temperature  | $T_{stg}$ | min. | -40 °C |
|  |           | max. | 110 °C |
| Junction Temperature   | $T_j$     | max. | 125 °C |
| Forward current<br>$T_s = 25\text{ °C}$  | $I_F$     | max. | 30 mA  |
| Surge Current<br>$t \leq 10\text{ }\mu\text{s}$ ; $D = 0.005$ ; $T_s = 25\text{ °C}$ | $I_{FS}$  | max. | 70 mA  |
| Reverse voltage <sup>2)</sup><br>$T_s = 25\text{ °C}$                                | $V_R$     | max. | 12 V   |
| ESD withstand voltage<br>acc. to ANSI/ESDA/JEDEC JS-001 (HBM, Class 2)               | $V_{ESD}$ |      | 2 kV   |

## Characteristics

$I_F = 20 \text{ mA}$ ;  $T_S = 25 \text{ }^\circ\text{C}$

| Parameter   | Symbol                              |                      | Values                                 |
|---|-------------------------------------|----------------------|--|
| Peak Wavelength   | $\lambda_{\text{peak}}$             | typ.                 | 610 nm                                 |
| Dominant Wavelength <sup>3)</sup><br>$I_F = 20 \text{ mA}$                                      | $\lambda_{\text{dom}}$              | min.<br>typ.<br>max. | 600 nm<br>606 nm<br>609 nm             |
| Spectral Bandwidth at 50% $I_{\text{rel,max}}$  | $\Delta\lambda$                     | typ.                 | 17 nm                                  |
| Viewing angle at 50% $I_V$  | $2\varphi$                          | typ.                 | 120 °                                  |
| Forward Voltage <sup>4)</sup><br>$I_F = 20 \text{ mA}$  | $V_F$                               | min.<br>typ.<br>max. | 1.95 V<br>2.30 V<br>2.50 V             |
| Reverse current <sup>2)</sup><br>$V_R = 12 \text{ V}$   | $I_R$                               | typ.<br>max.         | 0.01 $\mu\text{A}$<br>10 $\mu\text{A}$ |
| Temperature Coefficient of Peak Wavelength<br>$-10^\circ\text{C} \leq T \leq 100^\circ\text{C}$ | $\text{TC}_{\lambda_{\text{peak}}}$ | typ.                 | 0.14 nm / K                            |
| Real thermal resistance junction/ambient <sup>5)6)</sup>  | $R_{\text{thJA real}}$              | max.                 | 510 K / W                              |
| Real thermal resistance junction/solderpoint <sup>5)</sup>                                      | $R_{\text{thJS real}}$              | typ.<br>max.         | 120 K / W<br>150 K / W                 |

## Brightness Groups

| Group | Luminous Intensity <sup>1)</sup><br>$I_F = 20 \text{ mA}$<br>min.<br>$I_v$ | Luminous Intensity. <sup>1)</sup><br>$I_F = 20 \text{ mA}$<br>max.<br>$I_v$ | Luminous Flux <sup>7)</sup><br>$I_F = 20 \text{ mA}$<br>typ.<br>$\Phi_v$ |
|-------|--|---|--|
| UG    | 450 mcd  | 520 mcd   | 1600 mlm   |
| UH    | 520 mcd  | 610 mcd   | 1900 mlm   |
| UI    | 610 mcd  | 710 mcd   | 2200 mlm   |
| VG    | 710 mcd  | 820 mcd   | 2500 mlm   |
| VH    | 820 mcd  | 970 mcd   | 3000 mlm   |
| VI    | 970 mcd  | 1120 mcd  | 3400 mlm   |

## Forward Voltage Groups

| Group | Forward Voltage <sup>4)</sup><br>$I_F = 20 \text{ mA}$<br>min.<br>$V_F$ | Forward Voltage <sup>4)</sup><br>$I_F = 20 \text{ mA}$<br>max.<br>$V_F$ |
|-------|---|---|
| H3    | 1.95 V  | 2.10 V  |
| L4    | 2.10 V  | 2.30 V  |
| Q4    | 2.30 V  | 2.50 V  |

## Wavelength Groups

| Group | Dominant Wavelength <sup>3)</sup><br>$I_F = 20 \text{ mA}$<br>min.<br>$\lambda_{\text{dom}}$ | Dominant Wavelength <sup>3)</sup><br>$I_F = 20 \text{ mA}$<br>max.<br>$\lambda_{\text{dom}}$ |
|-------|--|--|
| 2     | 600 nm   | 603 nm   |
| 3     | 603 nm   | 606 nm   |
| 4     | 606 nm   | 609 nm   |

---

## Group Name on Label

**Example: UG-2-H3**

| Brightness | Wavelength | Forward Voltage |
|------------|------------|-----------------|
| UG         | 2          | H3              |

---

### Relative Spectral Emission <sup>7)</sup>

$I_{rel} = f(\lambda); I_F = 20 \text{ mA}; T_S = 25 \text{ }^\circ\text{C}$

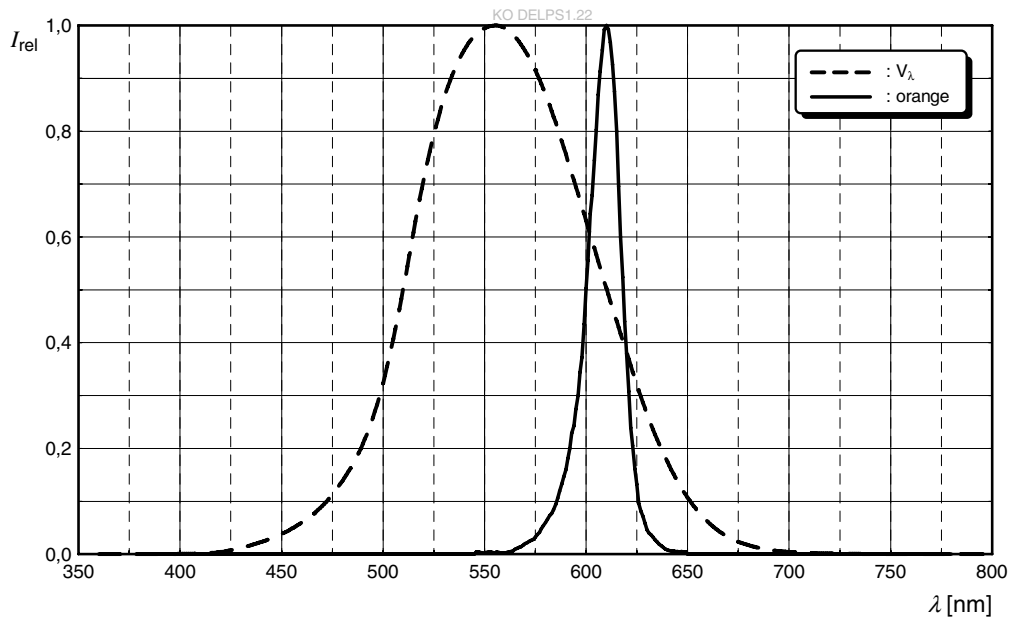

### Radiation Characteristics <sup>7)</sup>

$I_{rel} = f(\phi); T_S = 25 \text{ }^\circ\text{C}$

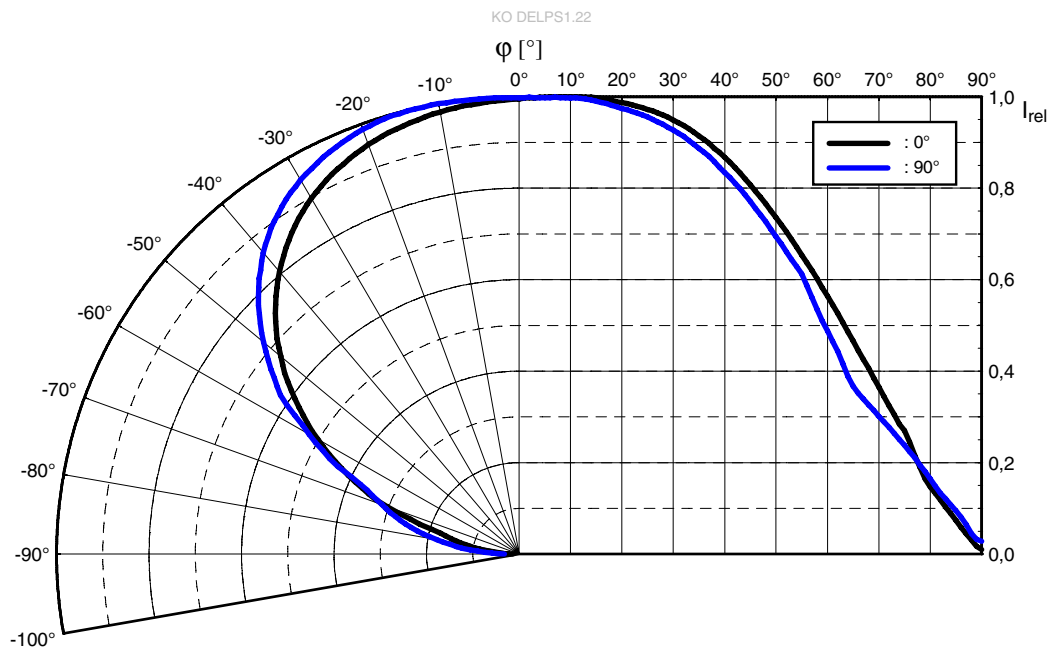

**Forward current** 7), 8)

$I_F = f(V_F); T_S = 25\text{ °C}$

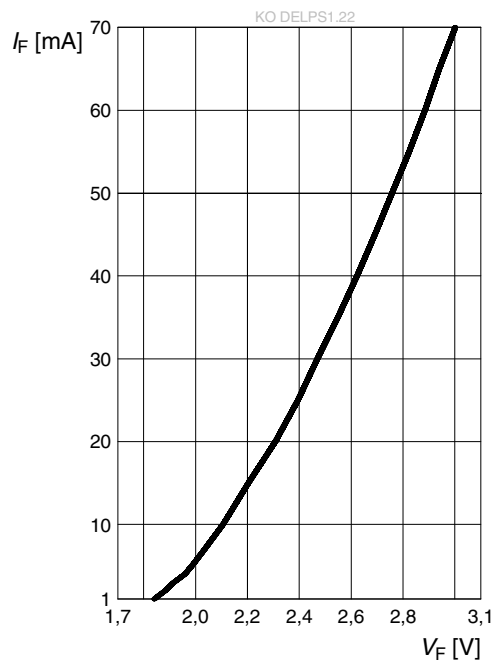

**Relative Luminous Intensity** 7), 8)

$I_V/I_V(20\text{ mA}) = f(I_F); T_S = 25\text{ °C}$

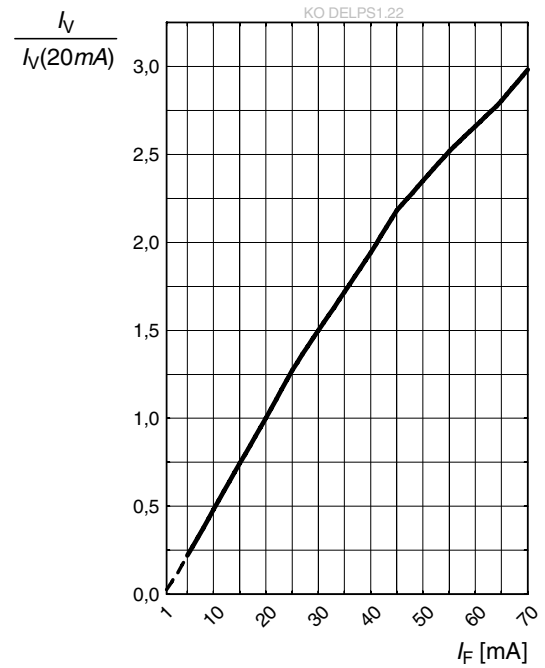



### Forward Voltage <sup>7)</sup>

$$\Delta V_F = V_F - V_F(25\text{ }^\circ\text{C}) = f(T_j); I_F = 20\text{ mA}$$

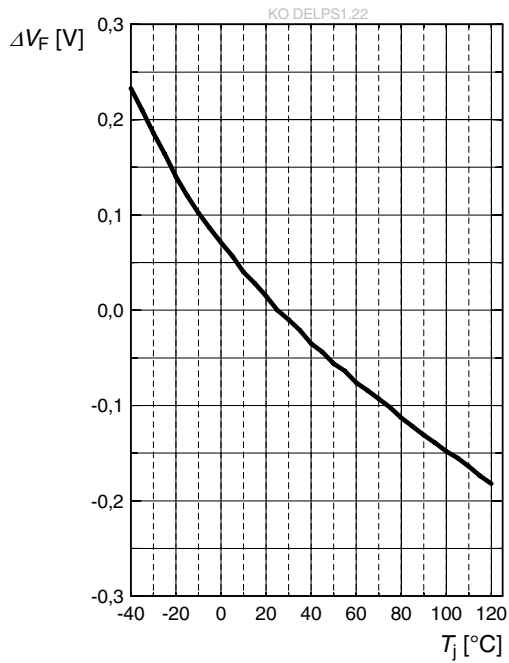

### Relative Luminous Intensity <sup>7)</sup>

$$I_V/I_V(25\text{ }^\circ\text{C}) = f(T_j); I_F = 20\text{ mA}$$

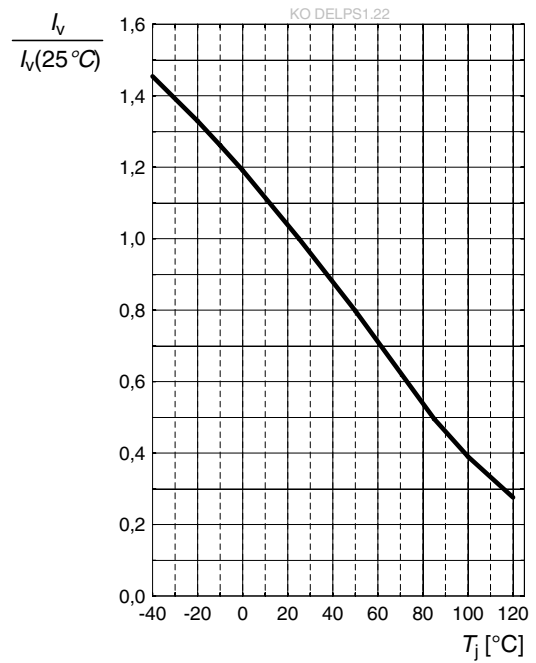

### Dominant Wavelength <sup>7)</sup>

$$\Delta \lambda_{\text{dom}} = \lambda_{\text{dom}} - \lambda_{\text{dom}}(25\text{ }^\circ\text{C}) = f(T_j); I_F = 20\text{ mA}$$

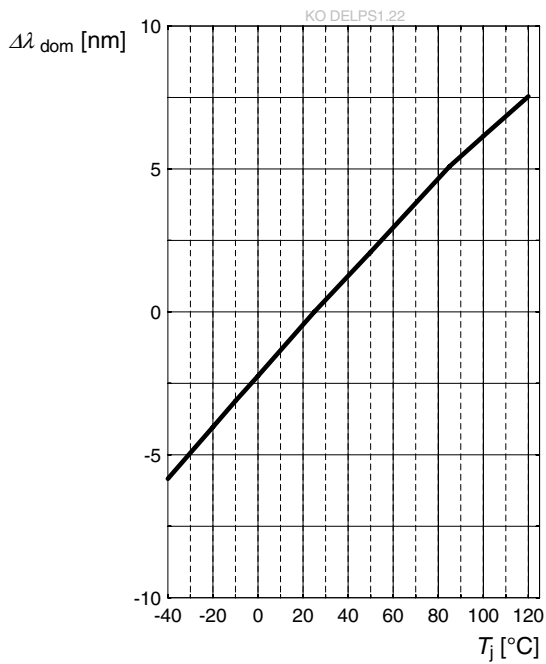

## Max. Permissible Forward Current

$$I_F = f(T)$$

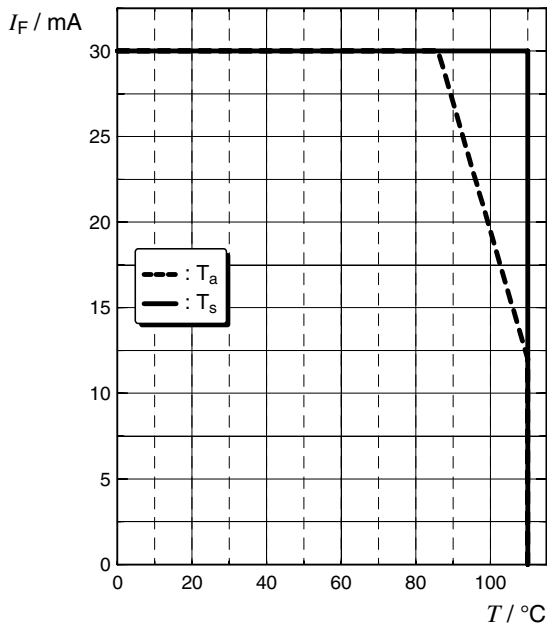

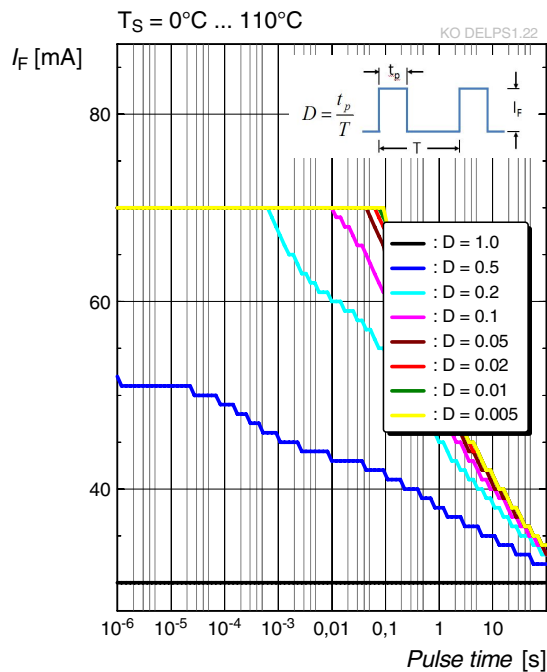

## Permissible Pulse Handling Capability

$$I_F = f(t_p); D: \text{Duty cycle}$$

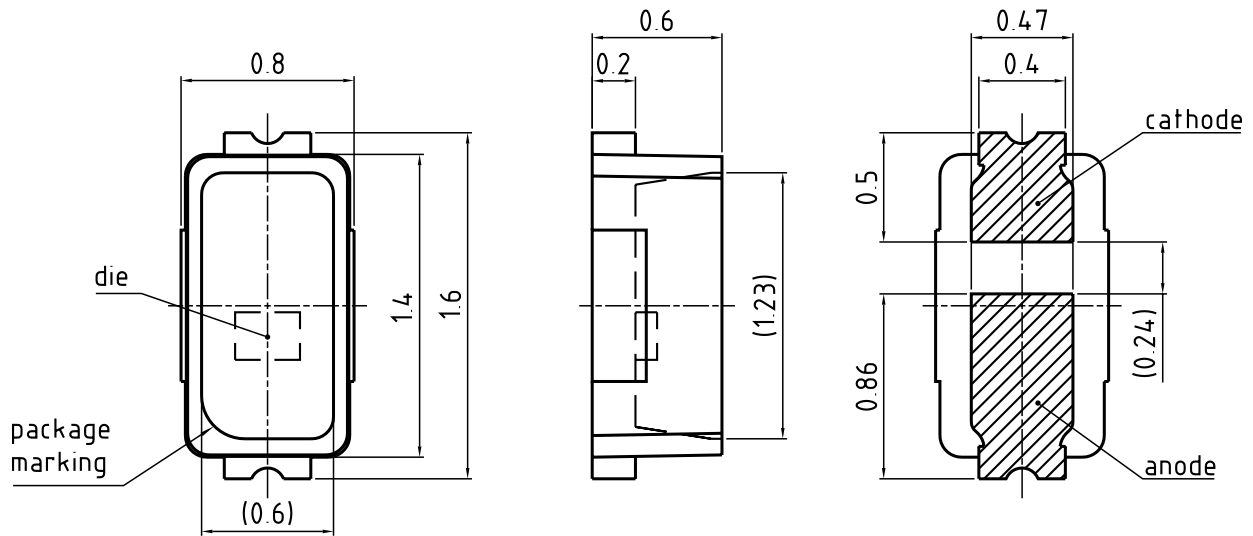

**Dimensional Drawing** <sup>9)</sup>



general tolerance  $\pm 0.1$   
 lead finish Ag 

C63062-A4275-A1.-02

**Further Information:**

**Approximate Weight:** 2.0 mg

**Package marking:** Anode

**Corrosion test:** Class: 2B

Test condition: 25°C / 75 % RH / 10 ppm H<sub>2</sub>S / 21 days (IEC 60068-2-43)

---

## Electrical Internal Circuit

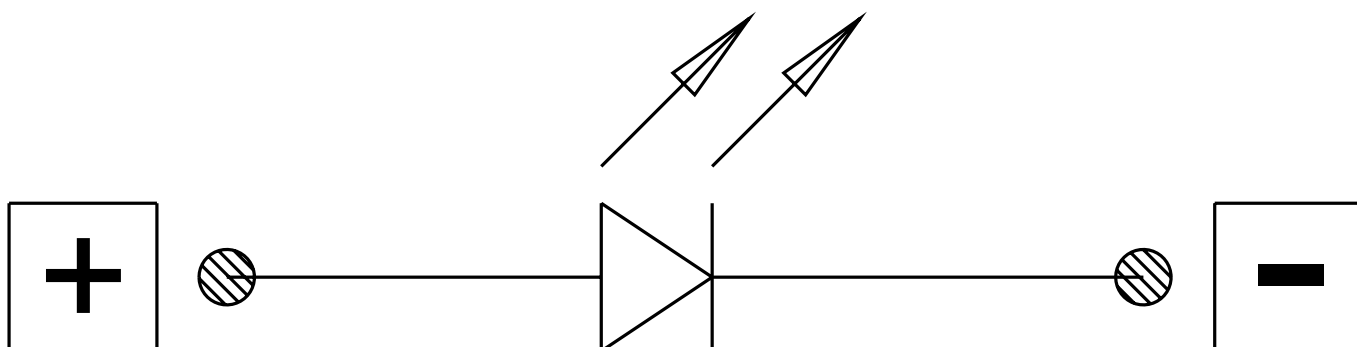

## Recommended Solder Pad <sup>9)</sup>

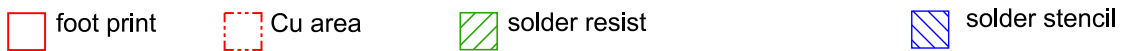
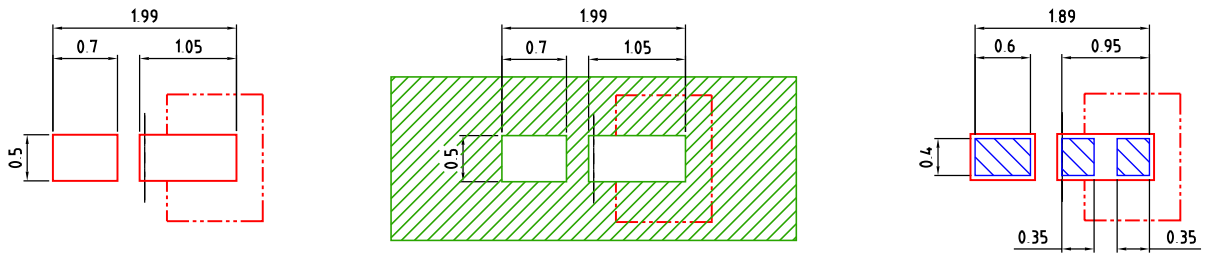

The usage of solder resist between anode and cathode pads is mandatory for applications where water may condense

### Component Location on Pad

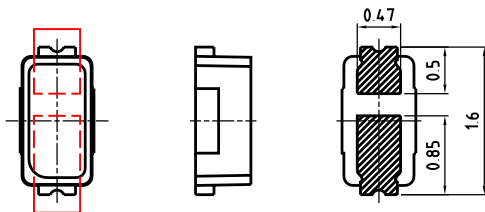

E062.3010.187 -02

All products are packed in a dry pack bag (Moisture Barrier Bag, MBB) according MIL-PRF-81705, after opening the MBB the products should go to reflow soldering process. Unused remaining LEDs should be protected from environment due to silver plated soldering terminal. In order to maintain solderability it is recommended to protect the silver plated solder terminals from corrosive environment before soldering. For superior solder joint connectivity results we recommend soldering under standard nitrogen atmosphere.

## Reflow Soldering Profile

Product complies to MSL Level 2 acc. to JEDEC J-STD-020E

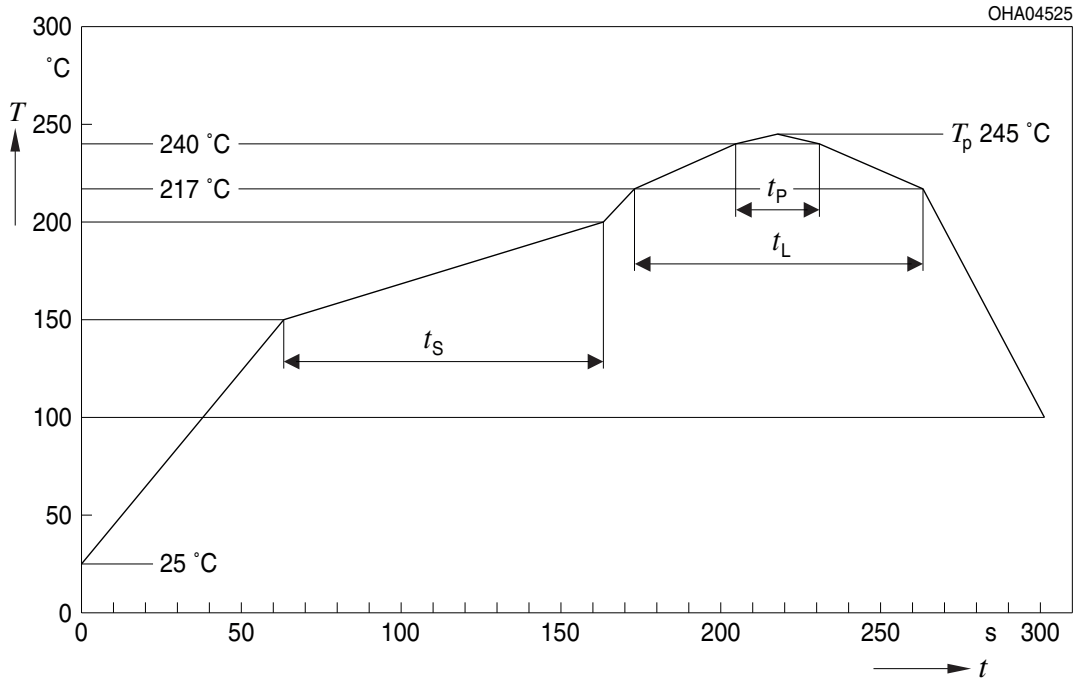

| Profile Feature  | Symbol | Pb-Free (SnAgCu) Assembly |                |         | Unit |
|--|--------|---------------------------|----------------|---------|------|
|  |        | Minimum                   | Recommendation | Maximum |      |
| Ramp-up rate to preheat <sup>*)</sup><br>25 °C to 150 °C       |        |                           | 2              | 3       | K/s  |
| Time $t_s$<br>$T_{Smin}$ to $T_{Smax}$                         | $t_s$  | 60                        | 100            | 120     | s    |
| Ramp-up rate to peak <sup>*)</sup><br>$T_{Smax}$ to $T_p$      |        |                           | 2              | 3       | K/s  |
| Liquidus temperature   | $T_L$  |                           | 217            |         | °C   |
| Time above liquidus temperature                                | $t_L$  |                           | 80             | 100     | s    |
| Peak temperature   | $T_p$  |                           | 245            | 260     | °C   |
| Time within 5 °C of the specified peak temperature $T_p - 5$ K | $t_p$  | 10                        | 20             | 30      | s    |
| Ramp-down rate*<br>$T_p$ to 100 °C                             |        |                           | 3              | 6       | K/s  |
| Time<br>25 °C to $T_p$   |        |                           |                | 480     | s    |

All temperatures refer to the center of the package, measured on the top of the component

\* slope calculation  $DT/Dt$ :  $Dt$  max. 5 s; fulfillment for the whole T-range

**Taping** <sup>9)</sup>

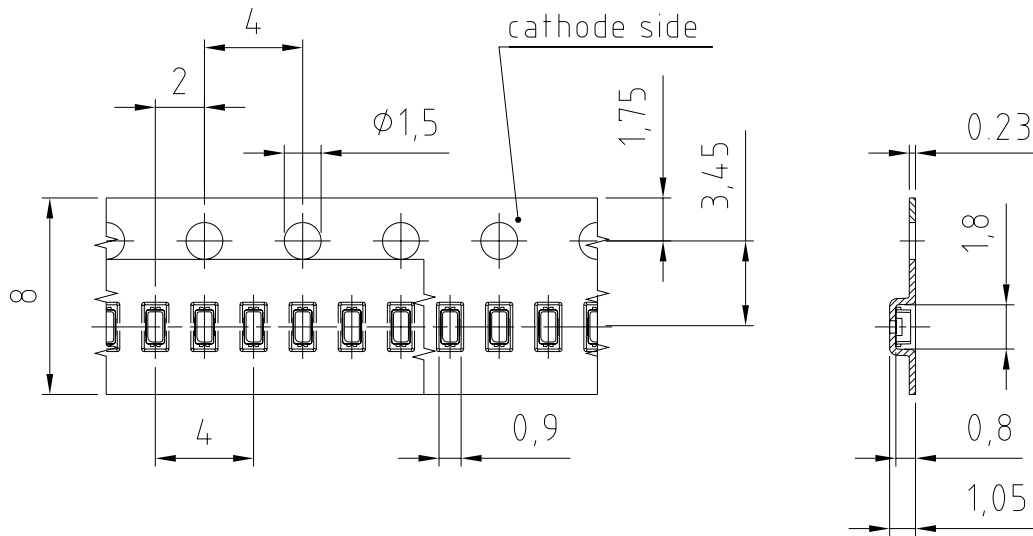

C63062-A4275-B5 -02

**Tape and Reel** <sup>10)</sup>



**Reel Dimensions**

| A      | W                    | $N_{\min}$ | $W_1$        | $W_{2\max}$ | Pieces per PU |
|--------|----------------------|------------|--------------|-------------|---------------|
| 180 mm | $8 + 0.3 / - 0.1$ mm | 60 mm      | $8.4 + 2$ mm | 14.4 mm     | 5000          |



## Barcode-Product-Label (BPL)

**OSRAM Opto Semiconductors** LX XXXX    BIN1: XX-XX-X-XXX-X

RoHS Compliant

(6P) BATCH NO: 1234567890 ML Temp    ST  
X    XXX °C X

(1T) LOT NO: 1234567890 (9D) D/C: 1234

(X) PROD NO: 123456789(Q)QTY: 9999 (G) GROUP: XX-XX-X-X

Pack: RXX  
DEMY    XXX  
X\_X123\_1234.1234 X



OHA04563

## Dry Packing Process and Materials <sup>9)</sup>



OHA00539

Moisture-sensitive product is packed in a dry bag containing desiccant and a humidity card according JEDEC-STD-033.

## Type Designation System

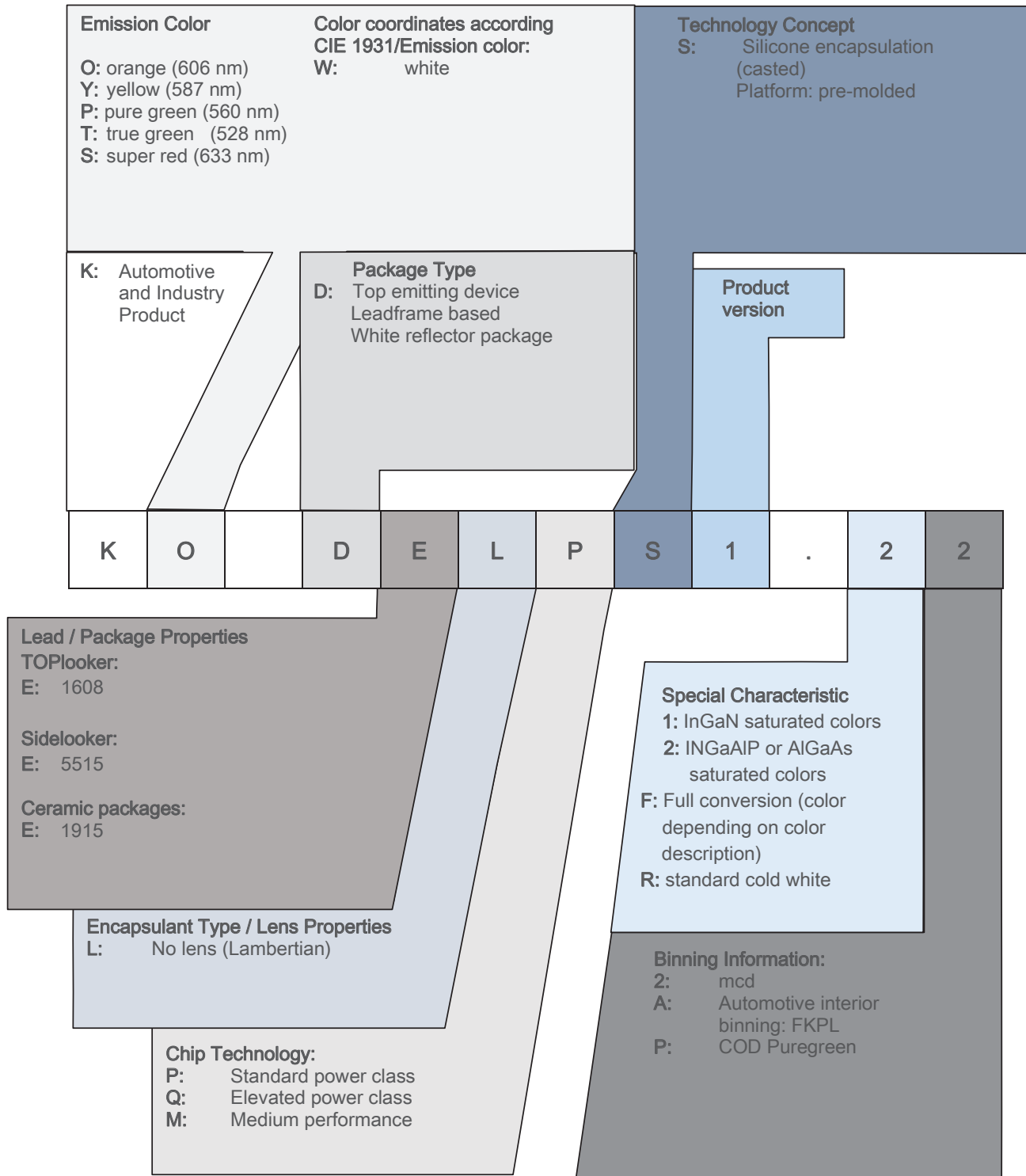

## Notes

The evaluation of eye safety occurs according to the standard IEC 62471:2006 (photo biological safety of lamps and lamp systems). Within the risk grouping system of this IEC standard, the device specified in this data sheet falls into the class **exempt group (exposure time 10000 s)**. Under real circumstances (for exposure time, conditions of the eye pupils, observation distance), it is assumed that no endangerment to the eye exists from these devices. As a matter of principle, however, it should be mentioned that intense light sources have a high secondary exposure potential due to their blinding effect. When looking at bright light sources (e.g. headlights), temporary reduction in visual acuity and afterimages can occur, leading to irritation, annoyance, visual impairment, and even accidents, depending on the situation.

Subcomponents of this device contain, in addition to other substances, metal filled materials including silver. Metal filled materials can be affected by environments that contain traces of aggressive substances. Therefore, we recommend that customers minimize device exposure to aggressive substances during storage, production, and use. Devices that showed visible discoloration when tested using the described tests above did show no performance deviations within failure limits during the stated test duration. Respective failure limits are described in the IEC60810.

For further application related information please visit [www.osram-os.com/appnotes](http://www.osram-os.com/appnotes)

## Disclaimer

### Attention please!

The information describes the type of component and shall not be considered as assured characteristics. Terms of delivery and rights to change design reserved. Due to technical requirements components may contain dangerous substances.

For information on the types in question please contact our Sales Organization.

If printed or downloaded, please find the latest version on the OSRAM OS website.

### Packing

Please use the recycling operators known to you. We can also help you – get in touch with your nearest sales office. By agreement we will take packing material back, if it is sorted. You must bear the costs of transport. For packing material that is returned to us unsorted or which we are not obliged to accept, we shall have to invoice you for any costs incurred.

### Product and functional safety devices/applications or medical devices/applications

OSRAM OS components are not developed, constructed or tested for the application as safety relevant component or for the application in medical devices.

OSRAM OS products are not qualified at module and system level for such application.

In case buyer – or customer supplied by buyer – considers using OSRAM OS components in product safety devices/applications or medical devices/applications, buyer and/or customer has to inform the local sales partner of OSRAM OS immediately and OSRAM OS and buyer and /or customer will analyze and coordinate the customer-specific request between OSRAM OS and buyer and/or customer.

---

## Glossary

- 1) **Brightness:** Brightness values are measured during a current pulse of typically 25 ms, with an internal reproducibility of  $\pm 8\%$  and an expanded uncertainty of  $\pm 11\%$  (acc. to GUM with a coverage factor of  $k = 3$ ).
- 2) **Reverse Operation:** This product is intended to be operated applying a forward current within the specified range. Applying any continuous reverse bias or forward bias below the voltage range of light emission shall be avoided because it may cause migration which can change the electro-optical characteristics or damage the LED.
- 3) **Wavelength:** The wavelength is measured at a current pulse of typically 25 ms, with an internal reproducibility of  $\pm 0.5$  nm and an expanded uncertainty of  $\pm 1$  nm (acc. to GUM with a coverage factor of  $k = 3$ ).
- 4) **Forward Voltage:** The forward voltage is measured during a current pulse of typically 8 ms, with an internal reproducibility of  $\pm 0.05$  V and an expanded uncertainty of  $\pm 0.1$  V (acc. to GUM with a coverage factor of  $k = 3$ ).
- 5) **Thermal Resistance:**  $R_{th\ max}$  is based on statistic values ( $6\sigma$ ).
- 6) **Thermal Resistance:**  $R_{thJA}$  results from mounting on PC board FR 4 (pad size 16 mm<sup>2</sup> per pad)
- 7) **Typical Values:** Due to the special conditions of the manufacturing processes of semiconductor devices, the typical data or calculated correlations of technical parameters can only reflect statistical figures. These do not necessarily correspond to the actual parameters of each single product, which could differ from the typical data and calculated correlations or the typical characteristic line. If requested, e.g. because of technical improvements, these typ. data will be changed without any further notice.
- 8) **Characteristic curve:** In the range where the line of the graph is broken, you must expect higher differences between single devices within one packing unit.
- 9) **Tolerance of Measure:** Unless otherwise noted in drawing, tolerances are specified with  $\pm 0.1$  and dimensions are specified in mm.
- 10) **Tape and Reel:** All dimensions and tolerances are specified acc. IEC 60286-3 and specified in mm.

---

## Revision History

| Version | Date       | Change   |
|---------|------------|--|
| 1.7     | 2019-03-18 | Maximum Ratings  |
| 1.8     | 2020-03-05 | Derating (Diagrams)  |
| 1.9     | 2020-03-09 | Schematic Transportation Box<br>Dimensions of Transportation Box |
| 1.10    | 2020-06-04 | Further Information  |

Published by OSRAM Opto Semiconductors GmbH EU RoHS and China RoHS compliant product  
Leibnizstraße 4, D-93055 Regensburg  
www.osram-os.com © All Rights Reserved.



此产品符合欧盟 RoHS 指令的要求；  
按照中国的相关法规和标准，不含有毒有害物质或元素。

单击下面可查看定价，库存，交付和生命周期等信息

[>>OSRAM\(欧司朗光电半导体\)](#)