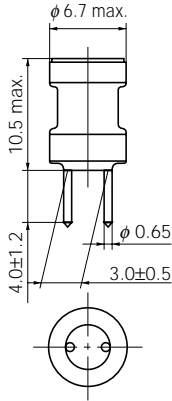
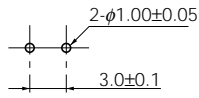
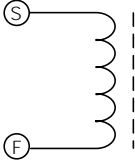
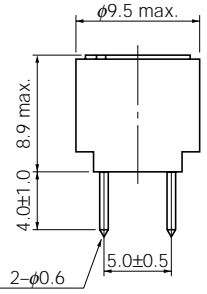
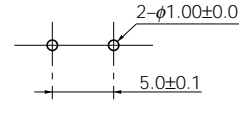
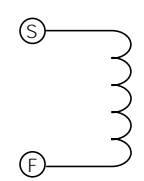
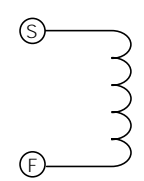

Examples Type 06D

	Part No.	Inductance (μH)	Tolerance (%)	Test Freq. (kHz)	R _{DC} (Ω) [at 20 °C] ** (Tol. ±30 %) (Tol. ±20 %)	*I _{DC} . [at 20 °C] (A) max.			
[Dimensions in mm] (not to scale) 	ELC06D2R2E	2.2	±20	10	**0.026	3.400			
	ELC06D2R7E	2.7			**0.028	3.200			
	ELC06D3R3E	3.3			**0.027	3.000			
	ELC06D3R9E	3.9			**0.030	2.800			
	ELC06D4R7E	4.7			**0.033	2.600			
	ELC06D5R6E	5.6			**0.035	2.400			
	ELC06D6R8E	6.8			0.041	2.000			
	ELC06D8R2E	8.2			0.048	1.800			
	ELC06D100E	10.0			0.052	1.700			
	ELC06D120E	12.0			0.054	1.650			
	ELC06D150E	15.0			0.059	1.500			
	ELC06D180E	18.0			0.065	1.250			
	Recommended PWB piercing plan 	ELC06D220E			22.0	±10	10	0.076	1.200
		ELC06D270E			27.0			0.083	0.950
ELC06D330E		33.0	0.100	0.900					
ELC06D390E		39.0	0.105	0.850					
ELC06D470E		47.0	0.120	0.800					
ELC06D560E		56.0	0.140	0.750					
ELC06D680E		68.0	0.150	0.700					
ELC06D820E		82.0	0.210	0.550					
ELC06D101E		100.0	0.230	0.500					
ELC06D121E		120.0	0.260	0.490					
ELC06D151E		150.0	0.370	0.450					
ELC06D181E		180.0	0.420	0.400					
ELC06D221E		220.0	0.550	0.360					
ELC06D271E		270.0	0.650	0.350					
ELC06D331E		330.0	0.740	0.300					
ELC06D391E		390.0	0.950	0.270					
ELC06D471E		470.0	1.080	0.240					
ELC06D561E		560.0	1.220	0.220					
Connection Schematic 		ELC06D681E	680.0					1.590	0.210
		ELC06D821E	820.0					1.760	0.180
	ELC06D102E	1000.0			2.490	0.160			
	ELC06D122E	1200.0			2.760	0.150			
	ELC06D152E	1500.0			3.240	0.130			
	ELC06D182E	1800.0			4.560	0.120			
	ELC06D222E	2200.0			5.180	0.110			
	ELC06D272E	2700.0			6.080	0.100			
	ELC06D332E	3300.0			8.800	0.100			
	ELC06D392E	3900.0			9.470	0.080			
ELC06D472E	4700.0			10.900	0.075				
ELC06D562E	5600.0			12.300	0.070				

* Allowable DC Current: Smaller current value either when the inductance is -10 % or when the case temperature has risen 45 °C.

Examples Type 09D

	Part No.	Inductance (μH)	Tolerance (%)	Test Freq. (kHz)	R _{DC} (Ω) [at 20 °C] ** (Tol. ±30 %) (Tol. ±20 %)	*I _{DC} . [at 20 °C] (A) max.
[Dimensions in mm] (not to scale) 	ELC09D2R2□F	2.2	±20	10	0.012	3.50
	ELC09D2R7□F	2.7			0.013	3.30
	ELC09D3R3□F	3.3			0.015	3.20
	ELC09D3R9□F	3.9			0.016	3.10
	ELC09D4R7□F	4.7			0.018	3.00
	ELC09D5R6□F	5.6			0.019	2.90
	ELC09D6R8□F	6.8			0.021	2.80
	ELC09D8R2□F	8.2			0.024	2.60
	ELC09D100□F	10.0			0.027	2.50
	ELC09D120□F	12.0			0.031	2.30
	ELC09D150□F	15.0			0.035	2.10
	ELC09D180□F	18.0			0.038	2.00
 Recommended PWB piercing plan 	ELC09D220□F	22.0	±10	10	0.051	1.80
	ELC09D270□F	27.0			0.058	1.60
	ELC09D330□F	33.0			0.081	1.40
	ELC09D390□F	39.0			0.087	1.30
	ELC09D470□F	47.0			0.110	1.20
	ELC09D560□F	56.0			0.130	1.10
	ELC09D680□F	68.0			0.140	1.00
	ELC09D820□F	82.0			0.160	0.90
	ELC09D101□F	100.0			0.200	0.82
	ELC09D121□F	120.0			0.250	0.77
	ELC09D151□F	150.0			0.320	0.74
	ELC09D181□F	180.0			0.360	0.61
Connection Schematic 	ELC09D221□F	220.0	±10	10	0.410	0.58
	ELC09D271□F	270.0			0.500	0.52
	ELC09D331□F	330.0			0.650	0.49
	ELC09D391□F	390.0			0.860	0.46
	ELC09D471□F	470.0			0.980	0.39
	ELC09D561□F	560.0			1.100	0.36
	ELC09D681□F	680.0			1.400	0.34
	ELC09D821□F	820.0			1.600	0.30
	ELC09D102□F	1000.0			2.100	0.28
	ELC09D122□F	1200.0			2.400	0.23
	ELC09D152□F	1500.0			2.800	0.21
	ELC09D182□F	1800.0			3.800	0.19
ELC09D222□F	2200.0	4.400	0.17			
ELC09D272□F	2700.0	6.100	0.16			
ELC09D332□F	3300.0	7.000	0.14			
ELC09D392□F	3900.0	8.000	0.13			
ELC09D472□F	4700.0	11.200	0.12			
ELC09D562□F	5600.0	12.600	0.11			
ELC09D682□F	6800.0	14.400	0.10			
ELC09D822□F	8200.0	16.600	0.09			
ELC09D103□F	10000.0	18.800	0.08			

* Allowable DC Current: Smaller current value either when the inductance is -10 % or when the case temperature has risen 45 °C.

Design and specifications are each subject to change without notice. Ask factory for the current technical specifications before purchase and/or use. Should a safety concern arise regarding this product, please be sure to contact us immediately.

Examples Type 10D

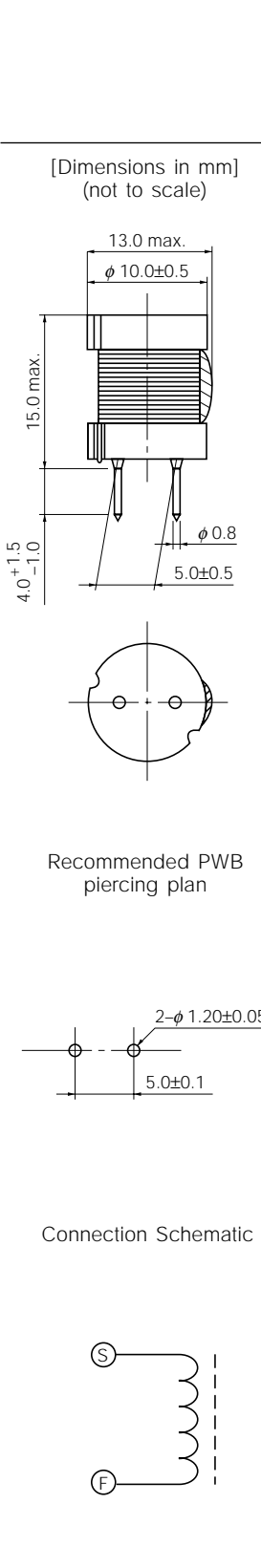
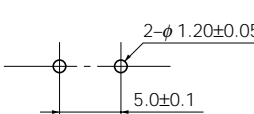
	Part No.	Inductance (μH)	Tolerance (%)	Test Freq. (kHz)	R _{DC} (Ω) [at 20 °C] (Tol. ±20 %)	*I _{DC} [at 20 °C] (A) max.
<p>[Dimensions in mm] (not to scale)</p>  <p>Recommended PWB piercing plan</p> <p>Connection Schematic</p> 	ELC10D2R2E	2.2	±20	10	0.014	5.90
	ELC10D2R7E	2.7			0.015	5.50
	ELC10D3R3E	3.3			0.016	5.20
	ELC10D3R9E	3.9			0.018	4.80
	ELC10D4R7E	4.7			0.019	4.60
	ELC10D5R6E	5.6			0.021	4.30
	ELC10D6R8E	6.8			0.022	4.20
	ELC10D8R2E	8.2			0.024	4.00
	ELC10D100E	10.0			0.026	3.90
	ELC10D120E	12.0			0.028	3.80
	ELC10D150E	15.0			0.033	3.50
	ELC10D180E	18.0			0.036	3.40
	ELC10D220E	22.0			0.040	3.20
	ELC10D270E	27.0			0.044	3.00
	ELC10D330E	33.0			0.051	2.80
	ELC10D390E	39.0	0.054		2.70	
	ELC10D470E	47.0	0.060		2.50	
	ELC10D560E	56.0	0.067		2.30	
	ELC10D680E	68.0	0.075		2.10	
	ELC10D820E	82.0	0.095		1.80	
	ELC10D101E	100.0	0.110		1.70	
	ELC10D121E	120.0	0.120		1.60	
	ELC10D151E	150.0	0.160		1.40	
	ELC10D181E	180.0	0.180		1.30	
	ELC10D221E	220.0	0.210		1.10	
	ELC10D271E	270.0	0.280		1.00	
	ELC10D331E	330.0	0.320		0.90	
	ELC10D391E	390.0	0.400		0.80	
	ELC10D471E	470.0	0.450		0.70	
	ELC10D561E	560.0	0.560		0.68	
	ELC10D681E	680.0	0.660		0.64	
	ELC10D821E	820.0	0.800		0.55	
	ELC10D102E	1000.0	1.000		0.50	
ELC10D122E	1200.0	1.200	0.45			
ELC10D152E	1500.0	1.500	0.42			
ELC10D182E	1800.0	1.800	0.40			
ELC10D222E	2200.0	2.100	0.36			
ELC10D272E	2700.0	2.700	0.32			
ELC10D332E	3300.0	3.200	0.28			
ELC10D392E	3900.0	3.500	0.26			
			±10			

* Allowable DC Current: Smaller current value either when the inductance is -10 % or when the case temperature has risen 45 °C.

Examples Type 11D

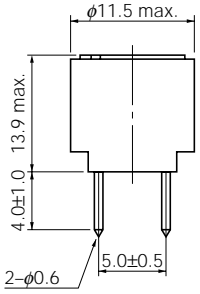
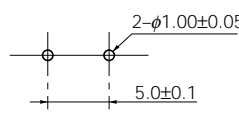
	Part No.	Inductance (μH)	Tolerance (%)	Test Freq. (kHz)	R _{DC} (Ω) [at 20 °C] (Tol.±20 %)	*I _{DC} [at 20 °C] (A)max.
[Dimensions in mm] (not to scale) 	ELC11D2R2F	2.2	±20	10	0.013	5.30
	ELC11D2R7F	2.7			0.014	5.10
	ELC11D3R3F	3.3			0.015	4.90
	ELC11D3R9F	3.9			0.016	4.80
	ELC11D4R7F	4.7			0.018	4.70
	ELC11D5R6F	5.6			0.020	4.60
	ELC11D6R8F	6.8			0.022	4.40
	ELC11D8R2F	8.2			0.024	3.90
	ELC11D100F	10.0			0.029	3.50
	ELC11D120F	12.0			0.030	3.40
	ELC11D150F	15.0			0.033	3.30
	ELC11D180F	18.0			0.037	3.10
	ELC11D220F	22.0			0.040	2.80
	ELC11D270F	27.0			0.048	2.70
	ELC11D330F	33.0			0.051	2.60
	ELC11D390F	39.0			0.057	2.50
	ELC11D470F	47.0			0.063	2.30
	ELC11D560F	56.0			0.071	2.10
	ELC11D680F	68.0			0.082	2.00
	Recommended PWB piercing plan 	ELC11D820F			82.0	±10
ELC11D101F		100.0	0.120	1.80		
ELC11D121F		120.0	0.160	1.60		
ELC11D151F		150.0	0.180	1.40		
ELC11D181F		180.0	0.200	1.30		
ELC11D221F		220.0	0.230	1.20		
ELC11D271F		270.0	0.320	1.10		
ELC11D331F		330.0	0.350	1.00		
ELC11D391F		390.0	0.400	0.95		
ELC11D471F		470.0	0.490	0.82		
ELC11D561F		560.0	0.620	0.73		
ELC11D681F		680.0	0.780	0.64		
ELC11D821F		820.0	0.870	0.62		
ELC11D102F		1000.0	1.100	0.57		
ELC11D122F		1200.0	1.200	0.52		
ELC11D152F		1500.0	1.700	0.43		
ELC11D182F		1800.0	2.000	0.40		
ELC11D222F		2200.0	2.300	0.38		
ELC11D272F		2700.0	2.800	0.34		
ELC11D332F		3300.0	3.600	0.31		
ELC11D392F	3900.0	4.500	0.29			
ELC11D472F	4700.0	5.200	0.26			
ELC11D562F	5600.0	6.900	0.23			
ELC11D682F	6800.0	7.800	0.21			
ELC11D822F	8200.0	10.600	0.18			
ELC11D103F	10000.0	11.800	0.16			

Recommended PWB piercing plan

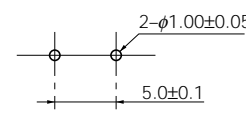

Connection Schematic

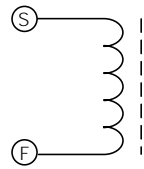

* Allowable DC Current: Smaller current value either when the inductance is -10 % or when the case temperature has risen 45 °C.

Design and specifications are each subject to change without notice. Ask factory for the current technical specifications before purchase and/or use. Should a safety concern arise regarding this product, please be sure to contact us immediately.

Examples Type 11P

	Part No.	Inductance (μH)	Tolerance (%)	Test Freq. (kHz)	R _{DC} (Ω) [at 20 °C] (Tol. ±20 %)	*I _{DC} [at 20 °C] (A) max.	φA Terminal Pin (mm)
<p>[Dimensions in mm] (not to scale)</p> <p>Recommended PWB piercing plan</p> <p>*1 9.0±0.1</p> <p>*2 2-φ1.50±0.05</p> <p>*3 9.0±0.1</p>	ELC11PR35	0.35	±20	10	0.0014	14.0	φ1.05
	ELC11P0R6	0.60			0.0018	13.0	
	ELC11P1R0	1.00			0.0023	12.0	
	ELC11P1R4	1.40			0.0028	11.0	
	ELC11P1R8	1.80			0.0033	10.0	
	ELC11P2R4	2.40			0.0038	9.60	
	ELC11P3R0	3.00			0.0044	9.20	
	ELC11P3R9	3.90			0.0049	8.60	
	ELC11P4R7	4.70			0.0055	8.20	
	ELC11P5R6	5.60			0.0061	7.80	
	ELC11P6R8	6.80			0.0087	7.40	
	ELC11P7R8	7.80			0.0094	7.00	φ0.90
	ELC11P9R1	9.10			0.0124	6.60	
	ELC11P100	10.0			0.0132	6.30	
	ELC11P120	12.0			0.0140	6.00	φ0.80

* Allowable DC Current: Smaller current value either when the inductance is -10 % or when the case temperature has risen 45 °C. The measure of *1, *2, *3 differ depending on the terminal size φA. (The recommended drawing shows the φ1.05.)

Examples Type 12D

	Part No.	Inductance (μH)	Tolerance (%)	Test Freq. (kHz)	R _{DC} (Ω) [at 20 °C] (Tol. ±20 %)	*I _{DC} [at 20 °C] (A) max.
<p>[Dimensions in mm] (not to scale)</p> <p>Recommended PWB piercing plan</p> <p>2-φ1.20±0.05</p> <p>7.5±0.5</p> <p>Connection Schematic</p>	ELC12D101E	100	±10	10	0.150	1.90
	ELC12D121E	120			0.170	1.78
	ELC12D151E	150			0.190	1.67
	ELC12D181E	180			0.210	1.58
	ELC12D221E	220			0.230	1.55
	ELC12D271E	270			0.270	1.44
	ELC12D331E	330			0.300	1.34
	ELC12D391E	390			0.330	1.32
	ELC12D471E	470			0.380	1.25
	ELC12D561E	560			0.420	1.15
	ELC12D681E	680			0.460	0.98
	ELC12D821E	820			0.650	0.94
	ELC12D102E	1000			0.720	0.87
	ELC12D122E	1200			0.830	0.86
	ELC12D152E	1500			1.270	0.64
	ELC12D182E	1800			1.330	0.63
	ELC12D222E	2200			1.500	0.60
	ELC12D272E	2700			1.890	0.54
	ELC12D332E	3300			2.370	0.48
	ELC12D392E	3900			2.830	0.45
ELC12D472E	4700	3.190	0.41			
ELC12D562E	5600	4.080	0.34			
ELC12D682E	6800	5.740	0.29			
ELC12D822E	8200	6.340	0.28			
ELC12D103E	10000	7.200	0.27			

* Allowable DC Current: Smaller current value either when the inductance is -10 % or when the case temperature has risen 45 °C.

Design and specifications are each subject to change without notice. Ask factory for the current technical specifications before purchase and/or use. Should a safety concern arise regarding this product, please be sure to contact us immediately.

Examples Type 16B

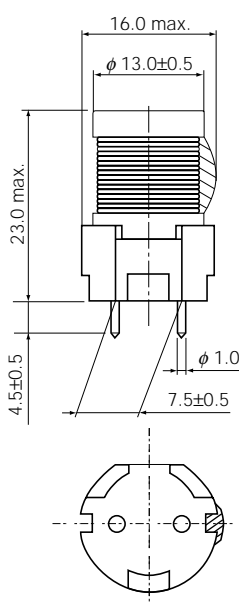
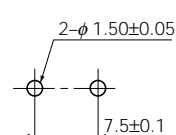
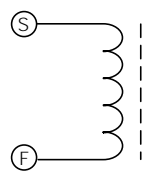
	Part No.	Inductance (μH)	Tolerance (%)	Test Freq. (kHz)	R _{DC} (Ω) [at 20 °C] ** (Tol. ±30 %) (Tol. ±20 %)	*I _{DC} . [at 20 °C] (A) max.
<p>[Dimensions in mm] (not to scale)</p>  <p>Recommended PWB piercing plan</p>  <p>Connection Schematic</p> 	ELC16B3R3L	3.3	±25	10	**0.012	8.50
	ELC16B3R9L	3.9			**0.013	8.00
	ELC16B4R7L	4.7			**0.015	7.80
	ELC16B5R6L	5.6	±20		**0.016	7.40
	ELC16B6R8L	6.8			0.018	6.70
	ELC16B8R2L	8.2			0.019	6.10
	ELC16B100L	10.0			0.022	5.60
	ELC16B120L	12.0			0.023	5.50
	ELC16B150L	15.0			0.026	5.40
	ELC16B180L	18.0			0.028	5.10
	ELC16B220L	22.0			0.031	4.60
	ELC16B270L	27.0			0.034	4.30
	ELC16B330L	33.0			0.039	4.00
	ELC16B390L	39.0	±10		0.042	3.90
	ELC16B470L	47.0			0.045	3.80
	ELC16B560L	56.0			0.051	3.40
	ELC16B680L	68.0			0.057	3.20
	ELC16B820L	82.0			0.064	3.00
	ELC16B101L	100.0			0.072	2.60
	ELC16B121L	120.0			0.080	2.50
	ELC16B151L	150.0			0.103	2.20
	ELC16B181L	180.0			0.115	2.10
	ELC16B221L	220.0			0.130	1.90
	ELC16B271L	270.0	0.170		1.60	
	ELC16B331L	330.0	±10		0.200	1.50
	ELC16B391L	390.0			0.250	1.30
	ELC16B471L	470.0			0.280	1.20
	ELC16B561L	560.0			0.380	1.10
	ELC16B681L	680.0			0.430	1.00
	ELC16B821L	820.0			0.580	0.88
	ELC16B102L	1000.0			0.660	0.85
	ELC16B122L	1200.0			0.740	0.82
	ELC16B152L	1500.0			0.870	0.74
ELC16B182L	1800.0	1.220		0.60		
ELC16B222L	2200.0	1.380	0.57			
ELC16B272L	2700.0	1.570	0.54			
ELC16B332L	3300.0	2.000	0.47			
ELC16B392L	3900.0	2.400	0.42			
ELC16B472L	4700.0	3.300	0.36			
ELC16B562L	5600.0	3.700	0.34			
ELC16B682L	6800.0	4.200	0.32			
ELC16B822L	8200.0	5.600	0.28			
ELC16B103L	10000.0	6.400	0.26			

* Allowable DC Current: Smaller current value either when the inductance is -10 % or when the case temperature has risen 45 °C.

Design and specifications are each subject to change without notice. Ask factory for the current technical specifications before purchase and/or use. Should a safety concern arise regarding this product, please be sure to contact us immediately.

Feb. 2006

Examples Type 18B

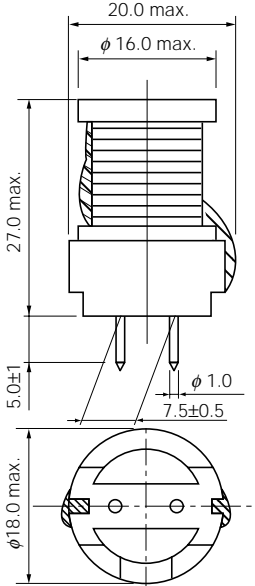
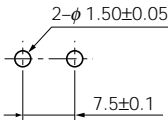
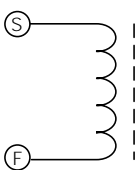
	Part No.	Inductance (μH)	Tolerance (%)	Test Freq. (kHz)	R _{DC} (Ω) [at 20 °C] (Tol.±20 %)	*I _{DC} [at 20 °C] (A)max.
<p>[Dimensions in mm] (not to scale)</p>  <p>Recommended PWB piercing plan</p>  <p>Connection Schematic</p> 	ELC18B3R3L	3.3	±20	10	0.010	8.50
	ELC18B3R9L	3.9			0.011	8.00
	ELC18B4R7L	4.7			0.012	7.80
	ELC18B5R6L	5.6			0.013	7.40
	ELC18B6R8L	6.8			0.015	6.80
	ELC18B8R2L	8.2			0.016	6.60
	ELC18B100L	10.0			0.017	6.50
	ELC18B120L	12.0			0.018	6.00
	ELC18B150L	15.0			0.021	5.90
	ELC18B180L	18.0			0.022	5.60
	ELC18B220L	22.0			0.025	5.40
	ELC18B270L	27.0			0.028	4.80
	ELC18B330L	33.0			0.030	4.60
	ELC18B390L	39.0			0.033	4.40
	ELC18B470L	47.0			0.037	4.30
	ELC18B560L	56.0	0.040		4.20	
	ELC18B680L	68.0	0.046		4.00	
	ELC18B820L	82.0	0.051		3.70	
	ELC18B101L	100.0	0.057		3.20	
	ELC18B121L	120.0	0.065		3.00	
	ELC18B151L	150.0	0.072		2.70	
	ELC18B181L	180.0	0.082		2.60	
	ELC18B221L	220.0	0.090		2.40	
	ELC18B271L	270.0	0.110		2.20	
	ELC18B331L	330.0	0.130		1.90	
	ELC18B391L	390.0	0.150		1.80	
	ELC18B471L	470.0	0.210		1.60	
	ELC18B561L	560.0	0.230		1.50	
	ELC18B681L	680.0	0.260		1.40	
	ELC18B821L	820.0	0.340		1.30	
	ELC18B102L	1000.0	0.390		1.10	
	ELC18B122L	1200.0	0.440		1.00	
	ELC18B152L	1500.0	0.580		0.85	
ELC18B182L	1800.0	0.650	0.84			
ELC18B222L	2200.0	0.880	0.75			
ELC18B272L	2700.0	1.200	0.68			
ELC18B332L	3300.0	1.400	0.60			
ELC18B392L	3900.0	1.500	0.57			
ELC18B472L	4700.0	1.700	0.55			
ELC18B562L	5600.0	2.200	0.46			
ELC18B682L	6800.0	2.800	0.45			
ELC18B822L	8200.0	3.100	0.41			
ELC18B103L	10000.0	3.900	0.36			

* Allowable DC Current: Smaller current value either when the inductance is -10 % or when the case temperature has risen 45 °C.

单击下面可查看定价，库存，交付和生命周期等信息

[>>Panasonic\(松下\)](#)