

■ Pin Descriptions

Pin No.	Description
1	Input voltage pin (V_{IN})
2	Control pin (Cont.) High: operation, Low: stop
3	Grounding pin (GND) Electrically in common with radiation fin
4	Noise reduction pin (N.R.) Open when the noise reduction function is not used
5	Output voltage pin (V_{OUT})

■ Absolute Maximum Ratings

Parameter	Symbol	Rating	Unit
Supply voltage	V_{CC}	14.4	V
Supply current	I_{CC}	—	mA
Power dissipation ^{*1}	P_D	255	mW
Operating ambient temperature ^{*2}	T_{opr}	-30 to +85	°C
Storage temperature ^{*2}	T_{stg}	-55 to +150	°C

Note) 1. The output voltage may exceed the rated value if $T_j > 150^\circ\text{C}$ in no-load condition. Set to $I_O > 5\text{ mA}$ if T_j is likely to exceed 150°C .

2. This IC is not suitable for automobile equipment use.

3. *1: The above power dissipation shows the value of an independent IC without heat sink at $T_a = 85^\circ\text{C}$. For details, refer to "2. Power dissipation of SP-5SU package" in the Application Notes.

*2: Except for the operating ambient temperature and storage temperature, all ratings are for $T_a = 25^\circ\text{C}$.

■ Recommended Operating Conditions

Part No.	Output voltage	Operating supply voltage range (V_{CC})	Unit
AN80M18RSP	1.8	2.3 to 14.0	V
AN80M19RSP	1.9	2.4 to 14.0	V
AN80M20RSP	2.0	2.5 to 14.0	V
AN80M21RSP	2.1	2.6 to 14.0	V
AN80M22RSP	2.2	2.7 to 14.0	V
AN80M25RSP	2.5	3.0 to 14.0	V
AN80M27RSP	2.7	3.2 to 14.0	V
AN80M28RSP	2.8	3.3 to 14.0	V
AN80M29RSP	2.9	3.4 to 14.0	V
AN80M30RSP	3.0	3.5 to 14.0	V
AN80M31RSP	3.1	3.6 to 14.0	V
AN80M32RSP	3.2	3.7 to 14.0	V
AN80M33RSP	3.3	3.8 to 14.0	V
AN80M34RSP	3.4	3.9 to 14.0	V
AN80M35RSP	3.5	4.0 to 14.0	V
AN80M36RSP	3.6	4.1 to 14.0	V
AN80M48RSP	4.8	5.3 to 14.0	V
AN80M49RSP	4.9	5.4 to 14.0	V
AN80M50RSP	5.0	5.5 to 14.0	V
AN80M51RSP	5.1	5.6 to 14.0	V
AN80M52RSP	5.2	5.7 to 14.0	V
AN80M53RSP	5.3	5.8 to 14.0	V

■ Electrical Characteristics at $T_a = 25^\circ\text{C}$

• AN80M18RSP (1.8 V type)

Unless otherwise specially provided, shorten each test time (within 10 ms) so that the test is conducted under the condition that the drift due to the temperature increase in the chip junction part can be neglected. $C_{IN} = 3.3 \mu\text{F}$, $CNR = \text{Open}$, $C_{OUT} = 33 \mu\text{F}$

Parameter	Symbol	Conditions	Min	Typ	Max	Unit
Output voltage	V_{OUT}	$V_{IN} = 2.8 \text{ V}$, $I_{OUT} = 250 \text{ mA}$	1.746	1.8	1.854	V
Line regulation	REG_{IN}	$V_{IN} = 2.8 \text{ V} \rightarrow 14.0 \text{ V}$, $I_{OUT} = 250 \text{ mA}$	—	—	18	mV
Load regulation	REG_{LOA}	$V_{IN} = 2.8 \text{ V}$, $I_{OUT} = 0 \text{ mA} \rightarrow 500 \text{ mA}$	—	—	36	mV
Peak output current	I_{PEAK}	$V_{IN} = 2.8 \text{ V}$, The output current value when V_{OUT} decreases by 5% from its value at $I_{OUT} = 250 \text{ mA}$.	600	900	—	mA
Bias current under no load	I_{BIAS}	$V_{IN} = 2.8 \text{ V}$, $I_{OUT} = 0 \text{ mA}$	—	1.1	3.0	mA
Bias current fluctuation to input	$\Delta I_{BIAS(IN)}$	$V_{IN} = 2.8 \text{ V} \rightarrow 14.0 \text{ V}$, $I_{OUT} = 250 \text{ mA}$	-5	—	5	mA
Bias current fluctuation to load	$\Delta I_{BIAS(LOA)}$	$V_{IN} = 2.8 \text{ V}$, $I_{OUT} = 0 \text{ mA} \rightarrow 500 \text{ mA}$	—	—	25	mA
Standby consumption current	I_{STB}	$V_{IN} = 14.0 \text{ V}$, $V_{CONT} = 0 \text{ V}$	—	—	3.0	μA
Bias current before starting regulation	I_{RUSH}	$V_{IN} = 1.71 \text{ V}$, $I_{OUT} = 0 \text{ A}$	—	—	5	mA
Control terminal current	I_{CONT}	$V_{IN} = 2.8 \text{ V}$, $I_{OUT} = 250 \text{ mA}$ $V_{CONT} = 1.8 \text{ V}$	—	—	30	μA
Ripple rejection ratio 1	RR1	$V_{IN} = 3.8 \text{ V} \pm 1 \text{ V}$, $f = 120 \text{ Hz}$ $I_{OUT} = 100 \text{ mA}$	58.8	—	—	dB
Minimum input/output voltage difference 1	$V_{DIF(min)1}$	$V_{IN} = 1.9 \text{ V}$, $I_{OUT} = 250 \text{ mA}$	—	0.25	0.45	V
Minimum input/output voltage difference 2	$V_{DIF(min)2}$	$V_{IN} = 2.0 \text{ V}$, $I_{OUT} = 500 \text{ mA}$	—	—	0.8	V
Control terminal threshold high voltage	V_{CONTH}	$V_{IN} = 2.8 \text{ V}$	—	1.45	1.80	V
Control terminal threshold low voltage	V_{CONTL}	$V_{IN} = 2.8 \text{ V}$	0.50	0.70	—	V

• Design reference data

Note) The following values are typical and not guaranteed values.

Parameter	Symbol	Conditions	Min	Typ	Max	Unit
Ripple rejection ratio 2	RR2	$V_{IN} = 3.8 \text{ V} \pm 1 \text{ V}$, $f = 500 \text{ kHz}$ $I_{OUT} = 100 \text{ mA}$	—	30	—	dB
Output noise voltage	V_{NO}	$10 \text{ Hz} \leq f \leq 100 \text{ kHz}$, $I_{OUT} = 100 \text{ mA}$ $V_{IN} = 2.8 \text{ V}$, $CNR = 1 \mu\text{F}$	—	40	—	$\mu\text{V[rms]}$
Output voltage temperature coefficient	$\frac{dV_{OUT}}{dT_a}$	$V_{IN} = 2.8 \text{ V}$, $I_{OUT} = 5 \text{ mA}$ $-30^\circ\text{C} \leq T_a \leq +125^\circ\text{C}$	—	± 40	—	ppm/ $^\circ\text{C}$
Output short-circuit current	I_{OSHORT}	$V_{IN} = 14.0 \text{ V}$, $V_{OUT} = \text{GND}$	—	300	—	mA
Overheat protection operating temperature	T_{JTH}	$V_{IN} = 2.8 \text{ V}$, $I_{OUT} = 5 \text{ mA}$	—	150	—	$^\circ\text{C}$

■ Electrical Characteristics at $T_a = 25^\circ\text{C}$ (continued)

• AN80M19RSP (1.9 V type)

Unless otherwise specially provided, shorten each test time (within 10 ms) so that the test is conducted under the condition that the drift due to the temperature increase in the chip junction part can be neglected. $C_{IN} = 3.3 \mu\text{F}$, $CNR = \text{Open}$, $C_{OUT} = 33 \mu\text{F}$

Parameter	Symbol	Conditions	Min	Typ	Max	Unit
Output voltage	V_{OUT}	$V_{IN} = 2.9 \text{ V}$, $I_{OUT} = 250 \text{ mA}$	1.843	1.9	1.957	V
Line regulation	REG_{IN}	$V_{IN} = 2.9 \text{ V} \rightarrow 14.0 \text{ V}$, $I_{OUT} = 250 \text{ mA}$	—	—	19	mV
Load regulation	REG_{LOA}	$V_{IN} = 2.9 \text{ V}$, $I_{OUT} = 0 \text{ mA} \rightarrow 500 \text{ mA}$	—	—	38	mV
Peak output current	I_{PEAK}	$V_{IN} = 2.9 \text{ V}$, The output current value when V_{OUT} decreases by 5% from its value at $I_{OUT} = 250 \text{ mA}$.	600	900	—	mA
Bias current under no load	I_{BIAS}	$V_{IN} = 2.9 \text{ V}$, $I_{OUT} = 0 \text{ mA}$	—	1.1	3.0	mA
Bias current fluctuation to input	$\Delta I_{BIAS(IN)}$	$V_{IN} = 2.9 \text{ V} \rightarrow 14.0 \text{ V}$, $I_{OUT} = 250 \text{ mA}$	-5	—	5	mA
Bias current fluctuation to load	$\Delta I_{BIAS(LOA)}$	$V_{IN} = 2.9 \text{ V}$, $I_{OUT} = 0 \text{ mA} \rightarrow 500 \text{ mA}$	—	—	25	mA
Standby consumption current	I_{STB}	$V_{IN} = 14.0 \text{ V}$, $V_{CONT} = 0 \text{ V}$	—	—	3.0	μA
Bias current before starting regulation	I_{RUSH}	$V_{IN} = 1.805 \text{ V}$, $I_{OUT} = 0 \text{ A}$	—	—	5	mA
Control terminal current	I_{CONT}	$V_{IN} = 2.9 \text{ V}$, $I_{OUT} = 250 \text{ mA}$ $V_{CONT} = 1.8 \text{ V}$	—	—	30	μA
Ripple rejection ratio 1	RR1	$V_{IN} = 3.9 \text{ V} \pm 1 \text{ V}$, $f = 120 \text{ Hz}$ $I_{OUT} = 100 \text{ mA}$	58.4	—	—	dB
Minimum input/output voltage difference 1	$V_{DIF(min)1}$	$V_{IN} = 2.0 \text{ V}$, $I_{OUT} = 250 \text{ mA}$	—	0.25	0.45	V
Minimum input/output voltage difference 2	$V_{DIF(min)2}$	$V_{IN} = 2.1 \text{ V}$, $I_{OUT} = 500 \text{ mA}$	—	—	0.8	V
Control terminal threshold high voltage	V_{CONTH}	$V_{IN} = 2.9 \text{ V}$	—	1.45	1.80	V
Control terminal threshold low voltage	V_{CONTL}	$V_{IN} = 2.9 \text{ V}$	0.50	0.70	—	V

• Design reference data

Note) The following values are typical and not guaranteed values.

Parameter	Symbol	Conditions	Min	Typ	Max	Unit
Ripple rejection ratio 2	RR2	$V_{IN} = 3.9 \text{ V} \pm 1 \text{ V}$, $f = 500 \text{ kHz}$ $I_{OUT} = 100 \text{ mA}$	—	30	—	dB
Output noise voltage	V_{NO}	$10 \text{ Hz} \leq f \leq 100 \text{ kHz}$, $I_{OUT} = 100 \text{ mA}$ $V_{IN} = 2.9 \text{ V}$, $CNR = 1 \mu\text{F}$	—	40	—	$\mu\text{V[rms]}$
Output voltage temperature coefficient	$\frac{dV_{OUT}}{dT_a}$	$V_{IN} = 2.9 \text{ V}$, $I_{OUT} = 5 \text{ mA}$ $-30^\circ\text{C} \leq T_a \leq +125^\circ\text{C}$	—	± 40	—	ppm/ $^\circ\text{C}$
Output short-circuit current	I_{OSHORT}	$V_{IN} = 14.0 \text{ V}$, $V_{OUT} = \text{GND}$	—	300	—	mA
Overheat protection operating temperature	T_{JTH}	$V_{IN} = 2.9 \text{ V}$, $I_{OUT} = 5 \text{ mA}$	—	150	—	$^\circ\text{C}$

■ Electrical Characteristics at $T_a = 25^\circ\text{C}$ (continued)

• AN80M20RSP (2.0 V type)

Unless otherwise specially provided, shorten each test time (within 10 ms) so that the test is conducted under the condition that the drift due to the temperature increase in the chip junction part can be neglected. $C_{IN} = 3.3 \mu\text{F}$, $CNR = \text{Open}$, $C_{OUT} = 33 \mu\text{F}$

Parameter	Symbol	Conditions	Min	Typ	Max	Unit
Output voltage	V_{OUT}	$V_{IN} = 3.0 \text{ V}$, $I_{OUT} = 250 \text{ mA}$	1.940	2.0	2.060	V
Line regulation	REG_{IN}	$V_{IN} = 3.0 \text{ V} \rightarrow 14.0 \text{ V}$, $I_{OUT} = 250 \text{ mA}$	—	—	20	mV
Load regulation	REG_{LOA}	$V_{IN} = 3.0 \text{ V}$, $I_{OUT} = 0 \text{ mA} \rightarrow 500 \text{ mA}$	—	—	40	mV
Peak output current	I_{PEAK}	$V_{IN} = 3.0 \text{ V}$, The output current value when V_{OUT} decreases by 5% from its value at $I_{OUT} = 250 \text{ mA}$.	600	900	—	mA
Bias current under no load	I_{BIAS}	$V_{IN} = 3.0 \text{ V}$, $I_{OUT} = 0 \text{ mA}$	—	1.1	3.0	mA
Bias current fluctuation to input	$\Delta I_{BIAS(IN)}$	$V_{IN} = 3.0 \text{ V} \rightarrow 14.0 \text{ V}$, $I_{OUT} = 250 \text{ mA}$	-5	—	5	mA
Bias current fluctuation to load	$\Delta I_{BIAS(LOA)}$	$V_{IN} = 3.0 \text{ V}$, $I_{OUT} = 0 \text{ mA} \rightarrow 500 \text{ mA}$	—	—	25	mA
Standby consumption current	I_{STB}	$V_{IN} = 14.0 \text{ V}$, $V_{CONT} = 0 \text{ V}$	—	—	3.0	μA
Bias current before starting regulation	I_{RUSH}	$V_{IN} = 1.90 \text{ V}$, $I_{OUT} = 0 \text{ A}$	—	—	5	mA
Control terminal current	I_{CONT}	$V_{IN} = 3.0 \text{ V}$, $I_{OUT} = 250 \text{ mA}$ $V_{CONT} = 1.8 \text{ V}$	—	—	30	μA
Ripple rejection ratio 1	RR1	$V_{IN} = 4.0 \text{ V} \pm 1 \text{ V}$, $f = 120 \text{ Hz}$ $I_{OUT} = 100 \text{ mA}$	57.9	—	—	dB
Minimum input/output voltage difference 1	$V_{DIF(min)1}$	$V_{IN} = 2.1 \text{ V}$, $I_{OUT} = 250 \text{ mA}$	—	0.25	0.45	V
Minimum input/output voltage difference 2	$V_{DIF(min)2}$	$V_{IN} = 2.2 \text{ V}$, $I_{OUT} = 500 \text{ mA}$	—	—	0.8	V
Control terminal threshold high voltage	V_{CONTH}	$V_{IN} = 3.0 \text{ V}$	—	1.45	1.80	V
Control terminal threshold low voltage	V_{CONTL}	$V_{IN} = 3.0 \text{ V}$	0.50	0.70	—	V

• Design reference data

Note) The following values are typical and not guaranteed values.

Parameter	Symbol	Conditions	Min	Typ	Max	Unit
Ripple rejection ratio 2	RR2	$V_{IN} = 4.0 \text{ V} \pm 1 \text{ V}$, $f = 500 \text{ kHz}$ $I_{OUT} = 100 \text{ mA}$	—	30	—	dB
Output noise voltage	V_{NO}	$10 \text{ Hz} \leq f \leq 100 \text{ kHz}$, $I_{OUT} = 100 \text{ mA}$ $V_{IN} = 3.0 \text{ V}$, $CNR = 1 \mu\text{F}$	—	40	—	$\mu\text{V[rms]}$
Output voltage temperature coefficient	$\frac{dV_{OUT}}{dT_a}$	$V_{IN} = 3.0 \text{ V}$, $I_{OUT} = 5 \text{ mA}$ $-30^\circ\text{C} \leq T_a \leq +125^\circ\text{C}$	—	± 40	—	ppm/ $^\circ\text{C}$
Output short-circuit current	I_{OSHORT}	$V_{IN} = 14.0 \text{ V}$, $V_{OUT} = \text{GND}$	—	300	—	mA
Overheat protection operating temperature	T_{JTH}	$V_{IN} = 3.0 \text{ V}$, $I_{OUT} = 5 \text{ mA}$	—	150	—	$^\circ\text{C}$

■ Electrical Characteristics at $T_a = 25^\circ\text{C}$ (continued)

• AN80M21RSP (2.1 V type)

Unless otherwise specially provided, shorten each test time (within 10 ms) so that the test is conducted under the condition that the drift due to the temperature increase in the chip junction part can be neglected. $C_{IN} = 3.3 \mu\text{F}$, $CNR = \text{Open}$, $C_{OUT} = 33 \mu\text{F}$

Parameter	Symbol	Conditions	Min	Typ	Max	Unit
Output voltage	V_{OUT}	$V_{IN} = 3.1 \text{ V}$, $I_{OUT} = 250 \text{ mA}$	2.037	2.1	2.163	V
Line regulation	REG_{IN}	$V_{IN} = 3.1 \text{ V} \rightarrow 14.0 \text{ V}$, $I_{OUT} = 250 \text{ mA}$	—	—	21	mV
Load regulation	REG_{LOA}	$V_{IN} = 3.1 \text{ V}$, $I_{OUT} = 0 \text{ mA} \rightarrow 500 \text{ mA}$	—	—	42	mV
Peak output current	I_{PEAK}	$V_{IN} = 3.1 \text{ V}$, The output current value when V_{OUT} decreases by 5% from its value at $I_{OUT} = 250 \text{ mA}$.	600	900	—	mA
Bias current under no load	I_{BIAS}	$V_{IN} = 3.1 \text{ V}$, $I_{OUT} = 0 \text{ mA}$	—	1.1	3.0	mA
Bias current fluctuation to input	$\Delta I_{BIAS(IN)}$	$V_{IN} = 3.1 \text{ V} \rightarrow 14.0 \text{ V}$, $I_{OUT} = 250 \text{ mA}$	-5	—	5	mA
Bias current fluctuation to load	$\Delta I_{BIAS(LOA)}$	$V_{IN} = 3.1 \text{ V}$, $I_{OUT} = 0 \text{ mA} \rightarrow 500 \text{ mA}$	—	—	25	mA
Standby consumption current	I_{STB}	$V_{IN} = 14.0 \text{ V}$, $V_{CONT} = 0 \text{ V}$	—	—	3.0	μA
Bias current before starting regulation	I_{RUSH}	$V_{IN} = 1.995 \text{ V}$, $I_{OUT} = 0 \text{ A}$	—	—	5	mA
Control terminal current	I_{CONT}	$V_{IN} = 3.1 \text{ V}$, $I_{OUT} = 250 \text{ mA}$ $V_{CONT} = 1.8 \text{ V}$	—	—	30	μA
Ripple rejection ratio 1	RR1	$V_{IN} = 4.1 \text{ V} \pm 1 \text{ V}$, $f = 120 \text{ Hz}$ $I_{OUT} = 100 \text{ mA}$	57.5	—	—	dB
Minimum input/output voltage difference 1	$V_{DIF(min)1}$	$V_{IN} = 2.2 \text{ V}$, $I_{OUT} = 250 \text{ mA}$	—	0.25	0.45	V
Minimum input/output voltage difference 2	$V_{DIF(min)2}$	$V_{IN} = 2.3 \text{ V}$, $I_{OUT} = 500 \text{ mA}$	—	—	0.8	V
Control terminal threshold high voltage	V_{CONTH}	$V_{IN} = 3.1 \text{ V}$	—	1.45	1.80	V
Control terminal threshold low voltage	V_{CONTL}	$V_{IN} = 3.1 \text{ V}$	0.50	0.70	—	V

• Design reference data

Note) The following values are typical and not guaranteed values.

Parameter	Symbol	Conditions	Min	Typ	Max	Unit
Ripple rejection ratio 2	RR2	$V_{IN} = 4.1 \text{ V} \pm 1 \text{ V}$, $f = 500 \text{ kHz}$ $I_{OUT} = 100 \text{ mA}$	—	30	—	dB
Output noise voltage	V_{NO}	$10 \text{ Hz} \leq f \leq 100 \text{ kHz}$, $I_{OUT} = 100 \text{ mA}$ $V_{IN} = 3.1 \text{ V}$, $CNR = 1 \mu\text{F}$	—	40	—	$\mu\text{V[rms]}$
Output voltage temperature coefficient	$\frac{dV_{OUT}}{dT_a}$	$V_{IN} = 3.1 \text{ V}$, $I_{OUT} = 5 \text{ mA}$ $-30^\circ\text{C} \leq T_a \leq +125^\circ\text{C}$	—	± 40	—	ppm/ $^\circ\text{C}$
Output short-circuit current	I_{OSHORT}	$V_{IN} = 14.0 \text{ V}$, $V_{OUT} = \text{GND}$	—	300	—	mA
Overheat protection operating temperature	T_{JTH}	$V_{IN} = 3.1 \text{ V}$, $I_{OUT} = 5 \text{ mA}$	—	150	—	$^\circ\text{C}$

■ Electrical Characteristics at $T_a = 25^\circ\text{C}$ (continued)

• AN80M22RSP (2.2 V type)

Unless otherwise specially provided, shorten each test time (within 10 ms) so that the test is conducted under the condition that the drift due to the temperature increase in the chip junction part can be neglected. $C_{IN} = 3.3 \mu\text{F}$, $CNR = \text{Open}$, $C_{OUT} = 33 \mu\text{F}$

Parameter	Symbol	Conditions	Min	Typ	Max	Unit
Output voltage	V_{OUT}	$V_{IN} = 3.2 \text{ V}$, $I_{OUT} = 250 \text{ mA}$	2.134	2.2	2.266	V
Line regulation	REG_{IN}	$V_{IN} = 3.2 \text{ V} \rightarrow 14.0 \text{ V}$, $I_{OUT} = 250 \text{ mA}$	—	—	22	mV
Load regulation	REG_{LOA}	$V_{IN} = 3.2 \text{ V}$, $I_{OUT} = 0 \text{ mA} \rightarrow 500 \text{ mA}$	—	—	44	mV
Peak output current	I_{PEAK}	$V_{IN} = 3.2 \text{ V}$, The output current value when V_{OUT} decreases by 5% from its value at $I_{OUT} = 250 \text{ mA}$.	600	900	—	mA
Bias current under no load	I_{BIAS}	$V_{IN} = 3.2 \text{ V}$, $I_{OUT} = 0 \text{ mA}$	—	1.1	3.0	mA
Bias current fluctuation to input	$\Delta I_{BIAS(IN)}$	$V_{IN} = 3.2 \text{ V} \rightarrow 14.0 \text{ V}$, $I_{OUT} = 250 \text{ mA}$	-5	—	5	mA
Bias current fluctuation to load	$\Delta I_{BIAS(LOA)}$	$V_{IN} = 3.2 \text{ V}$, $I_{OUT} = 0 \text{ mA} \rightarrow 500 \text{ mA}$	—	—	25	mA
Standby consumption current	I_{STB}	$V_{IN} = 14.0 \text{ V}$, $V_{CONT} = 0 \text{ V}$	—	—	3.0	μA
Bias current before starting regulation	I_{RUSH}	$V_{IN} = 2.090 \text{ V}$, $I_{OUT} = 0 \text{ A}$	—	—	5	mA
Control terminal current	I_{CONT}	$V_{IN} = 3.2 \text{ V}$, $I_{OUT} = 250 \text{ mA}$ $V_{CONT} = 1.8 \text{ V}$	—	—	30	μA
Ripple rejection ratio 1	RR1	$V_{IN} = 4.2 \text{ V} \pm 1 \text{ V}$, $f = 120 \text{ Hz}$ $I_{OUT} = 100 \text{ mA}$	57.1	—	—	dB
Minimum input/output voltage difference 1	$V_{DIF(min)1}$	$V_{IN} = 2.3 \text{ V}$, $I_{OUT} = 250 \text{ mA}$	—	0.25	0.45	V
Minimum input/output voltage difference 2	$V_{DIF(min)2}$	$V_{IN} = 2.4 \text{ V}$, $I_{OUT} = 500 \text{ mA}$	—	—	0.8	V
Control terminal threshold high voltage	V_{CONTH}	$V_{IN} = 3.2 \text{ V}$	—	1.45	1.80	V
Control terminal threshold low voltage	V_{CONTL}	$V_{IN} = 3.2 \text{ V}$	0.50	0.70	—	V

• Design reference data

Note) The following values are typical and not guaranteed values.

Parameter	Symbol	Conditions	Min	Typ	Max	Unit
Ripple rejection ratio 2	RR2	$V_{IN} = 4.2 \text{ V} \pm 1 \text{ V}$, $f = 500 \text{ kHz}$ $I_{OUT} = 100 \text{ mA}$	—	30	—	dB
Output noise voltage	V_{NO}	$10 \text{ Hz} \leq f \leq 100 \text{ kHz}$, $I_{OUT} = 100 \text{ mA}$ $V_{IN} = 3.2 \text{ V}$, $CNR = 1 \mu\text{F}$	—	40	—	$\mu\text{V[rms]}$
Output voltage temperature coefficient	$\frac{dV_{OUT}}{dT_a}$	$V_{IN} = 3.2 \text{ V}$, $I_{OUT} = 5 \text{ mA}$ $-30^\circ\text{C} \leq T_a \leq +125^\circ\text{C}$	—	± 40	—	ppm/ $^\circ\text{C}$
Output short-circuit current	I_{OSHORT}	$V_{IN} = 14.0 \text{ V}$, $V_{OUT} = \text{GND}$	—	300	—	mA
Overheat protection operating temperature	T_{JTH}	$V_{IN} = 3.2 \text{ V}$, $I_{OUT} = 5 \text{ mA}$	—	150	—	$^\circ\text{C}$

■ Electrical Characteristics at $T_a = 25^\circ\text{C}$ (continued)

• AN80M25RSP (2.5 V type)

Unless otherwise specially provided, shorten each test time (within 10 ms) so that the test is conducted under the condition that the drift due to the temperature increase in the chip junction part can be neglected. $C_{IN} = 3.3 \mu\text{F}$, $CNR = \text{Open}$, $C_{OUT} = 33 \mu\text{F}$

Parameter	Symbol	Conditions	Min	Typ	Max	Unit
Output voltage	V_{OUT}	$V_{IN} = 3.5 \text{ V}$, $I_{OUT} = 250 \text{ mA}$	2.425	2.5	2.575	V
Line regulation	REG_{IN}	$V_{IN} = 3.5 \text{ V} \rightarrow 14.0 \text{ V}$, $I_{OUT} = 250 \text{ mA}$	—	—	25	mV
Load regulation	REG_{LOA}	$V_{IN} = 3.5 \text{ V}$, $I_{OUT} = 0 \text{ mA} \rightarrow 500 \text{ mA}$	—	—	50	mV
Peak output current	I_{PEAK}	$V_{IN} = 3.5 \text{ V}$, The output current value when V_{OUT} decreases by 5% from its value at $I_{OUT} = 250 \text{ mA}$.	600	900	—	mA
Bias current under no load	I_{BIAS}	$V_{IN} = 3.5 \text{ V}$, $I_{OUT} = 0 \text{ mA}$	—	1.1	3.0	mA
Bias current fluctuation to input	$\Delta I_{BIAS(IN)}$	$V_{IN} = 3.5 \text{ V} \rightarrow 14.0 \text{ V}$, $I_{OUT} = 250 \text{ mA}$	-5	—	5	mA
Bias current fluctuation to load	$\Delta I_{BIAS(LOA)}$	$V_{IN} = 3.5 \text{ V}$, $I_{OUT} = 0 \text{ mA} \rightarrow 500 \text{ mA}$	—	—	25	mA
Standby consumption current	I_{STB}	$V_{IN} = 14.0 \text{ V}$, $V_{CONT} = 0 \text{ V}$	—	—	3.0	μA
Bias current before starting regulation	I_{RUSH}	$V_{IN} = 2.375 \text{ V}$, $I_{OUT} = 0 \text{ A}$	—	—	5	mA
Control terminal current	I_{CONT}	$V_{IN} = 3.5 \text{ V}$, $I_{OUT} = 250 \text{ mA}$ $V_{CONT} = 1.8 \text{ V}$	—	—	30	μA
Ripple rejection ratio 1	RR1	$V_{IN} = 4.5 \text{ V} \pm 1 \text{ V}$, $f = 120 \text{ Hz}$ $I_{OUT} = 100 \text{ mA}$	56.0	—	—	dB
Minimum input/output voltage difference 1	$V_{DIF(min)1}$	$V_{IN} = 2.6 \text{ V}$, $I_{OUT} = 250 \text{ mA}$	—	0.25	0.45	V
Minimum input/output voltage difference 2	$V_{DIF(min)2}$	$V_{IN} = 2.7 \text{ V}$, $I_{OUT} = 500 \text{ mA}$	—	—	0.8	V
Control terminal threshold high voltage	V_{CONTH}	$V_{IN} = 3.5 \text{ V}$	—	1.45	1.80	V
Control terminal threshold low voltage	V_{CONTL}	$V_{IN} = 3.5 \text{ V}$	0.50	0.70	—	V

• Design reference data

Note) The following values are typical and not guaranteed values.

Parameter	Symbol	Conditions	Min	Typ	Max	Unit
Ripple rejection ratio 2	RR2	$V_{IN} = 4.5 \text{ V} \pm 1 \text{ V}$, $f = 500 \text{ kHz}$ $I_{OUT} = 100 \text{ mA}$	—	30	—	dB
Output noise voltage	V_{NO}	$10 \text{ Hz} \leq f \leq 100 \text{ kHz}$, $I_{OUT} = 100 \text{ mA}$ $V_{IN} = 3.5 \text{ V}$, $CNR = 1 \mu\text{F}$	—	40	—	$\mu\text{V[rms]}$
Output voltage temperature coefficient	$\frac{dV_{OUT}}{dT_a}$	$V_{IN} = 3.5 \text{ V}$, $I_{OUT} = 5 \text{ mA}$ $-30^\circ\text{C} \leq T_a \leq +125^\circ\text{C}$	—	± 40	—	ppm/ $^\circ\text{C}$
Output short-circuit current	I_{OSHORT}	$V_{IN} = 14.0 \text{ V}$, $V_{OUT} = \text{GND}$	—	300	—	mA
Overheat protection operating temperature	T_{JTH}	$V_{IN} = 3.5 \text{ V}$, $I_{OUT} = 5 \text{ mA}$	—	150	—	$^\circ\text{C}$

■ Electrical Characteristics at $T_a = 25^\circ\text{C}$ (continued)

• AN80M27RSP (2.7 V type)

Unless otherwise specially provided, shorten each test time (within 10 ms) so that the test is conducted under the condition that the drift due to the temperature increase in the chip junction part can be neglected. $C_{IN} = 3.3 \mu\text{F}$, $CNR = \text{Open}$, $C_{OUT} = 33 \mu\text{F}$

Parameter	Symbol	Conditions	Min	Typ	Max	Unit
Output voltage	V_{OUT}	$V_{IN} = 3.7 \text{ V}$, $I_{OUT} = 250 \text{ mA}$	2.619	2.7	2.781	V
Line regulation	REG_{IN}	$V_{IN} = 3.7 \text{ V} \rightarrow 14.0 \text{ V}$, $I_{OUT} = 250 \text{ mA}$	—	—	27	mV
Load regulation	REG_{LOA}	$V_{IN} = 3.7 \text{ V}$, $I_{OUT} = 0 \text{ mA} \rightarrow 500 \text{ mA}$	—	—	54	mV
Peak output current	I_{PEAK}	$V_{IN} = 3.7 \text{ V}$, The output current value when V_{OUT} decreases by 5% from its value at $I_{OUT} = 250 \text{ mA}$.	600	900	—	mA
Bias current under no load	I_{BIAS}	$V_{IN} = 3.7 \text{ V}$, $I_{OUT} = 0 \text{ mA}$	—	1.1	3.0	mA
Bias current fluctuation to input	$\Delta I_{BIAS(IN)}$	$V_{IN} = 3.7 \text{ V} \rightarrow 14.0 \text{ V}$, $I_{OUT} = 250 \text{ mA}$	-5	—	5	mA
Bias current fluctuation to load	$\Delta I_{BIAS(LOA)}$	$V_{IN} = 3.7 \text{ V}$, $I_{OUT} = 0 \text{ mA} \rightarrow 500 \text{ mA}$	—	—	25	mA
Standby consumption current	I_{STB}	$V_{IN} = 14.0 \text{ V}$, $V_{CONT} = 0 \text{ V}$	—	—	3.0	μA
Bias current before starting regulation	I_{RUSH}	$V_{IN} = 2.565 \text{ V}$, $I_{OUT} = 0 \text{ A}$	—	—	5	mA
Control terminal current	I_{CONT}	$V_{IN} = 3.7 \text{ V}$, $I_{OUT} = 250 \text{ mA}$ $V_{CONT} = 1.8 \text{ V}$	—	—	30	μA
Ripple rejection ratio 1	RR1	$V_{IN} = 4.7 \text{ V} \pm 1 \text{ V}$, $f = 120 \text{ Hz}$ $I_{OUT} = 100 \text{ mA}$	55.3	—	—	dB
Minimum input/output voltage difference 1	$V_{DIF(min)1}$	$V_{IN} = 2.8 \text{ V}$, $I_{OUT} = 250 \text{ mA}$	—	0.25	0.45	V
Minimum input/output voltage difference 2	$V_{DIF(min)2}$	$V_{IN} = 2.9 \text{ V}$, $I_{OUT} = 500 \text{ mA}$	—	—	0.8	V
Control terminal threshold high voltage	V_{CONTH}	$V_{IN} = 3.7 \text{ V}$	—	1.45	1.80	V
Control terminal threshold low voltage	V_{CONTL}	$V_{IN} = 3.7 \text{ V}$	0.50	0.70	—	V

• Design reference data

Note) The following values are typical and not guaranteed values.

Parameter	Symbol	Conditions	Min	Typ	Max	Unit
Ripple rejection ratio 2	RR2	$V_{IN} = 4.7 \text{ V} \pm 1 \text{ V}$, $f = 500 \text{ kHz}$ $I_{OUT} = 100 \text{ mA}$	—	30	—	dB
Output noise voltage	V_{NO}	$10 \text{ Hz} \leq f \leq 100 \text{ kHz}$, $I_{OUT} = 100 \text{ mA}$ $V_{IN} = 3.7 \text{ V}$, $CNR = 1 \mu\text{F}$	—	40	—	$\mu\text{V[rms]}$
Output voltage temperature coefficient	$\frac{dV_{OUT}}{dT_a}$	$V_{IN} = 3.7 \text{ V}$, $I_{OUT} = 5 \text{ mA}$ $-30^\circ\text{C} \leq T_a \leq +125^\circ\text{C}$	—	± 40	—	ppm/ $^\circ\text{C}$
Output short-circuit current	I_{OSHORT}	$V_{IN} = 14.0 \text{ V}$, $V_{OUT} = \text{GND}$	—	300	—	mA
Overheat protection operating temperature	T_{JTH}	$V_{IN} = 3.7 \text{ V}$, $I_{OUT} = 5 \text{ mA}$	—	150	—	$^\circ\text{C}$

■ Electrical Characteristics at $T_a = 25^\circ\text{C}$ (continued)

• AN80M28RSP (2.8 V type)

Unless otherwise specially provided, shorten each test time (within 10 ms) so that the test is conducted under the condition that the drift due to the temperature increase in the chip junction part can be neglected. $C_{IN} = 3.3 \mu\text{F}$, $CNR = \text{Open}$, $C_{OUT} = 33 \mu\text{F}$

Parameter	Symbol	Conditions	Min	Typ	Max	Unit
Output voltage	V_{OUT}	$V_{IN} = 3.8 \text{ V}$, $I_{OUT} = 250 \text{ mA}$	2.716	2.8	2.884	V
Line regulation	REG_{IN}	$V_{IN} = 3.8 \text{ V} \rightarrow 14.0 \text{ V}$, $I_{OUT} = 250 \text{ mA}$	—	—	28	mV
Load regulation	REG_{LOA}	$V_{IN} = 3.8 \text{ V}$, $I_{OUT} = 0 \text{ mA} \rightarrow 500 \text{ mA}$	—	—	56	mV
Peak output current	I_{PEAK}	$V_{IN} = 3.8 \text{ V}$, The output current value when V_{OUT} decreases by 5% from its value at $I_{OUT} = 250 \text{ mA}$.	600	900	—	mA
Bias current under no load	I_{BIAS}	$V_{IN} = 3.8 \text{ V}$, $I_{OUT} = 0 \text{ mA}$	—	1.1	3.0	mA
Bias current fluctuation to input	$\Delta I_{BIAS(IN)}$	$V_{IN} = 3.8 \text{ V} \rightarrow 14.0 \text{ V}$, $I_{OUT} = 250 \text{ mA}$	-5	—	5	mA
Bias current fluctuation to load	$\Delta I_{BIAS(LOA)}$	$V_{IN} = 3.8 \text{ V}$, $I_{OUT} = 0 \text{ mA} \rightarrow 500 \text{ mA}$	—	—	25	mA
Standby consumption current	I_{STB}	$V_{IN} = 14.0 \text{ V}$, $V_{CONT} = 0 \text{ V}$	—	—	3.0	μA
Bias current before starting regulation	I_{RUSH}	$V_{IN} = 2.660 \text{ V}$, $I_{OUT} = 0 \text{ A}$	—	—	5	mA
Control terminal current	I_{CONT}	$V_{IN} = 3.8 \text{ V}$, $I_{OUT} = 250 \text{ mA}$ $V_{CONT} = 1.8 \text{ V}$	—	—	30	μA
Ripple rejection ratio 1	RR1	$V_{IN} = 4.8 \text{ V} \pm 1 \text{ V}$, $f = 120 \text{ Hz}$ $I_{OUT} = 100 \text{ mA}$	55.0	—	—	dB
Minimum input/output voltage difference 1	$V_{DIF(min)1}$	$V_{IN} = 2.9 \text{ V}$, $I_{OUT} = 250 \text{ mA}$	—	0.25	0.45	V
Minimum input/output voltage difference 2	$V_{DIF(min)2}$	$V_{IN} = 3.0 \text{ V}$, $I_{OUT} = 500 \text{ mA}$	—	—	0.8	V
Control terminal threshold high voltage	V_{CONTH}	$V_{IN} = 3.8 \text{ V}$	—	1.45	1.80	V
Control terminal threshold low voltage	V_{CONTL}	$V_{IN} = 3.8 \text{ V}$	0.50	0.70	—	V

• Design reference data

Note) The following values are typical and not guaranteed values.

Parameter	Symbol	Conditions	Min	Typ	Max	Unit
Ripple rejection ratio 2	RR2	$V_{IN} = 4.8 \text{ V} \pm 1 \text{ V}$, $f = 500 \text{ kHz}$ $I_{OUT} = 100 \text{ mA}$	—	30	—	dB
Output noise voltage	V_{NO}	$10 \text{ Hz} \leq f \leq 100 \text{ kHz}$, $I_{OUT} = 100 \text{ mA}$ $V_{IN} = 3.8 \text{ V}$, $CNR = 1 \mu\text{F}$	—	40	—	$\mu\text{V[rms]}$
Output voltage temperature coefficient	$\frac{dV_{OUT}}{dT_a}$	$V_{IN} = 3.8 \text{ V}$, $I_{OUT} = 5 \text{ mA}$ $-30^\circ\text{C} \leq T_a \leq +125^\circ\text{C}$	—	± 40	—	ppm/ $^\circ\text{C}$
Output short-circuit current	I_{OSHORT}	$V_{IN} = 14.0 \text{ V}$, $V_{OUT} = \text{GND}$	—	300	—	mA
Overheat protection operating temperature	T_{JTH}	$V_{IN} = 3.8 \text{ V}$, $I_{OUT} = 5 \text{ mA}$	—	150	—	$^\circ\text{C}$

■ Electrical Characteristics at $T_a = 25^\circ\text{C}$ (continued)

• AN80M29RSP (2.9 V type)

Unless otherwise specially provided, shorten each test time (within 10 ms) so that the test is conducted under the condition that the drift due to the temperature increase in the chip junction part can be neglected. $C_{IN} = 3.3 \mu\text{F}$, $CNR = \text{Open}$, $C_{OUT} = 33 \mu\text{F}$

Parameter	Symbol	Conditions	Min	Typ	Max	Unit
Output voltage	V_{OUT}	$V_{IN} = 3.9 \text{ V}$, $I_{OUT} = 250 \text{ mA}$	2.813	2.9	2.987	V
Line regulation	REG_{IN}	$V_{IN} = 3.9 \text{ V} \rightarrow 14.0 \text{ V}$, $I_{OUT} = 250 \text{ mA}$	—	—	29	mV
Load regulation	REG_{LOA}	$V_{IN} = 3.9 \text{ V}$, $I_{OUT} = 0 \text{ mA} \rightarrow 500 \text{ mA}$	—	—	58	mV
Peak output current	I_{PEAK}	$V_{IN} = 3.9 \text{ V}$, The output current value when V_{OUT} decreases by 5% from its value at $I_{OUT} = 250 \text{ mA}$.	600	900	—	mA
Bias current under no load	I_{BIAS}	$V_{IN} = 3.9 \text{ V}$, $I_{OUT} = 0 \text{ mA}$	—	1.1	3.0	mA
Bias current fluctuation to input	$\Delta I_{BIAS(IN)}$	$V_{IN} = 3.9 \text{ V} \rightarrow 14.0 \text{ V}$, $I_{OUT} = 250 \text{ mA}$	-5	—	5	mA
Bias current fluctuation to load	$\Delta I_{BIAS(LOA)}$	$V_{IN} = 3.9 \text{ V}$, $I_{OUT} = 0 \text{ mA} \rightarrow 500 \text{ mA}$	—	—	25	mA
Standby consumption current	I_{STB}	$V_{IN} = 14.0 \text{ V}$, $V_{CONT} = 0 \text{ V}$	—	—	3.0	μA
Bias current before starting regulation	I_{RUSH}	$V_{IN} = 2.755 \text{ V}$, $I_{OUT} = 0 \text{ A}$	—	—	5	mA
Control terminal current	I_{CONT}	$V_{IN} = 3.9 \text{ V}$, $I_{OUT} = 250 \text{ mA}$ $V_{CONT} = 1.8 \text{ V}$	—	—	30	μA
Ripple rejection ratio 1	RR1	$V_{IN} = 4.9 \text{ V} \pm 1 \text{ V}$, $f = 120 \text{ Hz}$ $I_{OUT} = 100 \text{ mA}$	54.7	—	—	dB
Minimum input/output voltage difference 1	$V_{DIF(min)1}$	$V_{IN} = 3.0 \text{ V}$, $I_{OUT} = 250 \text{ mA}$	—	0.25	0.45	V
Minimum input/output voltage difference 2	$V_{DIF(min)2}$	$V_{IN} = 3.1 \text{ V}$, $I_{OUT} = 500 \text{ mA}$	—	—	0.8	V
Control terminal threshold high voltage	V_{CONTH}	$V_{IN} = 3.9 \text{ V}$	—	1.45	1.80	V
Control terminal threshold low voltage	V_{CONTL}	$V_{IN} = 3.9 \text{ V}$	0.50	0.70	—	V

• Design reference data

Note) The following values are typical and not guaranteed values.

Parameter	Symbol	Conditions	Min	Typ	Max	Unit
Ripple rejection ratio 2	RR2	$V_{IN} = 4.9 \text{ V} \pm 1 \text{ V}$, $f = 500 \text{ kHz}$ $I_{OUT} = 100 \text{ mA}$	—	30	—	dB
Output noise voltage	V_{NO}	$10 \text{ Hz} \leq f \leq 100 \text{ kHz}$, $I_{OUT} = 100 \text{ mA}$ $V_{IN} = 3.9 \text{ V}$, $CNR = 1 \mu\text{F}$	—	40	—	$\mu\text{V[rms]}$
Output voltage temperature coefficient	$\frac{dV_{OUT}}{dT_a}$	$V_{IN} = 3.9 \text{ V}$, $I_{OUT} = 5 \text{ mA}$ $-30^\circ\text{C} \leq T_a \leq +125^\circ\text{C}$	—	± 40	—	ppm/ $^\circ\text{C}$
Output short-circuit current	I_{OSHORT}	$V_{IN} = 14.0 \text{ V}$, $V_{OUT} = \text{GND}$	—	300	—	mA
Overheat protection operating temperature	T_{JTH}	$V_{IN} = 3.9 \text{ V}$, $I_{OUT} = 5 \text{ mA}$	—	150	—	$^\circ\text{C}$

■ Electrical Characteristics at $T_a = 25^\circ\text{C}$ (continued)

• AN80M30RSP (3.0 V type)

Unless otherwise specially provided, shorten each test time (within 10 ms) so that the test is conducted under the condition that the drift due to the temperature increase in the chip junction part can be neglected. $C_{IN} = 3.3 \mu\text{F}$, $C_{NR} = \text{Open}$, $C_{OUT} = 33 \mu\text{F}$

Parameter	Symbol	Conditions	Min	Typ	Max	Unit
Output voltage	V_{OUT}	$V_{IN} = 4.0 \text{ V}$, $I_{OUT} = 250 \text{ mA}$	2.910	3.0	3.090	V
Line regulation	REG_{IN}	$V_{IN} = 4.0 \text{ V} \rightarrow 14.0 \text{ V}$, $I_{OUT} = 250 \text{ mA}$	—	—	30	mV
Load regulation	REG_{LOA}	$V_{IN} = 4.0 \text{ V}$, $I_{OUT} = 0 \text{ mA} \rightarrow 500 \text{ mA}$	—	—	60	mV
Peak output current	I_{PEAK}	$V_{IN} = 4.0 \text{ V}$, The output current value when V_{OUT} decreases by 5% from its value at $I_{OUT} = 250 \text{ mA}$.	600	900	—	mA
Bias current under no load	I_{BIAS}	$V_{IN} = 4.0 \text{ V}$, $I_{OUT} = 0 \text{ mA}$	—	1.1	3.0	mA
Bias current fluctuation to input	$\Delta I_{BIAS(IN)}$	$V_{IN} = 4.0 \text{ V} \rightarrow 14.0 \text{ V}$, $I_{OUT} = 250 \text{ mA}$	-5	—	5	mA
Bias current fluctuation to load	$\Delta I_{BIAS(LOA)}$	$V_{IN} = 4.0 \text{ V}$, $I_{OUT} = 0 \text{ mA} \rightarrow 500 \text{ mA}$	—	—	25	mA
Standby consumption current	I_{STB}	$V_{IN} = 14.0 \text{ V}$, $V_{CONT} = 0 \text{ V}$	—	—	3.0	μA
Bias current before starting regulation	I_{RUSH}	$V_{IN} = 2.85 \text{ V}$, $I_{OUT} = 0 \text{ A}$	—	—	5	mA
Control terminal current	I_{CONT}	$V_{IN} = 4.0 \text{ V}$, $I_{OUT} = 250 \text{ mA}$ $V_{CONT} = 1.8 \text{ V}$	—	—	30	μA
Ripple rejection ratio 1	RR1	$V_{IN} = 5 \text{ V} \pm 1 \text{ V}$, $f = 120 \text{ Hz}$ $I_{OUT} = 100 \text{ mA}$	54.4	—	—	dB
Minimum input/output voltage difference 1	$V_{DIF(min)1}$	$V_{IN} = 3.1 \text{ V}$, $I_{OUT} = 250 \text{ mA}$	—	0.25	0.45	V
Minimum input/output voltage difference 2	$V_{DIF(min)2}$	$V_{IN} = 3.2 \text{ V}$, $I_{OUT} = 500 \text{ mA}$	—	—	0.8	V
Control terminal threshold high voltage	V_{CONTH}	$V_{IN} = 4.0 \text{ V}$	—	1.45	1.80	V
Control terminal threshold low voltage	V_{CONTL}	$V_{IN} = 4.0 \text{ V}$	0.50	0.70	—	V

• Design reference data

Note) The following values are typical and not guaranteed values.

Parameter	Symbol	Conditions	Min	Typ	Max	Unit
Ripple rejection ratio 2	RR2	$V_{IN} = 5 \text{ V} \pm 1 \text{ V}$, $f = 500 \text{ kHz}$ $I_{OUT} = 100 \text{ mA}$	—	30	—	dB
Output noise voltage	V_{NO}	$10 \text{ Hz} \leq f \leq 100 \text{ kHz}$, $I_{OUT} = 100 \text{ mA}$ $V_{IN} = 4 \text{ V}$, $C_{NR} = 1 \mu\text{F}$	—	40	—	$\mu\text{V[rms]}$
Output voltage temperature coefficient	$\frac{dV_{OUT}}{dT_a}$	$V_{IN} = 4 \text{ V}$, $I_{OUT} = 5 \text{ mA}$ $-30^\circ\text{C} \leq T_a \leq +125^\circ\text{C}$	—	± 40	—	ppm/ $^\circ\text{C}$
Output short-circuit current	I_{OSHORT}	$V_{IN} = 14.0 \text{ V}$, $V_{OUT} = \text{GND}$	—	300	—	mA
Overheat protection operating temperature	T_{JTH}	$V_{IN} = 4 \text{ V}$, $I_{OUT} = 5 \text{ mA}$	—	150	—	$^\circ\text{C}$

■ Electrical Characteristics at $T_a = 25^\circ\text{C}$ (continued)

• AN80M31RSP (3.1 V type)

Unless otherwise specially provided, shorten each test time (within 10 ms) so that the test is conducted under the condition that the drift due to the temperature increase in the chip junction part can be neglected. $C_{IN} = 3.3 \mu\text{F}$, $\text{CNR} = \text{Open}$, $C_{OUT} = 33 \mu\text{F}$

Parameter	Symbol	Conditions	Min	Typ	Max	Unit
Output voltage	V_{OUT}	$V_{IN} = 4.1 \text{ V}$, $I_{OUT} = 250 \text{ mA}$	3.007	3.1	3.139	V
Line regulation	REG_{IN}	$V_{IN} = 4.1 \text{ V} \rightarrow 14.0 \text{ V}$, $I_{OUT} = 250 \text{ mA}$	—	—	31	mV
Load regulation	REG_{LOA}	$V_{IN} = 4.1 \text{ V}$, $I_{OUT} = 0 \text{ mA} \rightarrow 500 \text{ mA}$	—	—	62	mV
Peak output current	I_{PEAK}	$V_{IN} = 4.1 \text{ V}$, The output current value when V_{OUT} decreases by 5% from its value at $I_{OUT} = 250 \text{ mA}$.	600	900	—	mA
Bias current under no load	I_{BIAS}	$V_{IN} = 4.1 \text{ V}$, $I_{OUT} = 0 \text{ mA}$	—	1.1	3.0	mA
Bias current fluctuation to input	$\Delta I_{BIAS(IN)}$	$V_{IN} = 4.1 \text{ V} \rightarrow 14.0 \text{ V}$, $I_{OUT} = 250 \text{ mA}$	-5	—	5	mA
Bias current fluctuation to load	$\Delta I_{BIAS(LOA)}$	$V_{IN} = 4.1 \text{ V}$, $I_{OUT} = 0 \text{ mA} \rightarrow 500 \text{ mA}$	—	—	25	mA
Standby consumption current	I_{STB}	$V_{IN} = 14.0 \text{ V}$, $V_{CONT} = 0 \text{ V}$	—	—	3.0	μA
Bias current before starting regulation	I_{RUSH}	$V_{IN} = 2.945 \text{ V}$, $I_{OUT} = 0 \text{ A}$	—	—	5	mA
Control terminal current	I_{CONT}	$V_{IN} = 4.1 \text{ V}$, $I_{OUT} = 250 \text{ mA}$ $V_{CONT} = 1.8 \text{ V}$	—	—	30	μA
Ripple rejection ratio 1	RR1	$V_{IN} = 5 \text{ V} \pm 1 \text{ V}$, $f = 120 \text{ Hz}$ $I_{OUT} = 100 \text{ mA}$	54.1	—	—	dB
Minimum input/output voltage difference 1	$V_{DIF(min)1}$	$V_{IN} = 3.2 \text{ V}$, $I_{OUT} = 250 \text{ mA}$	—	0.25	0.45	V
Minimum input/output voltage difference 2	$V_{DIF(min)2}$	$V_{IN} = 3.3 \text{ V}$, $I_{OUT} = 500 \text{ mA}$	—	—	0.8	V
Control terminal threshold high voltage	V_{CONTH}	$V_{IN} = 4.1 \text{ V}$	—	1.45	1.80	V
Control terminal threshold low voltage	V_{CONTL}	$V_{IN} = 4.1 \text{ V}$	0.50	0.70	—	V

• Design reference data

Note) The following values are typical and not guaranteed values.

Parameter	Symbol	Conditions	Min	Typ	Max	Unit
Ripple rejection ratio 2	RR2	$V_{IN} = 5.1 \text{ V} \pm 1 \text{ V}$, $f = 500 \text{ kHz}$ $I_{OUT} = 100 \text{ mA}$	—	30	—	dB
Output noise voltage	V_{NO}	$10 \text{ Hz} \leq f \leq 100 \text{ kHz}$, $I_{OUT} = 100 \text{ mA}$ $V_{IN} = 4.1 \text{ V}$, $\text{CNR} = 1 \mu\text{F}$	—	40	—	$\mu\text{V}[\text{rms}]$
Output voltage temperature coefficient	$\frac{dV_{OUT}}{dT_a}$	$V_{IN} = 4.1 \text{ V}$, $I_{OUT} = 5 \text{ mA}$ $-30^\circ\text{C} \leq T_a \leq +125^\circ\text{C}$	—	± 40	—	ppm/ $^\circ\text{C}$
Output short-circuit current	I_{OSHORT}	$V_{IN} = 14.0 \text{ V}$, $V_{OUT} = \text{GND}$	—	300	—	mA
Overheat protection operating temperature	T_{JTH}	$V_{IN} = 4.1 \text{ V}$, $I_{OUT} = 5 \text{ mA}$	—	150	—	$^\circ\text{C}$

■ Electrical Characteristics at $T_a = 25^\circ\text{C}$ (continued)

• AN80M32RSP (3.2 V type)

Unless otherwise specially provided, shorten each test time (within 10 ms) so that the test is conducted under the condition that the drift due to the temperature increase in the chip junction part can be neglected. $C_{IN} = 3.3 \mu\text{F}$, $CNR = \text{Open}$, $C_{OUT} = 33 \mu\text{F}$

Parameter	Symbol	Conditions	Min	Typ	Max	Unit
Output voltage	V_{OUT}	$V_{IN} = 4.2 \text{ V}$, $I_{OUT} = 250 \text{ mA}$	3.104	3.2	3.296	V
Line regulation	REG_{IN}	$V_{IN} = 4.2 \text{ V} \rightarrow 14.0 \text{ V}$, $I_{OUT} = 250 \text{ mA}$	—	—	32	mV
Load regulation	REG_{LOA}	$V_{IN} = 4.2 \text{ V}$, $I_{OUT} = 0 \text{ mA} \rightarrow 500 \text{ mA}$	—	—	64	mV
Peak output current	I_{PEAK}	$V_{IN} = 4.2 \text{ V}$, The output current value when V_{OUT} decreases by 5% from its value at $I_{OUT} = 250 \text{ mA}$.	600	900	—	mA
Bias current under no load	I_{BIAS}	$V_{IN} = 4.2 \text{ V}$, $I_{OUT} = 0 \text{ mA}$	—	1.1	3.0	mA
Bias current fluctuation to input	$\Delta I_{BIAS(IN)}$	$V_{IN} = 4.2 \text{ V} \rightarrow 14.0 \text{ V}$, $I_{OUT} = 250 \text{ mA}$	-5	—	5	mA
Bias current fluctuation to load	$\Delta I_{BIAS(LOA)}$	$V_{IN} = 4.2 \text{ V}$, $I_{OUT} = 0 \text{ mA} \rightarrow 500 \text{ mA}$	—	—	25	mA
Standby consumption current	I_{STB}	$V_{IN} = 14.0 \text{ V}$, $V_{CONT} = 0 \text{ V}$	—	—	3.0	μA
Bias current before starting regulation	I_{RUSH}	$V_{IN} = 3.040 \text{ V}$, $I_{OUT} = 0 \text{ A}$	—	—	5	mA
Control terminal current	I_{CONT}	$V_{IN} = 4.2 \text{ V}$, $I_{OUT} = 250 \text{ mA}$ $V_{CONT} = 1.8 \text{ V}$	—	—	30	μA
Ripple rejection ratio 1	RR1	$V_{IN} = 5.2 \text{ V} \pm 1 \text{ V}$, $f = 120 \text{ Hz}$ $I_{OUT} = 100 \text{ mA}$	53.8	—	—	dB
Minimum input/output voltage difference 1	$V_{DIF(min)1}$	$V_{IN} = 3.3 \text{ V}$, $I_{OUT} = 250 \text{ mA}$	—	0.25	0.45	V
Minimum input/output voltage difference 2	$V_{DIF(min)2}$	$V_{IN} = 3.4 \text{ V}$, $I_{OUT} = 500 \text{ mA}$	—	—	0.8	V
Control terminal threshold high voltage	V_{CONTH}	$V_{IN} = 4.2 \text{ V}$	—	1.45	1.80	V
Control terminal threshold low voltage	V_{CONTL}	$V_{IN} = 4.2 \text{ V}$	0.50	0.70	—	V

• Design reference data

Note) The following values are typical and not guaranteed values.

Parameter	Symbol	Conditions	Min	Typ	Max	Unit
Ripple rejection ratio 2	RR2	$V_{IN} = 5.2 \text{ V} \pm 1 \text{ V}$, $f = 500 \text{ kHz}$ $I_{OUT} = 100 \text{ mA}$	—	30	—	dB
Output noise voltage	V_{NO}	$10 \text{ Hz} \leq f \leq 100 \text{ kHz}$, $I_{OUT} = 100 \text{ mA}$ $V_{IN} = 4.2 \text{ V}$, $CNR = 1 \mu\text{F}$	—	40	—	$\mu\text{V[rms]}$
Output voltage temperature coefficient	$\frac{dV_{OUT}}{dT_a}$	$V_{IN} = 4.2 \text{ V}$, $I_{OUT} = 5 \text{ mA}$ $-30^\circ\text{C} \leq T_a \leq +125^\circ\text{C}$	—	± 40	—	ppm/ $^\circ\text{C}$
Output short-circuit current	I_{OSHORT}	$V_{IN} = 14.0 \text{ V}$, $V_{OUT} = \text{GND}$	—	300	—	mA
Overheat protection operating temperature	T_{JTH}	$V_{IN} = 4.2 \text{ V}$, $I_{OUT} = 5 \text{ mA}$	—	150	—	$^\circ\text{C}$

■ Electrical Characteristics at $T_a = 25^\circ\text{C}$ (continued)

• AN80M33RSP (3.3 V type)

Unless otherwise specially provided, shorten each test time (within 10 ms) so that the test is conducted under the condition that the drift due to the temperature increase in the chip junction part can be neglected. $C_{IN} = 3.3 \mu\text{F}$, $CNR = \text{Open}$, $C_{OUT} = 33 \mu\text{F}$

Parameter	Symbol	Conditions	Min	Typ	Max	Unit
Output voltage	V_{OUT}	$V_{IN} = 4.3 \text{ V}$, $I_{OUT} = 250 \text{ mA}$	3.201	3.3	3.399	V
Line regulation	REG_{IN}	$V_{IN} = 4.3 \text{ V} \rightarrow 14.0 \text{ V}$, $I_{OUT} = 250 \text{ mA}$	—	—	33	mV
Load regulation	REG_{LOA}	$V_{IN} = 4.3 \text{ V}$, $I_{OUT} = 0 \text{ mA} \rightarrow 500 \text{ mA}$	—	—	66	mV
Peak output current	I_{PEAK}	$V_{IN} = 4.3 \text{ V}$, The output current value when V_{OUT} decreases by 5% from its value at $I_{OUT} = 250 \text{ mA}$.	600	900	—	mA
Bias current under no load	I_{BIAS}	$V_{IN} = 4.3 \text{ V}$, $I_{OUT} = 0 \text{ mA}$	—	1.1	3.0	mA
Bias current fluctuation to input	$\Delta I_{BIAS(IN)}$	$V_{IN} = 4.3 \text{ V} \rightarrow 14.0 \text{ V}$, $I_{OUT} = 250 \text{ mA}$	-5	—	5	mA
Bias current fluctuation to load	$\Delta I_{BIAS(LOA)}$	$V_{IN} = 4.3 \text{ V}$, $I_{OUT} = 0 \text{ mA} \rightarrow 500 \text{ mA}$	—	—	25	mA
Standby consumption current	I_{STB}	$V_{IN} = 14.0 \text{ V}$, $V_{CONT} = 0 \text{ V}$	—	—	3.0	μA
Bias current before starting regulation	I_{RUSH}	$V_{IN} = 3.135 \text{ V}$, $I_{OUT} = 0 \text{ A}$	—	—	5	mA
Control terminal current	I_{CONT}	$V_{IN} = 4.3 \text{ V}$, $I_{OUT} = 250 \text{ mA}$ $V_{CONT} = 1.8 \text{ V}$	—	—	30	μA
Ripple rejection ratio 1	RR1	$V_{IN} = 5.3 \text{ V} \pm 1 \text{ V}$, $f = 120 \text{ Hz}$ $I_{OUT} = 100 \text{ mA}$	53.6	—	—	dB
Minimum input/output voltage difference 1	$V_{DIF(min)1}$	$V_{IN} = 3.4 \text{ V}$, $I_{OUT} = 250 \text{ mA}$	—	0.25	0.45	V
Minimum input/output voltage difference 2	$V_{DIF(min)2}$	$V_{IN} = 3.5 \text{ V}$, $I_{OUT} = 500 \text{ mA}$	—	—	0.8	V
Control terminal threshold high voltage	V_{CONTH}	$V_{IN} = 4.3 \text{ V}$	—	1.45	1.80	V
Control terminal threshold low voltage	V_{CONTL}	$V_{IN} = 4.3 \text{ V}$	0.50	0.70	—	V

• Design reference data

Note) The following values are typical and not guaranteed values.

Parameter	Symbol	Conditions	Min	Typ	Max	Unit
Ripple rejection ratio 2	RR2	$V_{IN} = 5.3 \text{ V} \pm 1 \text{ V}$, $f = 500 \text{ kHz}$ $I_{OUT} = 100 \text{ mA}$	—	30	—	dB
Output noise voltage	V_{NO}	$10 \text{ Hz} \leq f \leq 100 \text{ kHz}$, $I_{OUT} = 100 \text{ mA}$ $V_{IN} = 4.3 \text{ V}$, $CNR = 1 \mu\text{F}$	—	40	—	$\mu\text{V[rms]}$
Output voltage temperature coefficient	$\frac{dV_{OUT}}{dT_a}$	$V_{IN} = 4.3 \text{ V}$, $I_{OUT} = 5 \text{ mA}$ $-30^\circ\text{C} \leq T_a \leq +125^\circ\text{C}$	—	± 40	—	ppm/ $^\circ\text{C}$
Output short-circuit current	I_{OSHORT}	$V_{IN} = 14.0 \text{ V}$, $V_{OUT} = \text{GND}$	—	300	—	mA
Overheat protection operating temperature	T_{JTH}	$V_{IN} = 4.3 \text{ V}$, $I_{OUT} = 5 \text{ mA}$	—	150	—	$^\circ\text{C}$

■ Electrical Characteristics at $T_a = 25^\circ\text{C}$ (continued)

• AN80M34RSP (3.4 V type)

Unless otherwise specially provided, shorten each test time (within 10 ms) so that the test is conducted under the condition that the drift due to the temperature increase in the chip junction part can be neglected. $C_{IN} = 3.3 \mu\text{F}$, $CNR = \text{Open}$, $C_{OUT} = 33 \mu\text{F}$

Parameter	Symbol	Conditions	Min	Typ	Max	Unit
Output voltage	V_{OUT}	$V_{IN} = 4.4 \text{ V}$, $I_{OUT} = 250 \text{ mA}$	3.298	3.4	3.502	V
Line regulation	REG_{IN}	$V_{IN} = 4.4 \text{ V} \rightarrow 14.0 \text{ V}$, $I_{OUT} = 250 \text{ mA}$	—	—	34	mV
Load regulation	REG_{LOA}	$V_{IN} = 4.4 \text{ V}$, $I_{OUT} = 0 \text{ mA} \rightarrow 500 \text{ mA}$	—	—	68	mV
Peak output current	I_{PEAK}	$V_{IN} = 4.4 \text{ V}$, The output current value when V_{OUT} decreases by 5% from its value at $I_{OUT} = 250 \text{ mA}$.	600	900	—	mA
Bias current under no load	I_{BIAS}	$V_{IN} = 4.4 \text{ V}$, $I_{OUT} = 0 \text{ mA}$	—	1.1	3.0	mA
Bias current fluctuation to input	$\Delta I_{BIAS(IN)}$	$V_{IN} = 4.4 \text{ V} \rightarrow 14.0 \text{ V}$, $I_{OUT} = 250 \text{ mA}$	-5	—	5	mA
Bias current fluctuation to load	$\Delta I_{BIAS(LOA)}$	$V_{IN} = 4.4 \text{ V}$, $I_{OUT} = 0 \text{ mA} \rightarrow 500 \text{ mA}$	—	—	25	mA
Standby consumption current	I_{STB}	$V_{IN} = 14.0 \text{ V}$, $V_{CONT} = 0 \text{ V}$	—	—	3.0	μA
Bias current before starting regulation	I_{RUSH}	$V_{IN} = 3.230 \text{ V}$, $I_{OUT} = 0 \text{ A}$	—	—	5	mA
Control terminal current	I_{CONT}	$V_{IN} = 4.4 \text{ V}$, $I_{OUT} = 250 \text{ mA}$ $V_{CONT} = 1.8 \text{ V}$	—	—	30	μA
Ripple rejection ratio 1	RR1	$V_{IN} = 5.4 \text{ V} \pm 1 \text{ V}$, $f = 120 \text{ Hz}$ $I_{OUT} = 100 \text{ mA}$	53.3	—	—	dB
Minimum input/output voltage difference 1	$V_{DIF(min)1}$	$V_{IN} = 3.5 \text{ V}$, $I_{OUT} = 250 \text{ mA}$	—	0.25	0.45	V
Minimum input/output voltage difference 2	$V_{DIF(min)2}$	$V_{IN} = 3.6 \text{ V}$, $I_{OUT} = 500 \text{ mA}$	—	—	0.8	V
Control terminal threshold high voltage	V_{CONTH}	$V_{IN} = 4.4 \text{ V}$	—	1.45	1.80	V
Control terminal threshold low voltage	V_{CONTL}	$V_{IN} = 4.4 \text{ V}$	0.50	0.70	—	V

• Design reference data

Note) The following values are typical and not guaranteed values.

Parameter	Symbol	Conditions	Min	Typ	Max	Unit
Ripple rejection ratio 2	RR2	$V_{IN} = 5.4 \text{ V} \pm 1 \text{ V}$, $f = 500 \text{ kHz}$ $I_{OUT} = 100 \text{ mA}$	—	30	—	dB
Output noise voltage	V_{NO}	$10 \text{ Hz} \leq f \leq 100 \text{ kHz}$, $I_{OUT} = 100 \text{ mA}$ $V_{IN} = 4.4 \text{ V}$, $CNR = 1 \mu\text{F}$	—	40	—	$\mu\text{V[rms]}$
Output voltage temperature coefficient	$\frac{dV_{OUT}}{dT_a}$	$V_{IN} = 4.4 \text{ V}$, $I_{OUT} = 5 \text{ mA}$ $-30^\circ\text{C} \leq T_a \leq +125^\circ\text{C}$	—	± 40	—	ppm/ $^\circ\text{C}$
Output short-circuit current	I_{OSHORT}	$V_{IN} = 14.0 \text{ V}$, $V_{OUT} = \text{GND}$	—	300	—	mA
Overheat protection operating temperature	T_{JTH}	$V_{IN} = 4.4 \text{ V}$, $I_{OUT} = 5 \text{ mA}$	—	150	—	$^\circ\text{C}$

■ Electrical Characteristics at $T_a = 25^\circ\text{C}$ (continued)

• AN80M35RSP (3.5 V type)

Unless otherwise specially provided, shorten each test time (within 10 ms) so that the test is conducted under the condition that the drift due to the temperature increase in the chip junction part can be neglected. $C_{IN} = 3.3 \mu\text{F}$, $CNR = \text{Open}$, $C_{OUT} = 33 \mu\text{F}$

Parameter	Symbol	Conditions	Min	Typ	Max	Unit
Output voltage	V_{OUT}	$V_{IN} = 4.5 \text{ V}$, $I_{OUT} = 250 \text{ mA}$	3.395	3.5	3.605	V
Line regulation	REG_{IN}	$V_{IN} = 4.5 \text{ V} \rightarrow 14.0 \text{ V}$, $I_{OUT} = 250 \text{ mA}$	—	—	35	mV
Load regulation	REG_{LOA}	$V_{IN} = 4.5 \text{ V}$, $I_{OUT} = 0 \text{ mA} \rightarrow 500 \text{ mA}$	—	—	70	mV
Peak output current	I_{PEAK}	$V_{IN} = 4.5 \text{ V}$, The output current value when V_{OUT} decreases by 5% from its value at $I_{OUT} = 250 \text{ mA}$.	600	900	—	mA
Bias current under no load	I_{BIAS}	$V_{IN} = 4.5 \text{ V}$, $I_{OUT} = 0 \text{ mA}$	—	1.1	3.0	mA
Bias current fluctuation to input	$\Delta I_{BIAS(IN)}$	$V_{IN} = 4.5 \text{ V} \rightarrow 14.0 \text{ V}$, $I_{OUT} = 250 \text{ mA}$	-5	—	5	mA
Bias current fluctuation to load	$\Delta I_{BIAS(LOA)}$	$V_{IN} = 4.5 \text{ V}$, $I_{OUT} = 0 \text{ mA} \rightarrow 500 \text{ mA}$	—	—	25	mA
Standby consumption current	I_{STB}	$V_{IN} = 14.0 \text{ V}$, $V_{CONT} = 0 \text{ V}$	—	—	3.0	μA
Bias current before starting regulation	I_{RUSH}	$V_{IN} = 3.325 \text{ V}$, $I_{OUT} = 0 \text{ A}$	—	—	5	mA
Control terminal current	I_{CONT}	$V_{IN} = 4.5 \text{ V}$, $I_{OUT} = 250 \text{ mA}$ $V_{CONT} = 1.8 \text{ V}$	—	—	30	μA
Ripple rejection ratio 1	RR1	$V_{IN} = 5.5 \text{ V} \pm 1 \text{ V}$, $f = 120 \text{ Hz}$ $I_{OUT} = 100 \text{ mA}$	53.1	—	—	dB
Minimum input/output voltage difference 1	$V_{DIF(min)1}$	$V_{IN} = 3.6 \text{ V}$, $I_{OUT} = 250 \text{ mA}$	—	0.25	0.45	V
Minimum input/output voltage difference 2	$V_{DIF(min)2}$	$V_{IN} = 3.7 \text{ V}$, $I_{OUT} = 500 \text{ mA}$	—	—	0.8	V
Control terminal threshold high voltage	V_{CONTH}	$V_{IN} = 4.5 \text{ V}$	—	1.45	1.80	V
Control terminal threshold low voltage	V_{CONTL}	$V_{IN} = 4.5 \text{ V}$	0.50	0.70	—	V

• Design reference data

Note) The following values are typical and not guaranteed values.

Parameter	Symbol	Conditions	Min	Typ	Max	Unit
Ripple rejection ratio 2	RR2	$V_{IN} = 5.5 \text{ V} \pm 1 \text{ V}$, $f = 500 \text{ kHz}$ $I_{OUT} = 100 \text{ mA}$	—	30	—	dB
Output noise voltage	V_{NO}	$10 \text{ Hz} \leq f \leq 100 \text{ kHz}$, $I_{OUT} = 100 \text{ mA}$ $V_{IN} = 4.5 \text{ V}$, $CNR = 1 \mu\text{F}$	—	40	—	$\mu\text{V[rms]}$
Output voltage temperature coefficient	$\frac{dV_{OUT}}{dT_a}$	$V_{IN} = 4.5 \text{ V}$, $I_{OUT} = 5 \text{ mA}$ $-30^\circ\text{C} \leq T_a \leq +125^\circ\text{C}$	—	± 40	—	ppm/ $^\circ\text{C}$
Output short-circuit current	I_{OSHORT}	$V_{IN} = 14.0 \text{ V}$, $V_{OUT} = \text{GND}$	—	300	—	mA
Overheat protection operating temperature	T_{JTH}	$V_{IN} = 4.5 \text{ V}$, $I_{OUT} = 5 \text{ mA}$	—	150	—	$^\circ\text{C}$

■ Electrical Characteristics at $T_a = 25^\circ\text{C}$ (continued)

• AN80M36RSP (3.6 V type)

Unless otherwise specially provided, shorten each test time (within 10 ms) so that the test is conducted under the condition that the drift due to the temperature increase in the chip junction part can be neglected. $C_{IN} = 3.3 \mu\text{F}$, $CNR = \text{Open}$, $C_{OUT} = 33 \mu\text{F}$

Parameter	Symbol	Conditions	Min	Typ	Max	Unit
Output voltage	V_{OUT}	$V_{IN} = 4.6 \text{ V}$, $I_{OUT} = 250 \text{ mA}$	3.492	3.6	3.708	V
Line regulation	REG_{IN}	$V_{IN} = 4.6 \text{ V} \rightarrow 14.0 \text{ V}$, $I_{OUT} = 250 \text{ mA}$	—	—	36	mV
Load regulation	REG_{LOA}	$V_{IN} = 4.6 \text{ V}$, $I_{OUT} = 0 \text{ mA} \rightarrow 500 \text{ mA}$	—	—	72	mV
Peak output current	I_{PEAK}	$V_{IN} = 4.6 \text{ V}$, The output current value when V_{OUT} decreases by 5% from its value at $I_{OUT} = 250 \text{ mA}$.	600	900	—	mA
Bias current under no load	I_{BIAS}	$V_{IN} = 4.6 \text{ V}$, $I_{OUT} = 0 \text{ mA}$	—	1.1	3.0	mA
Bias current fluctuation to input	$\Delta I_{BIAS(IN)}$	$V_{IN} = 4.6 \text{ V} \rightarrow 14.0 \text{ V}$, $I_{OUT} = 250 \text{ mA}$	-5	—	5	mA
Bias current fluctuation to load	$\Delta I_{BIAS(LOA)}$	$V_{IN} = 4.6 \text{ V}$, $I_{OUT} = 0 \text{ mA} \rightarrow 500 \text{ mA}$	—	—	25	mA
Standby consumption current	I_{STB}	$V_{IN} = 14.0 \text{ V}$, $V_{CONT} = 0 \text{ V}$	—	—	3.0	μA
Bias current before starting regulation	I_{RUSH}	$V_{IN} = 3.420 \text{ V}$, $I_{OUT} = 0 \text{ A}$	—	—	5	mA
Control terminal current	I_{CONT}	$V_{IN} = 4.6 \text{ V}$, $I_{OUT} = 250 \text{ mA}$ $V_{CONT} = 1.8 \text{ V}$	—	—	30	μA
Ripple rejection ratio 1	RR1	$V_{IN} = 5.6 \text{ V} \pm 1 \text{ V}$, $f = 120 \text{ Hz}$ $I_{OUT} = 100 \text{ mA}$	52.8	—	—	dB
Minimum input/output voltage difference 1	$V_{DIF(min)1}$	$V_{IN} = 3.7 \text{ V}$, $I_{OUT} = 250 \text{ mA}$	—	0.25	0.45	V
Minimum input/output voltage difference 2	$V_{DIF(min)2}$	$V_{IN} = 3.8 \text{ V}$, $I_{OUT} = 500 \text{ mA}$	—	—	0.8	V
Control terminal threshold high voltage	V_{CONTH}	$V_{IN} = 4.6 \text{ V}$	—	1.45	1.80	V
Control terminal threshold low voltage	V_{CONTL}	$V_{IN} = 4.6 \text{ V}$	0.50	0.70	—	V

• Design reference data

Note) The following values are typical and not guaranteed values.

Parameter	Symbol	Conditions	Min	Typ	Max	Unit
Ripple rejection ratio 2	RR2	$V_{IN} = 5.6 \text{ V} \pm 1 \text{ V}$, $f = 500 \text{ kHz}$ $I_{OUT} = 100 \text{ mA}$	—	30	—	dB
Output noise voltage	V_{NO}	$10 \text{ Hz} \leq f \leq 100 \text{ kHz}$, $I_{OUT} = 100 \text{ mA}$ $V_{IN} = 4.6 \text{ V}$, $CNR = 1 \mu\text{F}$	—	40	—	$\mu\text{V[rms]}$
Output voltage temperature coefficient	$\frac{dV_{OUT}}{dT_a}$	$V_{IN} = 4.6 \text{ V}$, $I_{OUT} = 5 \text{ mA}$ $-30^\circ\text{C} \leq T_a \leq +125^\circ\text{C}$	—	± 40	—	ppm/ $^\circ\text{C}$
Output short-circuit current	I_{OSHORT}	$V_{IN} = 14.0 \text{ V}$, $V_{OUT} = \text{GND}$	—	300	—	mA
Overheat protection operating temperature	T_{JTH}	$V_{IN} = 4.6 \text{ V}$, $I_{OUT} = 5 \text{ mA}$	—	150	—	$^\circ\text{C}$

■ Electrical Characteristics at $T_a = 25^\circ\text{C}$ (continued)

• AN80M48RSP (4.8 V type)

Unless otherwise specially provided, shorten each test time (within 10 ms) so that the test is conducted under the condition that the drift due to the temperature increase in the chip junction part can be neglected. $C_{IN} = 3.3 \mu\text{F}$, $CNR = \text{Open}$, $C_{OUT} = 33 \mu\text{F}$

Parameter	Symbol	Conditions	Min	Typ	Max	Unit
Output voltage	V_{OUT}	$V_{IN} = 5.8 \text{ V}$, $I_{OUT} = 250 \text{ mA}$	4.656	4.8	4.944	V
Line regulation	REG_{IN}	$V_{IN} = 5.8 \text{ V} \rightarrow 14.0 \text{ V}$, $I_{OUT} = 250 \text{ mA}$	—	—	48	mV
Load regulation	REG_{LOA}	$V_{IN} = 5.8 \text{ V}$, $I_{OUT} = 0 \text{ mA} \rightarrow 500 \text{ mA}$	—	—	96	mV
Peak output current	I_{PEAK}	$V_{IN} = 5.8 \text{ V}$, The output current value when V_{OUT} decreases by 5% from its value at $I_{OUT} = 250 \text{ mA}$.	600	900	—	mA
Bias current under no load	I_{BIAS}	$V_{IN} = 5.8 \text{ V}$, $I_{OUT} = 0 \text{ mA}$	—	1.1	3.0	mA
Bias current fluctuation to input	$\Delta I_{BIAS(IN)}$	$V_{IN} = 5.8 \text{ V} \rightarrow 14.0 \text{ V}$, $I_{OUT} = 250 \text{ mA}$	-5	—	5	mA
Bias current fluctuation to load	$\Delta I_{BIAS(LOA)}$	$V_{IN} = 5.8 \text{ V}$, $I_{OUT} = 0 \text{ mA} \rightarrow 500 \text{ mA}$	—	—	25	mA
Standby consumption current	I_{STB}	$V_{IN} = 14.0 \text{ V}$, $V_{CONT} = 0 \text{ V}$	—	—	3.0	μA
Bias current before starting regulation	I_{RUSH}	$V_{IN} = 4.560 \text{ V}$, $I_{OUT} = 0 \text{ A}$	—	—	5	mA
Control terminal current	I_{CONT}	$V_{IN} = 5.8 \text{ V}$, $I_{OUT} = 250 \text{ mA}$ $V_{CONT} = 1.8 \text{ V}$	—	—	30	μA
Ripple rejection ratio 1	RR1	$V_{IN} = 6.8 \text{ V} \pm 1 \text{ V}$, $f = 120 \text{ Hz}$ $I_{OUT} = 100 \text{ mA}$	50.3	—	—	dB
Minimum input/output voltage difference 1	$V_{DIF(min)1}$	$V_{IN} = 4.9 \text{ V}$, $I_{OUT} = 250 \text{ mA}$	—	0.25	0.45	V
Minimum input/output voltage difference 2	$V_{DIF(min)2}$	$V_{IN} = 5.0 \text{ V}$, $I_{OUT} = 500 \text{ mA}$	—	—	0.8	V
Control terminal threshold high voltage	V_{CONTH}	$V_{IN} = 5.8 \text{ V}$	—	1.45	1.80	V
Control terminal threshold low voltage	V_{CONTL}	$V_{IN} = 5.8 \text{ V}$	0.50	0.70	—	V

• Design reference data

Note) The following values are typical and not guaranteed values.

Parameter	Symbol	Conditions	Min	Typ	Max	Unit
Ripple rejection ratio 2	RR2	$V_{IN} = 6.8 \text{ V} \pm 1 \text{ V}$, $f = 500 \text{ kHz}$ $I_{OUT} = 100 \text{ mA}$	—	30	—	dB
Output noise voltage	V_{NO}	$10 \text{ Hz} \leq f \leq 100 \text{ kHz}$, $I_{OUT} = 100 \text{ mA}$ $V_{IN} = 5.8 \text{ V}$, $CNR = 1 \mu\text{F}$	—	40	—	$\mu\text{V[rms]}$
Output voltage temperature coefficient	$\frac{dV_{OUT}}{dT_a}$	$V_{IN} = 5.8 \text{ V}$, $I_{OUT} = 5 \text{ mA}$ $-30^\circ\text{C} \leq T_a \leq +125^\circ\text{C}$	—	± 40	—	ppm/ $^\circ\text{C}$
Output short-circuit current	I_{OSHORT}	$V_{IN} = 14.0 \text{ V}$, $V_{OUT} = \text{GND}$	—	300	—	mA
Overheat protection operating temperature	T_{JTH}	$V_{IN} = 5.8 \text{ V}$, $I_{OUT} = 5 \text{ mA}$	—	150	—	$^\circ\text{C}$

■ Electrical Characteristics at $T_a = 25^\circ\text{C}$ (continued)

• AN80M49RSP (4.9 V type)

Unless otherwise specially provided, shorten each test time (within 10 ms) so that the test is conducted under the condition that the drift due to the temperature increase in the chip junction part can be neglected. $C_{IN} = 3.3 \mu\text{F}$, $CNR = \text{Open}$, $C_{OUT} = 33 \mu\text{F}$

Parameter	Symbol	Conditions	Min	Typ	Max	Unit
Output voltage	V_{OUT}	$V_{IN} = 5.9 \text{ V}$, $I_{OUT} = 250 \text{ mA}$	4.753	4.9	5.047	V
Line regulation	REG_{IN}	$V_{IN} = 5.9 \text{ V} \rightarrow 14.0 \text{ V}$, $I_{OUT} = 250 \text{ mA}$	—	—	49	mV
Load regulation	REG_{LOA}	$V_{IN} = 5.9 \text{ V}$, $I_{OUT} = 0 \text{ mA} \rightarrow 500 \text{ mA}$	—	—	98	mV
Peak output current	I_{PEAK}	$V_{IN} = 5.9 \text{ V}$, The output current value when V_{OUT} decreases by 5% from its value at $I_{OUT} = 250 \text{ mA}$.	600	900	—	mA
Bias current under no load	I_{BIAS}	$V_{IN} = 5.9 \text{ V}$, $I_{OUT} = 0 \text{ mA}$	—	1.1	3.0	mA
Bias current fluctuation to input	$\Delta I_{BIAS(IN)}$	$V_{IN} = 5.9 \text{ V} \rightarrow 14.0 \text{ V}$, $I_{OUT} = 250 \text{ mA}$	-5	—	5	mA
Bias current fluctuation to load	$\Delta I_{BIAS(LOA)}$	$V_{IN} = 5.9 \text{ V}$, $I_{OUT} = 0 \text{ mA} \rightarrow 500 \text{ mA}$	—	—	25	mA
Standby consumption current	I_{STB}	$V_{IN} = 14.0 \text{ V}$, $V_{CONT} = 0 \text{ V}$	—	—	3.0	μA
Bias current before starting regulation	I_{RUSH}	$V_{IN} = 4.655 \text{ V}$, $I_{OUT} = 0 \text{ A}$	—	—	5	mA
Control terminal current	I_{CONT}	$V_{IN} = 5.9 \text{ V}$, $I_{OUT} = 250 \text{ mA}$ $V_{CONT} = 1.8 \text{ V}$	—	—	30	μA
Ripple rejection ratio 1	RR1	$V_{IN} = 6.9 \text{ V} \pm 1 \text{ V}$, $f = 120 \text{ Hz}$ $I_{OUT} = 100 \text{ mA}$	50.1	—	—	dB
Minimum input/output voltage difference 1	$V_{DIF(min)1}$	$V_{IN} = 5.0 \text{ V}$, $I_{OUT} = 250 \text{ mA}$	—	0.25	0.45	V
Minimum input/output voltage difference 2	$V_{DIF(min)2}$	$V_{IN} = 5.1 \text{ V}$, $I_{OUT} = 500 \text{ mA}$	—	—	0.8	V
Control terminal threshold high voltage	V_{CONTH}	$V_{IN} = 5.9 \text{ V}$	—	1.45	1.80	V
Control terminal threshold low voltage	V_{CONTL}	$V_{IN} = 5.9 \text{ V}$	0.50	0.70	—	V

• Design reference data

Note) The following values are typical and not guaranteed values.

Parameter	Symbol	Conditions	Min	Typ	Max	Unit
Ripple rejection ratio 2	RR2	$V_{IN} = 6.9 \text{ V} \pm 1 \text{ V}$, $f = 500 \text{ kHz}$ $I_{OUT} = 100 \text{ mA}$	—	30	—	dB
Output noise voltage	V_{NO}	$10 \text{ Hz} \leq f \leq 100 \text{ kHz}$, $I_{OUT} = 100 \text{ mA}$ $V_{IN} = 5.9 \text{ V}$, $CNR = 1 \mu\text{F}$	—	40	—	$\mu\text{V[rms]}$
Output voltage temperature coefficient	$\frac{dV_{OUT}}{dT_a}$	$V_{IN} = 5.9 \text{ V}$, $I_{OUT} = 5 \text{ mA}$ $-30^\circ\text{C} \leq T_a \leq +125^\circ\text{C}$	—	± 40	—	ppm/ $^\circ\text{C}$
Output short-circuit current	I_{OSHORT}	$V_{IN} = 14.0 \text{ V}$, $V_{OUT} = \text{GND}$	—	300	—	mA
Overheat protection operating temperature	T_{JTH}	$V_{IN} = 5.9 \text{ V}$, $I_{OUT} = 5 \text{ mA}$	—	150	—	$^\circ\text{C}$

■ Electrical Characteristics at $T_a = 25^\circ\text{C}$ (continued)

• AN80M50RSP (5.0 V type)

Unless otherwise specially provided, shorten each test time (within 10 ms) so that the test is conducted under the condition that the drift due to the temperature increase in the chip junction part can be neglected. $C_{IN} = 3.3 \mu\text{F}$, $CNR = \text{Open}$, $C_{OUT} = 33 \mu\text{F}$

Parameter	Symbol	Conditions	Min	Typ	Max	Unit
Output voltage	V_{OUT}	$V_{IN} = 6.0 \text{ V}$, $I_{OUT} = 250 \text{ mA}$	4.850	5.0	5.150	V
Line regulation	REG_{IN}	$V_{IN} = 6.0 \text{ V} \rightarrow 14.0 \text{ V}$, $I_{OUT} = 250 \text{ mA}$	—	—	50	mV
Load regulation	REG_{LOA}	$V_{IN} = 6.0 \text{ V}$, $I_{OUT} = 0 \text{ mA} \rightarrow 500 \text{ mA}$	—	—	100	mV
Peak output current	I_{PEAK}	$V_{IN} = 6.0 \text{ V}$, The output current value when V_{OUT} decreases by 5% from its value at $I_{OUT} = 250 \text{ mA}$.	600	900	—	mA
Bias current under no load	I_{BIAS}	$V_{IN} = 6.0 \text{ V}$, $I_{OUT} = 0 \text{ mA}$	—	1.1	3.0	mA
Bias current fluctuation to input	$\Delta I_{BIAS(IN)}$	$V_{IN} = 6.0 \text{ V} \rightarrow 14.0 \text{ V}$, $I_{OUT} = 250 \text{ mA}$	-5	—	5	mA
Bias current fluctuation to load	$\Delta I_{BIAS(LOA)}$	$V_{IN} = 6.0 \text{ V}$, $I_{OUT} = 0 \text{ mA} \rightarrow 500 \text{ mA}$	—	—	25	mA
Standby consumption current	I_{STB}	$V_{IN} = 14.0 \text{ V}$, $V_{CONT} = 0 \text{ V}$	—	—	3.0	μA
Bias current before starting regulation	I_{RUSH}	$V_{IN} = 4.75 \text{ V}$, $I_{OUT} = 0 \text{ A}$	—	—	5	mA
Control terminal current	I_{CONT}	$V_{IN} = 6.0 \text{ V}$, $I_{OUT} = 250 \text{ mA}$ $V_{CONT} = 1.8 \text{ V}$	—	—	30	μA
Ripple rejection ratio 1	RR1	$V_{IN} = 7.0 \text{ V} \pm 1 \text{ V}$, $f = 120 \text{ Hz}$ $I_{OUT} = 100 \text{ mA}$	49.9	—	—	dB
Minimum input/output voltage difference 1	$V_{DIF(min)1}$	$V_{IN} = 5.1 \text{ V}$, $I_{OUT} = 250 \text{ mA}$	—	0.25	0.45	V
Minimum input/output voltage difference 2	$V_{DIF(min)2}$	$V_{IN} = 5.2 \text{ V}$, $I_{OUT} = 500 \text{ mA}$	—	—	0.8	V
Control terminal threshold high voltage	V_{CONTH}	$V_{IN} = 6.0 \text{ V}$	—	1.45	1.80	V
Control terminal threshold low voltage	V_{CONTL}	$V_{IN} = 6.0 \text{ V}$	0.50	0.70	—	V

• Design reference data

Note) The following values are typical and not guaranteed values.

Parameter	Symbol	Conditions	Min	Typ	Max	Unit
Ripple rejection ratio 2	RR2	$V_{IN} = 7.0 \text{ V} \pm 1 \text{ V}$, $f = 500 \text{ kHz}$ $I_{OUT} = 100 \text{ mA}$	—	30	—	dB
Output noise voltage	V_{NO}	$10 \text{ Hz} \leq f \leq 100 \text{ kHz}$, $I_{OUT} = 100 \text{ mA}$ $V_{IN} = 6.0 \text{ V}$, $CNR = 1 \mu\text{F}$	—	40	—	$\mu\text{V[rms]}$
Output voltage temperature coefficient	$\frac{dV_{OUT}}{dT_a}$	$V_{IN} = 6.0 \text{ V}$, $I_{OUT} = 5 \text{ mA}$ $-30^\circ\text{C} \leq T_a \leq +125^\circ\text{C}$	—	± 40	—	ppm/ $^\circ\text{C}$
Output short-circuit current	I_{OSHORT}	$V_{IN} = 14.0 \text{ V}$, $V_{OUT} = \text{GND}$	—	300	—	mA
Overheat protection operating temperature	T_{JTH}	$V_{IN} = 6.0 \text{ V}$, $I_{OUT} = 5 \text{ mA}$	—	150	—	$^\circ\text{C}$

■ Electrical Characteristics at $T_a = 25^\circ\text{C}$ (continued)

• AN80M51RSP (5.1 V type)

Unless otherwise specially provided, shorten each test time (within 10 ms) so that the test is conducted under the condition that the drift due to the temperature increase in the chip junction part can be neglected. $C_{IN} = 3.3 \mu\text{F}$, $CNR = \text{Open}$, $C_{OUT} = 33 \mu\text{F}$

Parameter	Symbol	Conditions	Min	Typ	Max	Unit
Output voltage	V_{OUT}	$V_{IN} = 6.1 \text{ V}$, $I_{OUT} = 250 \text{ mA}$	4.947	5.1	5.253	V
Line regulation	REG_{IN}	$V_{IN} = 6.1 \text{ V} \rightarrow 14.0 \text{ V}$, $I_{OUT} = 250 \text{ mA}$	—	—	51	mV
Load regulation	REG_{LOA}	$V_{IN} = 6.1 \text{ V}$, $I_{OUT} = 0 \text{ mA} \rightarrow 500 \text{ mA}$	—	—	102	mV
Peak output current	I_{PEAK}	$V_{IN} = 6.1 \text{ V}$, The output current value when V_{OUT} decreases by 5% from its value at $I_{OUT} = 250 \text{ mA}$.	600	900	—	mA
Bias current under no load	I_{BIAS}	$V_{IN} = 6.1 \text{ V}$, $I_{OUT} = 0 \text{ mA}$	—	1.1	3.0	mA
Bias current fluctuation to input	$\Delta I_{BIAS(IN)}$	$V_{IN} = 6.1 \text{ V} \rightarrow 14.0 \text{ V}$, $I_{OUT} = 250 \text{ mA}$	-5	—	5	mA
Bias current fluctuation to load	$\Delta I_{BIAS(LOA)}$	$V_{IN} = 6.1 \text{ V}$, $I_{OUT} = 0 \text{ mA} \rightarrow 500 \text{ mA}$	—	—	25	mA
Standby consumption current	I_{STB}	$V_{IN} = 14.0 \text{ V}$, $V_{CONT} = 0 \text{ V}$	—	—	3.0	μA
Bias current before starting regulation	I_{RUSH}	$V_{IN} = 4.845 \text{ V}$, $I_{OUT} = 0 \text{ A}$	—	—	5	mA
Control terminal current	I_{CONT}	$V_{IN} = 6.1 \text{ V}$, $I_{OUT} = 250 \text{ mA}$ $V_{CONT} = 1.8 \text{ V}$	—	—	30	μA
Ripple rejection ratio 1	RR1	$V_{IN} = 7.1 \text{ V} \pm 1 \text{ V}$, $f = 120 \text{ Hz}$ $I_{OUT} = 100 \text{ mA}$	49.8	—	—	dB
Minimum input/output voltage difference 1	$V_{DIF(min)1}$	$V_{IN} = 5.2 \text{ V}$, $I_{OUT} = 250 \text{ mA}$	—	0.25	0.45	V
Minimum input/output voltage difference 2	$V_{DIF(min)2}$	$V_{IN} = 5.3 \text{ V}$, $I_{OUT} = 500 \text{ mA}$	—	—	0.8	V
Control terminal threshold high voltage	V_{CONTH}	$V_{IN} = 6.1 \text{ V}$	—	1.45	1.80	V
Control terminal threshold low voltage	V_{CONTL}	$V_{IN} = 6.1 \text{ V}$	0.50	0.70	—	V

• Design reference data

Note) The following values are typical and not guaranteed values.

Parameter	Symbol	Conditions	Min	Typ	Max	Unit
Ripple rejection ratio 2	RR2	$V_{IN} = 7.1 \text{ V} \pm 1 \text{ V}$, $f = 500 \text{ kHz}$ $I_{OUT} = 100 \text{ mA}$	—	30	—	dB
Output noise voltage	V_{NO}	$10 \text{ Hz} \leq f \leq 100 \text{ kHz}$, $I_{OUT} = 100 \text{ mA}$ $V_{IN} = 6.1 \text{ V}$, $CNR = 1 \mu\text{F}$	—	40	—	$\mu\text{V[rms]}$
Output voltage temperature coefficient	$\frac{dV_{OUT}}{dT_a}$	$V_{IN} = 6.1 \text{ V}$, $I_{OUT} = 5 \text{ mA}$ $-30^\circ\text{C} \leq T_a \leq +125^\circ\text{C}$	—	± 40	—	ppm/ $^\circ\text{C}$
Output short-circuit current	I_{OSHORT}	$V_{IN} = 14.0 \text{ V}$, $V_{OUT} = \text{GND}$	—	300	—	mA
Overheat protection operating temperature	T_{JTH}	$V_{IN} = 6.1 \text{ V}$, $I_{OUT} = 5 \text{ mA}$	—	150	—	$^\circ\text{C}$

■ Electrical Characteristics at $T_a = 25^\circ\text{C}$ (continued)

• AN80M52RSP (5.2 V type)

Unless otherwise specially provided, shorten each test time (within 10 ms) so that the test is conducted under the condition that the drift due to the temperature increase in the chip junction part can be neglected. $C_{IN} = 3.3 \mu\text{F}$, $CNR = \text{Open}$, $C_{OUT} = 33 \mu\text{F}$

Parameter	Symbol	Conditions	Min	Typ	Max	Unit
Output voltage	V_{OUT}	$V_{IN} = 6.2 \text{ V}$, $I_{OUT} = 250 \text{ mA}$	5.044	5.2	5.356	V
Line regulation	REG_{IN}	$V_{IN} = 6.2 \text{ V} \rightarrow 14.0 \text{ V}$, $I_{OUT} = 250 \text{ mA}$	—	—	52	mV
Load regulation	REG_{LOA}	$V_{IN} = 6.2 \text{ V}$, $I_{OUT} = 0 \text{ mA} \rightarrow 500 \text{ mA}$	—	—	104	mV
Peak output current	I_{PEAK}	$V_{IN} = 6.2 \text{ V}$, The output current value when V_{OUT} decreases by 5% from its value at $I_{OUT} = 250 \text{ mA}$.	600	900	—	mA
Bias current under no load	I_{BIAS}	$V_{IN} = 6.2 \text{ V}$, $I_{OUT} = 0 \text{ mA}$	—	1.1	3.0	mA
Bias current fluctuation to input	$\Delta I_{BIAS(IN)}$	$V_{IN} = 6.2 \text{ V} \rightarrow 14.0 \text{ V}$, $I_{OUT} = 250 \text{ mA}$	-5	—	5	mA
Bias current fluctuation to load	$\Delta I_{BIAS(LOA)}$	$V_{IN} = 6.2 \text{ V}$, $I_{OUT} = 0 \text{ mA} \rightarrow 500 \text{ mA}$	—	—	25	mA
Standby consumption current	I_{STB}	$V_{IN} = 14.0 \text{ V}$, $V_{CONT} = 0 \text{ V}$	—	—	3.0	μA
Bias current before starting regulation	I_{RUSH}	$V_{IN} = 4.940 \text{ V}$, $I_{OUT} = 0 \text{ A}$	—	—	5	mA
Control terminal current	I_{CONT}	$V_{IN} = 6.2 \text{ V}$, $I_{OUT} = 250 \text{ mA}$ $V_{CONT} = 1.8 \text{ V}$	—	—	30	μA
Ripple rejection ratio 1	RR1	$V_{IN} = 7.2 \text{ V} \pm 1 \text{ V}$, $f = 120 \text{ Hz}$ $I_{OUT} = 100 \text{ mA}$	49.6	—	—	dB
Minimum input/output voltage difference 1	$V_{DIF(min)1}$	$V_{IN} = 5.3 \text{ V}$, $I_{OUT} = 250 \text{ mA}$	—	0.25	0.45	V
Minimum input/output voltage difference 2	$V_{DIF(min)2}$	$V_{IN} = 5.4 \text{ V}$, $I_{OUT} = 500 \text{ mA}$	—	—	0.8	V
Control terminal threshold high voltage	V_{CONTH}	$V_{IN} = 6.2 \text{ V}$	—	1.45	1.80	V
Control terminal threshold low voltage	V_{CONTL}	$V_{IN} = 6.2 \text{ V}$	0.50	0.70	—	V

• Design reference data

Note) The following values are typical and not guaranteed values.

Parameter	Symbol	Conditions	Min	Typ	Max	Unit
Ripple rejection ratio 2	RR2	$V_{IN} = 7.2 \text{ V} \pm 1 \text{ V}$, $f = 500 \text{ kHz}$ $I_{OUT} = 100 \text{ mA}$	—	30	—	dB
Output noise voltage	V_{NO}	$10 \text{ Hz} \leq f \leq 100 \text{ kHz}$, $I_{OUT} = 100 \text{ mA}$ $V_{IN} = 6.2 \text{ V}$, $CNR = 1 \mu\text{F}$	—	40	—	$\mu\text{V[rms]}$
Output voltage temperature coefficient	$\frac{dV_{OUT}}{dT_a}$	$V_{IN} = 6.2 \text{ V}$, $I_{OUT} = 5 \text{ mA}$ $-30^\circ\text{C} \leq T_a \leq +125^\circ\text{C}$	—	± 40	—	ppm/ $^\circ\text{C}$
Output short-circuit current	I_{OSHORT}	$V_{IN} = 14.0 \text{ V}$, $V_{OUT} = \text{GND}$	—	300	—	mA
Overheat protection operating temperature	T_{JTH}	$V_{IN} = 6.2 \text{ V}$, $I_{OUT} = 5 \text{ mA}$	—	150	—	$^\circ\text{C}$

■ Electrical Characteristics at $T_a = 25^\circ\text{C}$ (continued)

• AN80M53RSP (5.3 V type)

Unless otherwise specially provided, shorten each test time (within 10 ms) so that the test is conducted under the condition that the drift due to the temperature increase in the chip junction part can be neglected. $C_{IN} = 3.3 \mu\text{F}$, $CNR = \text{Open}$, $C_{OUT} = 33 \mu\text{F}$

Parameter	Symbol	Conditions	Min	Typ	Max	Unit
Output voltage	V_{OUT}	$V_{IN} = 6.3 \text{ V}$, $I_{OUT} = 250 \text{ mA}$	5.141	5.3	5.459	V
Line regulation	REG_{IN}	$V_{IN} = 6.3 \text{ V} \rightarrow 14.0 \text{ V}$, $I_{OUT} = 250 \text{ mA}$	—	—	53	mV
Load regulation	REG_{LOA}	$V_{IN} = 6.3 \text{ V}$, $I_{OUT} = 0 \text{ mA} \rightarrow 500 \text{ mA}$	—	—	106	mV
Peak output current	I_{PEAK}	$V_{IN} = 6.3 \text{ V}$, The output current value when V_{OUT} decreases by 5% from its value at $I_{OUT} = 250 \text{ mA}$.	600	900	—	mA
Bias current under no load	I_{BIAS}	$V_{IN} = 6.3 \text{ V}$, $I_{OUT} = 0 \text{ mA}$	—	1.1	3.0	mA
Bias current fluctuation to input	$\Delta I_{BIAS(IN)}$	$V_{IN} = 6.3 \text{ V} \rightarrow 14.0 \text{ V}$, $I_{OUT} = 250 \text{ mA}$	-5	—	5	mA
Bias current fluctuation to load	$\Delta I_{BIAS(LOA)}$	$V_{IN} = 6.3 \text{ V}$, $I_{OUT} = 0 \text{ mA} \rightarrow 500 \text{ mA}$	—	—	25	mA
Standby consumption current	I_{STB}	$V_{IN} = 14.0 \text{ V}$, $V_{CONT} = 0 \text{ V}$	—	—	3.0	μA
Bias current before starting regulation	I_{RUSH}	$V_{IN} = 5.035 \text{ V}$, $I_{OUT} = 0 \text{ A}$	—	—	5	mA
Control terminal current	I_{CONT}	$V_{IN} = 6.3 \text{ V}$, $I_{OUT} = 250 \text{ mA}$ $V_{CONT} = 1.8 \text{ V}$	—	—	30	μA
Ripple rejection ratio 1	RR1	$V_{IN} = 7.3 \text{ V} \pm 1 \text{ V}$, $f = 120 \text{ Hz}$ $I_{OUT} = 100 \text{ mA}$	49.5	—	—	dB
Minimum input/output voltage difference 1	$V_{DIF(min)1}$	$V_{IN} = 5.4 \text{ V}$, $I_{OUT} = 250 \text{ mA}$	—	0.25	0.45	V
Minimum input/output voltage difference 2	$V_{DIF(min)2}$	$V_{IN} = 5.5 \text{ V}$, $I_{OUT} = 500 \text{ mA}$	—	—	0.8	V
Control terminal threshold high voltage	V_{CONTH}	$V_{IN} = 6.3 \text{ V}$	—	1.45	1.80	V
Control terminal threshold low voltage	V_{CONTL}	$V_{IN} = 6.3 \text{ V}$	0.50	0.70	—	V

• Design reference data

Note) The following values are typical and not guaranteed values.

Parameter	Symbol	Conditions	Min	Typ	Max	Unit
Ripple rejection ratio 2	RR2	$V_{IN} = 7.3 \text{ V} \pm 1 \text{ V}$, $f = 500 \text{ kHz}$ $I_{OUT} = 100 \text{ mA}$	—	30	—	dB
Output noise voltage	V_{NO}	$10 \text{ Hz} \leq f \leq 100 \text{ kHz}$, $I_{OUT} = 100 \text{ mA}$ $V_{IN} = 6.3 \text{ V}$, $CNR = 1 \mu\text{F}$	—	40	—	$\mu\text{V[rms]}$
Output voltage temperature coefficient	$\frac{dV_{OUT}}{dT_a}$	$V_{IN} = 6.3 \text{ V}$, $I_{OUT} = 5 \text{ mA}$ $-30^\circ\text{C} \leq T_a \leq +125^\circ\text{C}$	—	± 40	—	ppm/ $^\circ\text{C}$
Output short-circuit current	I_{OSHORT}	$V_{IN} = 14.0 \text{ V}$, $V_{OUT} = \text{GND}$	—	300	—	mA
Overheat protection operating temperature	T_{JTH}	$V_{IN} = 6.3 \text{ V}$, $I_{OUT} = 5 \text{ mA}$	—	150	—	$^\circ\text{C}$

■ Application Notes

1. External compensation capacitor

Connect the input pin and ground pin with a 3.3 μF capacitor and the output pin and ground pin with a 33 μF capacitor in order to keep the stability of the IC in operation. Make sure that the 3.3 μF capacitor is as close as possible to the input pin and ground pin while the 33 μF capacitor is as close to the output pin and ground pin as possible.

As the stability is affected by the parasitic capacitance and impedance of the PCB pattern, pay utmost attention to the PCB layout.

Select each capacitor in consideration of the ESR (equivalent series resistance) of the capacitor for the AN80MxxRSP Series conduct a full evaluation under the right operating conditions.

The ESR of an aluminum or tantalum electrolytic capacitor may increase at low temperatures. Therefore, it is recommended to connect a 0.1 μF to 0.47 μF capacitor with low internal impedance, such as a multi-layer ceramic capacitor, in parallel to each capacitor.

Output current — Output capacitor ESR (equivalent series resistance)

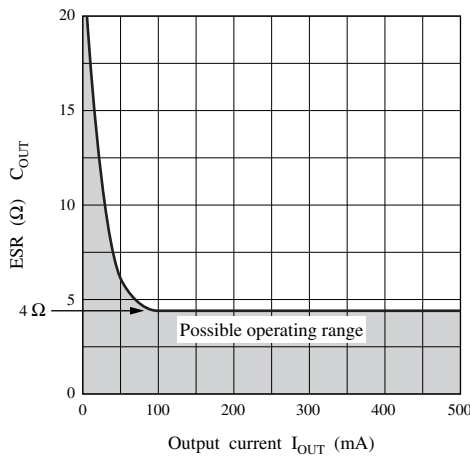

2. P_D — T_a curves of SP-5SU

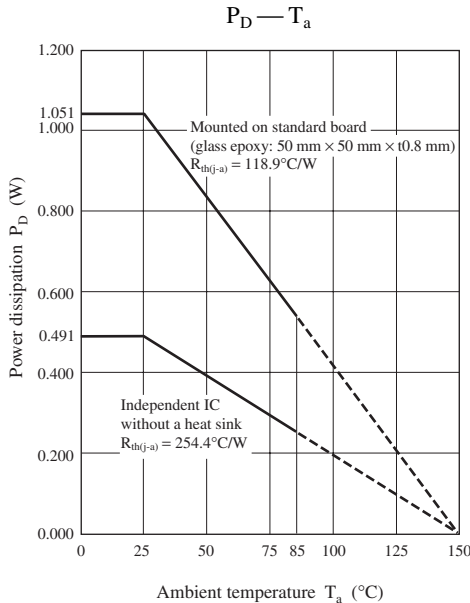

■ Application Notes (continued)

3. Main characteristics

- AN80MxxRSP series

Bias current under no load, bias current fluctuation to load

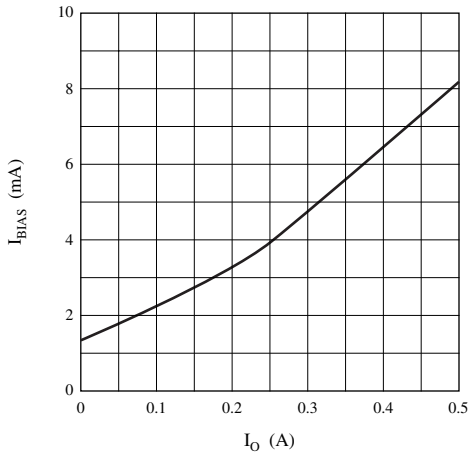

Peak output current

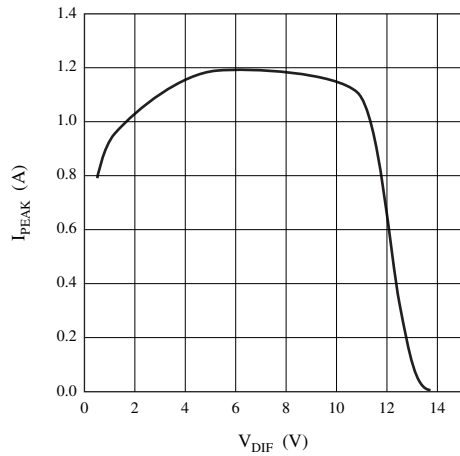

Minimum input/output voltage difference

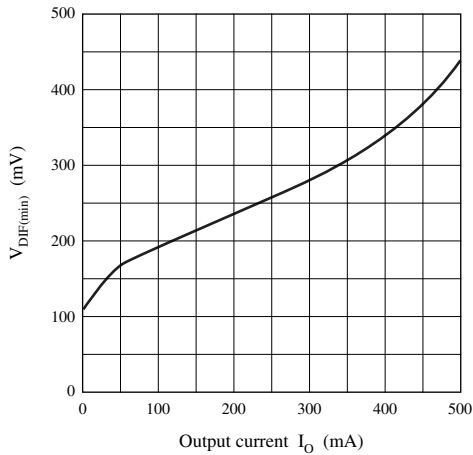

Output voltage temperature characteristic

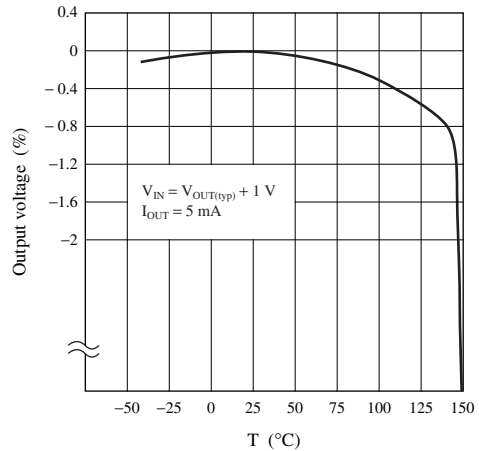

- AN80M18RSP

$I_B - V_{IN}$

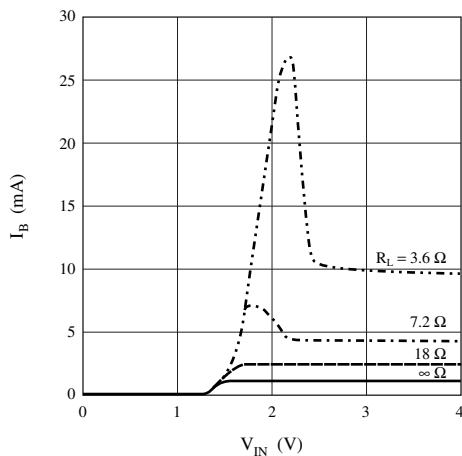

$V_O - I_O$

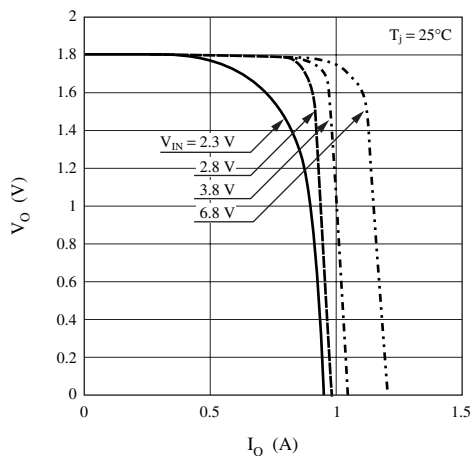

■ New Package Dimensions (Unit: mm)

- SP-5SUA (Lead-free package)

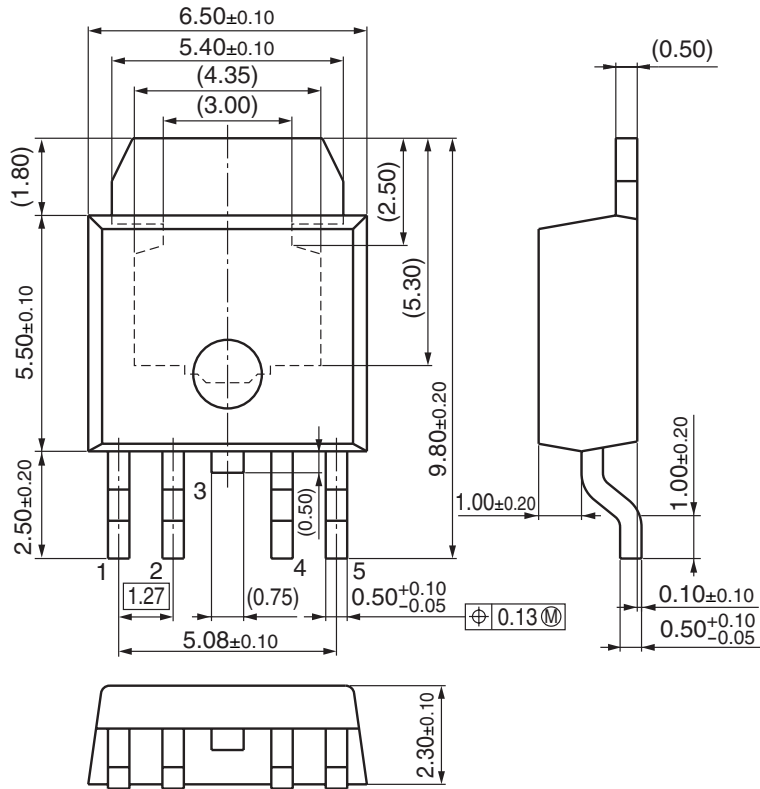

Request for your special attention and precautions in using the technical information and semiconductors described in this material

- (1) An export permit needs to be obtained from the competent authorities of the Japanese Government if any of the products or technologies described in this material and controlled under the "Foreign Exchange and Foreign Trade Law" is to be exported or taken out of Japan.
- (2) The technical information described in this material is limited to showing representative characteristics and applied circuit examples of the products. It does not constitute the warranting of industrial property, the granting of relative rights, or the granting of any license.
- (3) The products described in this material are intended to be used for standard applications or general electronic equipment (such as office equipment, communications equipment, measuring instruments and household appliances).
Consult our sales staff in advance for information on the following applications:
 - Special applications (such as for airplanes, aerospace, automobiles, traffic control equipment, combustion equipment, life support systems and safety devices) in which exceptional quality and reliability are required, or if the failure or malfunction of the products may directly jeopardize life or harm the human body.
 - Any applications other than the standard applications intended.
- (4) The products and product specifications described in this material are subject to change without notice for reasons of modification and/or improvement. At the final stage of your design, purchasing, or use of the products, therefore, ask for the most up-to-date Product Standards in advance to make sure that the latest specifications satisfy your requirements.
- (5) When designing your equipment, comply with the guaranteed values, in particular those of maximum rating, the range of operating power supply voltage and heat radiation characteristics. Otherwise, we will not be liable for any defect which may arise later in your equipment.
Even when the products are used within the guaranteed values, redundant design is recommended, so that such equipment may not violate relevant laws or regulations because of the function of our products.
- (6) When using products for which dry packing is required, observe the conditions (including shelf life and after-unpacking standby time) agreed upon when specification sheets are individually exchanged.
- (7) No part of this material may be reprinted or reproduced by any means without written permission from our company.

Please read the following notes before using the datasheets

- A. These materials are intended as a reference to assist customers with the selection of Panasonic semiconductor products best suited to their applications.
Due to modification or other reasons, any information contained in this material, such as available product types, technical data, and so on, is subject to change without notice.
Customers are advised to contact our semiconductor sales office and obtain the latest information before starting precise technical research and/or purchasing activities.
- B. Panasonic is endeavoring to continually improve the quality and reliability of these materials but there is always the possibility that further rectifications will be required in the future. Therefore, Panasonic will not assume any liability for any damages arising from any errors etc. that may appear in this material.
- C. These materials are solely intended for a customer's individual use.
Therefore, without the prior written approval of Panasonic, any other use such as reproducing, selling, or distributing this material to a third party, via the Internet or in any other way, is prohibited.

单击下面可查看定价，库存，交付和生命周期等信息

[>>Panasonic\(松下\)](#)