

TITLE	SPECIFICATIONS	PAGE	1 / 15
NAME	Impulse Heat Controller		AAD010100

1. Product Name/Model Number

Impulse Heat Controller (AAD010100)

Type	I/O Point	Power supply	Input spec.	Output spec.	Thermocouple input	Calendar timer function	COM port	Model No.	Applicable DWG No. of the product spec.
Impulse Heat Controller	8/6	24V DC	24V DC (Common Polarities + & - common) 8	Tr (NPN): 5 Relay: 1	1 point	Available	RS232C	AAD010100	AAD010100

F355 (PID) operation is improving in the function.(Ver.1.2 or higher)
Integral time (Ti) and derivative (Td) time can be set up per 0.01 seconds.

Control mode	Value of [S]		内容
	Auto-tuning Not executed	Auto-tuning Executed	Integral time (Ti) : setting range Derivativ time (Td): setting range
Derivative type (PI-D)	Reverse	H0	Ti : K1 to K30000 (0.1 to 3000 sec., 0.1sec. setting)
	Forward	H1	
Proportion-derivative (I-PD)	Reverse	H2	Td: K0~K10000 (0 to 1000 sec., 0.1sec. setting)
	Forward	H3	
Derivative type (PI-D)	Reverse	H410	Ti : K1 to K30000 (0.01 to 300 sec., 0.01sec. setting)
	Forward	H411	
Proportion-derivative (I-PD)	Reverse	H412	Td: K0~K10000 (0 to 100 sec., 0.01sec. setting)
	Forward	H413	

1) Phase control relation unit

Product Name	Contents	Model No.
Phase detection unit	AC input 100 to 240 V AC	AAD02010

2) Thermocouple film type

Product Name	Contents	Model No.	Applicable DWG No. of the product spec.
Thermocouple film type (5-pack)	K type, Class 2 D=0.127mm, L=1m Element resistance 80Ω/1m Polyimide coating	AAD01900	AAD01900

The measurement part of the thermocouple is insulated with the polyimide film with silicon adhesive.

Panasonic Electric Works Co., Ltd.	Designed:	Approved:
	Checked:	Date: 16.Feb.2010

TITLE	SPECIFICATIONS	PAGE	2 /15
NAME	Impulse Heat Controller		AAD010100

3) Programming devices and software

Control FPWIN GR *Note 1	English-language menu (Full)	AFPS10520
	English-language menu (Small)	AFPS11520
Control FPWIN Pro	English-language menu (Full)	AFPS50560
	English-language menu (Small)	AFPS51560

* Select "FP-e" for a PLC Type.

* Refer to the individual specifications and manuals for the details.

*Note 1: Version 2.2 or higher

4) Cables, repairing components, etc.

FP PC cable (M5 type)	Cable length: 3 m	Round pin - D-sub 9-pin	AFC8503
		Round pin - D-sub 9-pin straight type	AFC8503S
Terminal block driver	Used for connecting with a Phoenix terminal block.		AFP0806
Panel mounting frame	Used for mounting a unit on a panel (supplied with a unit).		ATA4811
Rubber gasket	Used for mounting a unit on a panel (supplied with a unit).		ATC18002
Protective cover	Used for protecting a front display. (common to Timer/Counter)		AQM4803

2. Configurations and Dimensions

Refer to the attached product specifications drawing.

3. Product System Configurations

1) Impulse Heat Controller

14 points (Input: 8, Output: 6)

2) I/O number allocation

Item	Description
External input X contact point	X0 to X7
External output Y contact point	Y0 to Y5
Temperature input	WX2
Front operation switch	X30 to X37 (S and I modes) X38 to X3F (All modes)

Note 1) For the allocation of the front operation switch, refer to "4-9 Front Operation Switch."

Panasonic Electric Works Co., Ltd.	Date : 16.Feb.2010
------------------------------------	--------------------

TITLE SPECIFICATIONS		PAGE 3 /15
NAME Impulse Heat Controller		AAD010100
4. Specifications		
1) General specifications		
Item	Description	
Rated voltage	24V DC	
Operating voltage range	21.6 to 26.4V DC	
Allowed momentary power off time	10 ms	
Ambient temperature	0 to +55°C	
Storage temperature	-20 to +70°C	
Ambient humidity	30 to 85%RH (at 25°C non-condensing)	
Storage humidity	30 to 85%RH (at 25°C non-condensing)	
Breakdown voltage	Between the isolated circuits: 500V AC for 1 min. Between (3) Output terminal (Y5, COM) and other insulated circuit: 1500V AC for 1 min. (Cut-off current 10 mA. Exclude varistor)	Isolated circuits (1) Power supply terminal, functional earth, input terminals (A1) COM. (RS232C) terminal (2) Input terminals (X0 to X7, COM) (3) Output terminals (+, -, Y0 to Y4) (4) Output terminals (Y5, COM)
Insulation resistance	Between the insulated circuits: 100 MΩ or more (measured with 500 V DC)	
Vibration resistance	10 to 55 Hz, 1 cycle/min. Double amplitude: 0.75 mm for 10 min. on X, Y and Z axes	
Shock resistance	98 m/s ² or more for 4 times on X, Y and Z axes	
Noise resistance	1000V (p-p) with pulse widths 50 ns 1 μs (based on in-house measurements)	
Operating condition	Free from corrosive gases and excessive dust	
Protection	IP66-compliant front section (Only when a rubber gasket is used.)	
Weight	Approx. 130 g	
2) Current consumption		
Item	Current consumption (24V DC)	
FP Impulse Heat Controller	200 mA or less	
Panasonic Electric Works Co., Ltd.		Date : 16.Feb.2010

3) Control specifications

Item	Description
Programming method	Relay symbol
Control method	Cyclic operation
Input memory area (X)	13 words (WX0 - WX12)
External input (X)	8 points (X0 - X7)
Front switch input (X)	8 points (X30 - X37 , X38 - X3F) For mode switching:1 point For screen switching:1 point For data setting or external input:6 points
Output memory area (Y)	13 words (WY0 - WY12) ^{Note 1)}
External output (Y)	6 points (Y0 - Y5)
Program download / upload	Only download to PLC
Program memory	Built-in EEP ROM (Backup battery is not required.)
Program capacity	2720 steps
Basic instruction	83
High-level instruction	168
Operation speed	0.9 μ s/step (basic instruction) ^{Note 2)}
I/O update and Base time	Typical 2 ms Max. 10 ms ^{Note 3)}
Internal relay (R)	1008 points (R0 - R62F)
Special internal relay (R)	64 points (R9000 - R903F)
Timer/Counter (T/C)	144 points
Data register (DT)	1660 words (DT0 - DT1659)
Special data register (DT)	112 words (DT9000 - DT9111)
Index register (IX, IY)	2 points
Differential points	Not limited
Master control relay (MCR)	32 points
Number of labels (JMP+LOOP)	64 labels
Number of step ladder	128 stages
Number of subroutines	16 subroutines
Interrupt program	7 programs (External: 6 points, Internal 1 point)
Self-diagnosis functions	Watchdog timer, program syntax check
PWM output	Frequency: 0.15 Hz to 1 kHz Duty : 0.1 % to 99.9 %
Pulse catch / interrupt input	6 points in total
Periodical interrupt	0.5 ms to 30 s
Tool port (RS232C)	Baud rate: 9600/19200 bit/s
COM. Port ^{*Note4)}	RS232C
Constant scan	Available
Flash ROM backup	Program, system register
Internal relay/ Timer/ Data register	32 bytes (fixed area)
Battery backup	Memory stored in the maintenance area of the system register (This can be used only when a battery is loaded.) ^{*Note 5)}
Battery life	220 days or more ^{*Note 6)} Actual usage value: 870 days at 25°C Periodic battery replacement interval: 1 year (These values apply when no power is supplied at all.)
Calendar timer function	Available ^{*Note 7)} Accuracy: 200 sec. error per month (0°C) 70 sec. error per month (25°C) 240 sec. error per month (55°C)
Password	Available

TITLE	SPECIFICATIONS	PAGE	5 / 15
NAME	Impulse Heat Controller		AAD010100

Notes:

- *1) WY12 is used for temperature conversion processing. Don't use WY12 then in others.
WY12=K0, K1: 18 ms, WY12=K2: 36 ms, WY12=K3: 54 ms, WY12=K4: 72 ms, WY12=K5: 90 ms, WY12=K6: 108ms
- *2) Be careful for a scanning time not to exceed 36 ms.
- *3) The time takes longer every 18 ms.
- *4) Resend process is recommended when communication is performed using the COM. port.
RS232C driver IC of the COM. port is perfectly compliant with the EIA/TIA-232E and CCITT V.28 standards.
- *5) If the maintenance area is set when the power is turned on with the battery loaded, the data value becomes irregular because 0 clearing is not performed.
- *6) Install a new battery within a minute after the old battery is removed.
- *7) Time for the calendar timer function model is backed up by the battery. Therefore, the calendar timer cannot be used when the battery is not loaded in the unit.
The value is not fixed in the initial status. Write the appropriate value using the programming tool.

4) Communication specifications of the tool port

Factory settings

Baud rate	Data length	Parity	Stop bit
9600 bit/s	8 bit	Odd number	1 bit

5) Communication specifications of the COM. port

Factory settings

Operation	Baud rate	Data length	Parity	Stop bit	Beginning code	Ending code
Computer link	9600 bit/s	8 bit	Odd number	1 bit	STX (N/A)	CR

a) COM. port communication specifications

COM. port type	RS232C ^{*Note 1}
Isolation status with the internal circuit	Non-isolated
Transmission distance	15m
Baud rate	300,600,1200,2400,4800,9600,19200 bit/s
Communication method	Half-duplex
Synchro system	Synchronous communication method
Transmission format	Stop bit: 1 bit / 2 bit
	Parity: Not available / Available (Odd number / Even number)
	Data length 7 bit / 8 bit
	Beginning code: STX available / STX not available
	Ending code: CR / CR+LF / not available / ETX
Data output order	Starting from 0 bit per character
Communication mode	<ul style="list-style-type: none"> •General-purpose communication •Computer link •MODBUS Slave RTU

Notes:

- *1) For RS232C wiring, be sure to use shield wires for higher noise immunity.

Panasonic Electric Works Co., Ltd.	Date : 16.Feb.2010
------------------------------------	--------------------

TITLE	SPECIFICATIONS	PAGE	6 /15
NAME	Impulse Heat Controller		AAD010100

6) Input specifications

a) DC input specifications

Item	Description
Number of input	8 points
Insulation method	Optical coupler
Rated input voltage	24V DC
Operating voltage range	21.6 to 26.4V DC
Rated input current	Approx. 4.3 mA
Input points per common	8 points/common (Either the positive or negative of the input power supply can be connected to a common terminal.)
Min. ON voltage/ON current	19.2V or less / 4 mA
Max. OFF voltage/OFF current	2.4V or more / 1 mA
Input impedance	Approx. 5.1 k Ω (X0, X1), Approx. 5.6 k Ω (X2 to X7)
Response time	OFF to ON 50 μ s or less (X0, X1) ^{Note 1} 100 μ s or less (X2 to X5) ^{Note 1} 2 ms or less (X6, X7)
	ON to OFF 50 μ s or less (X0, X1) ^{Note 1} 100 μ s or less (X2 to X5) ^{Note 1} 2 ms or less (X6, X7)
Operation indicator	LCD display (I/O monitor mode)

*Note 1) X0 to X5 are for high-speed counter input. The response time is fast, and chattering and noise may be received as the input signal when used as the normal input. Therefore, the timer setting is recommended using the ladder program.

The specifications above is available when rated input voltage is at 24V DC and the temperature is at 25°C.

b) Thermocouple input specifications

Item	Description
Number of input	1 points (CH1: WX2)
Temperature sensor type	Thermocouple type K
Input temperature range	- 30.0 to 580.0 °C ^{Note 1} (- 22 to 1076 °F)
Accuracy	$\pm 0.5\%$ FS ± 1.5 °C (FS = -30 to 580 °C)
Resolution	0.1 °C
Conversion time	18 ms ^{Note 2}
Insulation method	Between internal circuit and thermocouple input circuit: non-insulated ^{Note 3}
Detection function of wire disconnection	Available

*1) Temperature can be measured up to 600 °C (1112 °F). When the measured temperature exceeds 600 °C (1112 °F) or the thermocouple wiring is disconnected, "K20000" is written to the register.

*2) Temperature conversion for thermocouple input is performed every 18 ms. The conversion data is updated on the internal data register after the scan has been completed.

*3) The internal circuit and thermocouple input circuit are not insulated. Therefore, use the non-grounding type thermocouples and sheath tubes.

Notes:

- To prevent the influence of noise, use the shielded thermocouples and compensating lead wires and ground them. When the shielded types are not used, thermocouples and compensating lead wires should be used less than 10 m.
- When the lead wire of the thermocouple is extended, be sure to use compensating lead wires according to the thermocouple type.
- After the power is supplied, it takes about 2 seconds until the input processing is completed. Therefore, the input data is necessary to be valid after the temperature input completion flags X4F (CH1) turn ON.
- 1 to 50 times (Average) can be set using the system register 409. The initial setting is "0." (Average: 20 times) Set the average number to prevent the fluctuation of the thermocouple input value.
- For accurate temperature measurement, it is recommend to warm up the unit for 30 minutes after the power is supplied.
- Connecting/disconnecting the thermocouple input terminal block while the thermocouple unit is ON will lower the accuracy temporarily. In that case, it is recommended to warm up the unit for at least 15 minutes.
- A rapid temperature change in the thermocouple unit might change the temperature data temporarily.
- Prevent a direct air (wind) from the cooling fan built in the control panel etc. The direct air (wind) to the unit will lower the accuracy.
- The wire resistance of the thermocouple to be used should not be over 100 Ω .

Panasonic Electric Works Co., Ltd.	Date : 16.Feb.2010
------------------------------------	--------------------

7) Output specifications

a) Transistor output specifications (For Y0 to Y4)

Item		Description (NPN)
Number of output		5 points
Insulation method		Optical coupler
Output type		Open collector
Rated load voltage		5 to 24V DC ^{Note 1}
Operating load voltage range		4.75 to 26.4V DC
Max. load current		0.5 A
Max. surge current		1 A
Output points per common		5 points/common
OFF state leakage current		100 μA or less
ON state Max. voltage drop		1.5V or less
Response time	OFF to ON	50 μs or less (For Y0 and Y1) 1 ms or less (For Y2,Y3 and Y4)
	ON to OFF	50 μs or less (For Y0 and Y1) 1 ms or less (For Y2,Y3 and Y4)
External power supply (For driving internal circuit)	Voltage	21.6 to 26.4V DC
	Current ^{Note 2}	6 mA/point (For Y0 and Y1) 3 mA/point (For Y2 to Y4)
Surge absorber		Zener diode
Operation indicator		LCD display (I/O monitor mode)

Note 1

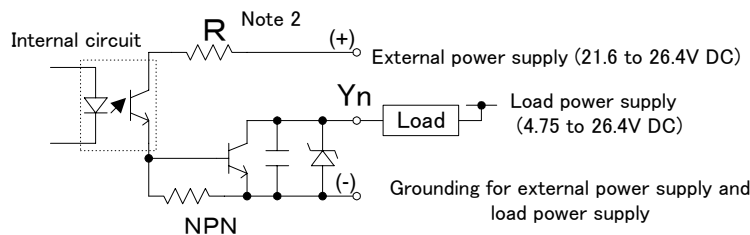

Note 2 Resistance ("R" in the Note 1 diagram above) is different in Y0 to Y1 and Y2 to Y4.

b) Relay output specifications (Y5)

Item		Description
Number of output		1 point
Output type		1a
Rated control capacity		2 A 250V AC, 2 A 30V DC (at resistive load)
Output points per common		1point / common
Response time	OFF to ON	Approx. 10 ms
	ON to OFF	Approx. 8 ms
Expected Life	Mechanical	Min. 20,000,000 operations (at 180 cpm)
	Electrical	Min. 100,000 operations (at 20 cpm , rated load)
Surge absorber		None
Operation indicator		LCD display (I/O monitor mode)

8) Display section specifications

Item	Description
Data display	5 digits with a decimal point. (Minus sign can also be used.) 7-segment, color selectable display (Green, red, or orange)
Mark display	SV PV (Green, red, or orange) ● °F °C h m s (Green)
Display mode	4 modes (Green) N: Normal mode----Simple characters, data display, data setting/data input switch S: Switch mode ----Simple characters, data setting/PLC external input switch R: Register mode----Internal data, timer/counter value reading and writing modes I : I/O monitor mode----I/O status display mode
Screen No.	1 2 (Green)
Status display	LOCK, RUN and PROG. (Green) ERR ALARM (Red)
Switch input	8 points For mode switching 1 point For screen switching 1 point For data setting or external input 6 points *Refer to the input address (4-9 below) for external input.
Display	Negative backlight LCD (Colors in the numerical section can be changed: green, red, or orange)
Size of the characters	7-segment 6.7 mm } LOCK PV SV 1.6 mm } ERR 1.4 mm N S R I 1.7 mm } ALARM ● °F °C h m s 1.6 mm

9) Front operation switch (External input address)

When the front operation switch is used for external input, use the allocated addresses as shown below.

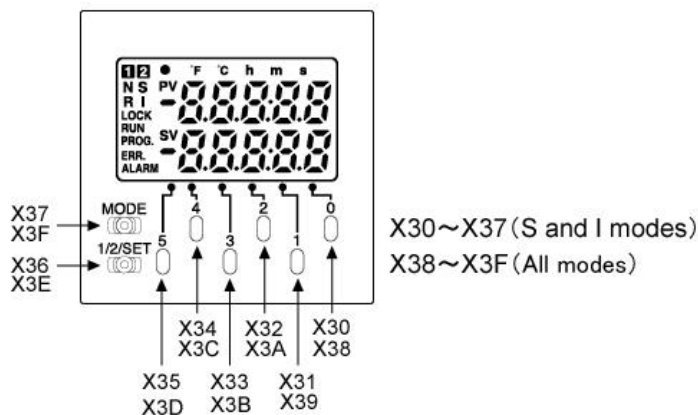

TITLE SPECIFICATIONS	PAGE 9 /15
NAME Impulse Heat Controller	AAD010100
<p>5. Safety Precautions Read and understand this specifications, instruction manual, installation manual and catalog to make proper use of the product.</p> <p>WARNING If critical situations that could lead to user's death or serious injury is assumed by mishandling of the product:</p> <ul style="list-style-type: none"> -Always take precautions to ensure the overall safety of your system, so that the whole system remains safe in the event of failure of this product or other external factor. -Do not use this product in areas with inflammable gas. It could lead to an explosion. -Exposing this product to excessive heat or open flames could lead to damage to the lithium battery or other electronic parts <p>CAUTION If critical situations that could lead to user's injury or only property damage is assumed by mishandling of the product.</p> <ul style="list-style-type: none"> -To prevent abnormal exothermic heat or smoke generation, use this product at the values less than the maximum of the characteristics and performance that are assure in these specifications. -Do not dismantle or remodel the product. It could lead to excessive exothermic heat or smoke generation. -Do not touch the terminal while turning on electricity. It could lead to an electric shock.. -Use the external devices to function the emergency stop and interlock circuit. -Connect the wires or connectors securely. The loose connection might lead to abnormal exothermic heat or smoke generation -Do not allow foreign matters such as liquid, flammable materials, metals to go into the inside of the product. It might lead to exothermic heat or smoke generation. -Do not undertake construction (such as connection and disconnection) while the power supply is on. It could lead to an electric shock. <p>6. Handling Instructions</p> <p>1) Installation Environment</p> <ul style="list-style-type: none"> •Ambient temperatures:0 ~ +55 °C •Ambient humidity: 10% to 95% RH (at 25°C, non-condensing) •Keep the height below 2000m. •For use in pollution Degree 2 environment. •Do not use it in the following environments. <ul style="list-style-type: none"> - Direct sunlight - Sudden temperature changes causing condensation. - Inflammable or corrosive gas. - Excessive airborne dust, metal particles or saline matter. - Benzine, paint thinner, alcohol or other organic solvents or strong alkaline solutions such as ammonia or caustic soda. - Direct vibration, shock or direct drop of water. - Influence from power transmission lines, high voltage equipment, power cables, power equipment, radio transmitters,or any other equipment that would generate high switching surges.(100mm or more) <p>2) About static electricity</p> <ul style="list-style-type: none"> - Do not touch connector pins directly to prevent static electricity from causing damage. - Always rid yourself of any static electricity before handling this product. 	
Panasonic Electric Works Co., Ltd.	Date : 16.Feb.2010

3) Installation Instructions

Mounting space

- Do not mount the Controller above which generates large heat such as heaters, transformers, or large scale resistors.
- Always mount the Controller as shown below in order to prevent the generation of heat.
Do not mount the Controller vertically as shown below.

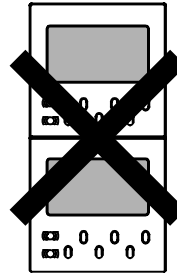
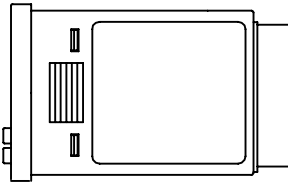

- Note that the ambient temperature and electrical voltage are restricted when the mounting panel is installed at the angle of 0 (level) to 60.

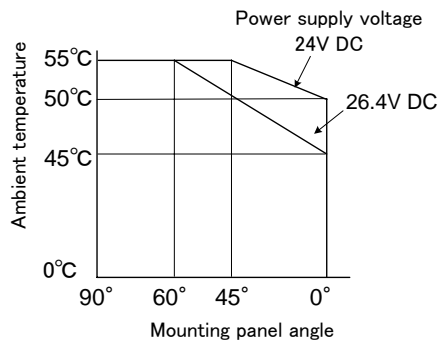
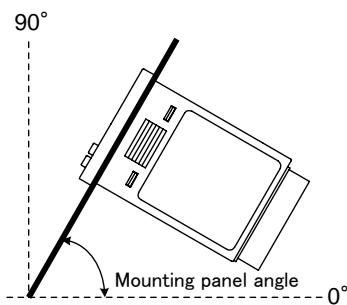

- Do not install the Controller as shown below to prevent abnormal heat generation in the Controller.

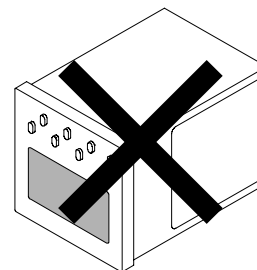
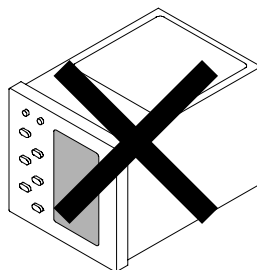
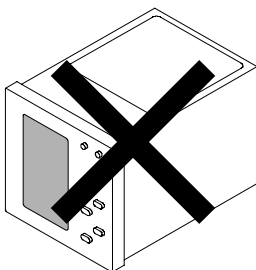

4) Mounting and Removing the Unit**Mounting the Unit**

Insert the Controller into the mounting panel opening from its front and mount the mounting frame from the unit's rear all the way not to have any space with the mounting panel. In addition, secure the mounting frame using screws.

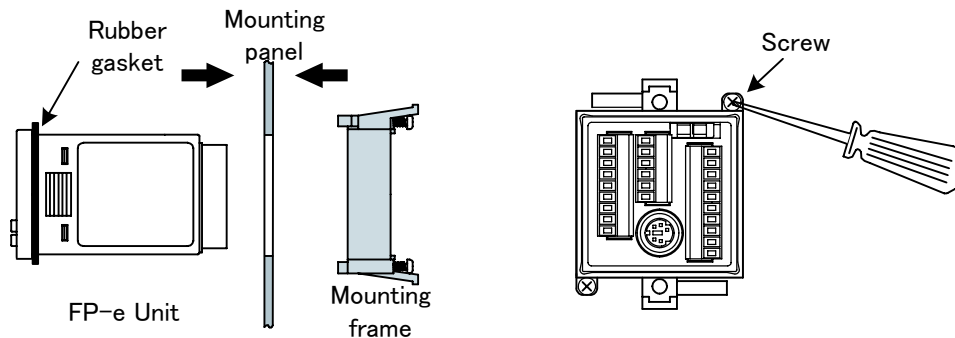
**Precautions for mounting the Unit**

The front of the Controller is waterproof, but do not forget to fix the mounting frame using screws to secure a Controller, rubber gasket and panel front in absolute contact with one another.

(Check that the both screws are tightened to the same extent and are stable. Tightening too much might remove the mounting frame.)

Always mount a Controller with a rubber gasket to keep the Unit front section's waterproof. keep them in absolute contact with one another

Removing the Unit

Loosen the screws for the mounting frame. Then, pull outward the frame while widening the hooks.

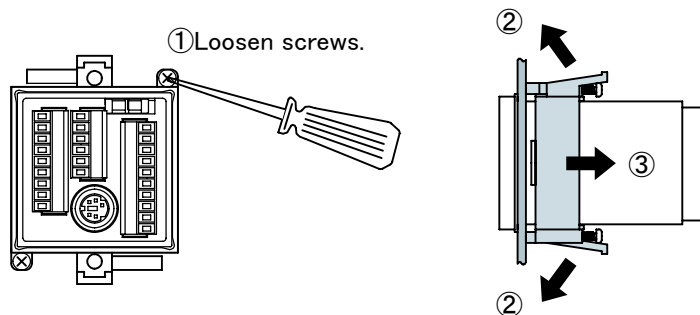

5) Mounting panel cut size (Unit: mm)

- Standard mounting panel cut size

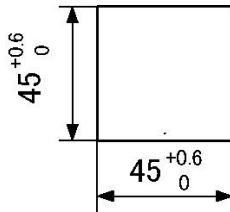

Mounting panel cut size is shown in the diagram on the left.
(Panel thickness : 1 to 5 mm)

- When using two or more units:
Make holes in the specified size as shown in the diagram on the right.

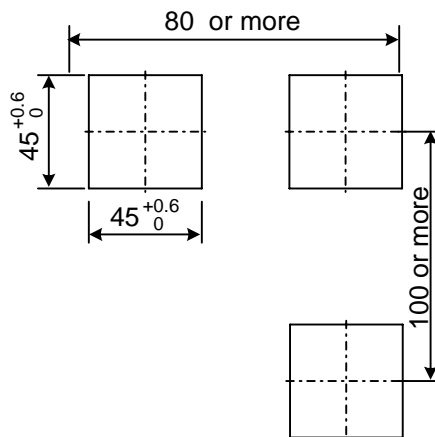

- When mounting units in a row
Units can be mounted horizontally in a row. In that case, however, waterproofing property on the unit will be lost.

When "n" units are mounted in a row, "A" should be:

$$A = (48 \times n - 2.5) \begin{matrix} +0.6 \\ 0 \end{matrix}$$

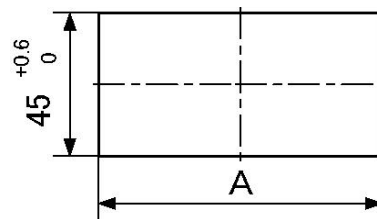

- When mounting the units horizontally in a row:

Mount the units oriented with the molded spring sections of the mounting frame facing upward and downward.

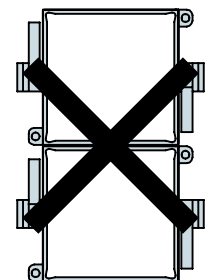
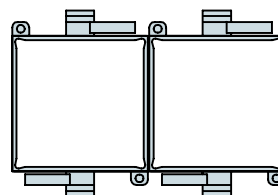

Note: Do not mount the units vertically in a row in order to prevent the generation of heat.

6) Suitable wires for the terminal block

Use suitable wires as shown below.

-Suitable wires (twisted wires)

Size	Nominal cross-sectional area
AWG#28 to 16	0.08 mm ² to 1.25 mm ²

7) Power supply wiring

- Twist the wires of the power supply cable.
- The Controller has sufficient noise immunity against the noise generated on the power line. However, it is recommended to take measures for reducing noise such as using an isolating transformer before supplying the power.
- Allocate an independent wiring for each power supplying line, input/output device and operating device.

8) Power supply sequence

In order to protect the power supply sequence, make sure to turn off the Controller before the input/output power supply. If the input/output power supply is turned off before the Controller, or if the Controller is not shut off momentarily, the Controller detects change of input level, and might conduct an unexpected operation.

9) Grounding

- Under normal condition, the inherent noise resistance is sufficient. However, under the environment that has excessive noise, ground the instrument to increase noise suppression.
- When conducting grounding, do not share a ground with the other devices, but provide an exclusive ground for each device.

○ Correct

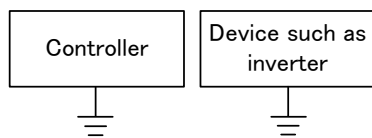

✗ Incorrect

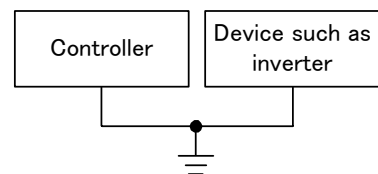

Note: Depending on use environment, grounding might cause a problem adversely.

<Example>

The power supply line of the Controller is connected to the function earth terminal through a varistor. If there is an irregular potential between the power supply line and the earth, the varistor may short out.

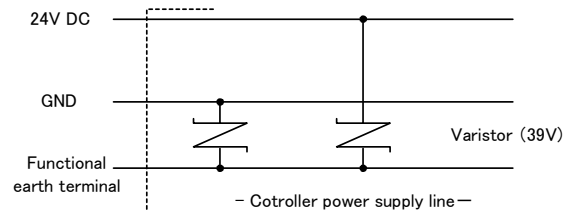

- Do not ground an Controller function earth terminal when grounding a plus (+) terminal of the power. In some computers, the SG terminal of RS232C port and connector shielding are connected. In addition, an Controller tool port shielding and function earth terminal are connected. When using the Controller with the plus terminal grounded, therefore, the minus terminal of the Controller and the function earth terminal are connected by hooking up with a computer. As a result, short circuit occurs which may lead to the breakage of the Controller and its neighboring parts.

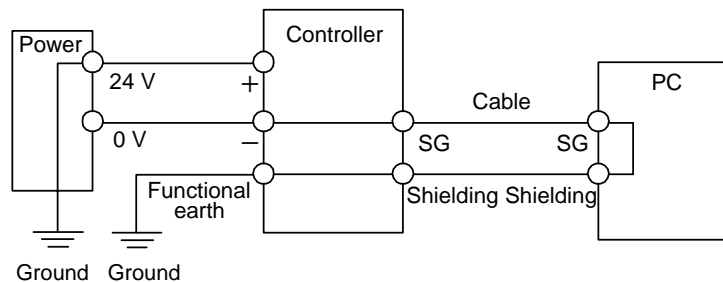

10) Voltage fluctuations

- When an Controller is used under the condition that the I/O voltage exceeds the specified value, the input /output may not be normally operated. If the Unit might be used in such a condition, it is recommended to add the interlock program (for overtime monitoring) for the input operation.

11) Input/Output wiring

- Regarding the wiring of the input/output, select a suitable diameter of electric wire depending on a current-carrying capacity.
- Install the input and output wirings separately from each other.
- Separate the input/output wire from the power and high voltage wires by at least 100 mm.
- The tightening torque of terminal screws for the terminal type shall be 0.22 to 0.25 N·m [2.3~2.5 kgf·cm] or less.
- Suitable wires (twisted wires): AWG#24 to 16. Nominal cross-sectional area: 0.2 mm² to 1.25 mm²

12) Input/Output device wiring

- The input contact point might not turn off, when current leaks from the input button. In such a case, connect a bleeder resistor as shown below.

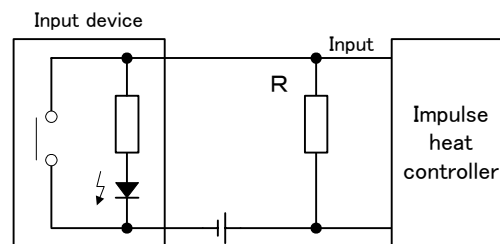

- For opening/shutting an inductive load, a protection circuit should be connected in parallel to the output device as shown in the illustrations below. When opening/shutting the DC type inductive load by the relay output, be sure to connect a diode across the ends of the load. Whether the protection circuit is used or not will have a strong influence on contact life.

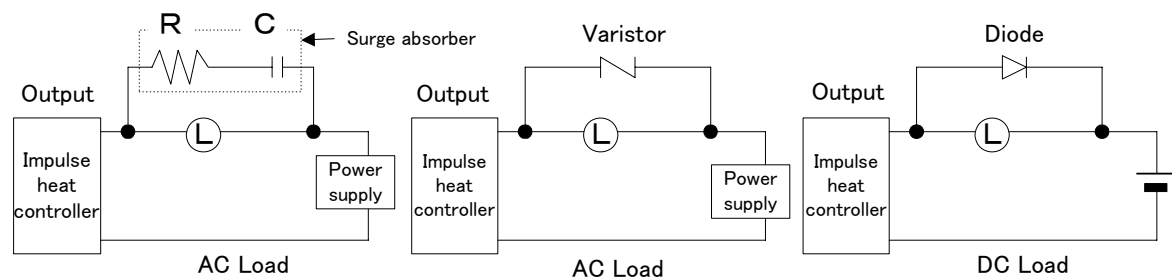
**13) COM. port wiring**

- Use the shielded wires for COM. port (RS232C). It is recommended to ground the shielded wires.

7.Termination of Production

- 1)PLEASE BE FOREWARNED: At some point in the future, this product will go out of production.
- 2)After the termination of production, although repair services will be provided for a period of seven years thereafter, we recommend that you secure spare parts beforehand to avoid delays in repair.

TITLE SPECIFICATIONS	PAGE 15 /15
NAME Impulse Heat Controller	AAD010100
<p>8. Special Remarks</p> <p>The product and specifications listed in this document are subject to change without notice as occasioned by the improvements that we introduce into our product. Consequently, when you consider the use of the product or when you place orders for the product, we ask you to contact one of our customer service representatives and check that the details listed in this document are commensurate with the most up-to-date information.</p> <p>We give the utmost care and attention to the quality of this product. However, to ensure safe, continuous and effective performance, we recommend that you:</p> <ol style="list-style-type: none"> 1) When our product is used beyond the range of the specifications, environment or conditions specified in this document, or when you are considering the use of our product in any conditions or an environment that is not specified in this document, or when you are considering the use of our product for particular purposes for which high reliability is required such as safety equipment and control systems used for the railroad, aviation or medical-care industries, you must contact one of our customer service representatives and obtain proper specification sheet. 2) Consult with us about the specifications of your own product, end users, environment and conditions of use, procedures for installation, etc.; 3) Take safety measures (such as double interlock, etc.) to ensure the safety of the whole system in which this product will be used, to avoid injury due to failure of this product or other external factor; and always use this product well below its limit and capacity mentioned in this document. 4) In connection with the product you have purchased from us or with the product delivered to your premises, promptly perform an acceptance inspection and in connection with the handling of our product both before and during the acceptance inspection, give full consideration to the control and preservation of our product. <p>Warranty period</p> <p>The Warranty Period for this product is 1 years from either the date of purchase or the date on which the product is delivered to the location specified by the Buyer.</p> <p>Extent of warranty</p> <p>In the event of any failure or defect in the product or non-conformity of specifications due to the reasons solely attributable to the Seller, Seller shall remedy such malfunctioning or defective product at its own cost in one of the following ways to be selected by SELLER: i) repair such product, (ii) replace such product, (iii) supply of replacement parts.</p> <p>However, this Warranty shall not cover the damages or defects that arise due to the reasons any of the followings.</p> <ol style="list-style-type: none"> 1 Specifications, standards or handling procedures specified by the Buyer. 2 Modifications to the structure, performance or specifications performed by a party other than the Seller after the date of purchase or the date on which the product is delivered. 3 Phenomena that could not have been foreseen with the technology that was put into practical use at the time of purchase. 4 Exceeding the ranges, conditions, circumstances or environment described in the Manuals or Specification sheet. 5 Damages that could be avoided if Seller's product have the functions and structures generally accepted in the industry, when incorporating the product in to Buyer's product. 6 Natural disasters or an Act of God. 7 Consumable goods such as batteries and relays, or optional accessories such as cables. <p>SELLER SPECIFICALLY DISCLAIMS ALL IMPLIED WARRANTIES OF MERCHANTABILITY AND/OR FITNESS FOR A PARTICULAR USE OR PURPOSE, AS WELL AS LIABILITY FOR INCIDENTAL, SPECIAL, INDIRECT, CONSEQUENTIAL OR OTHER DAMAGES RELATING TO THE PRODUCT.</p>	
Panasonic Electric Works Co., Ltd.	Date : 16.Feb.2010

单击下面可查看定价，库存，交付和生命周期等信息

[>>Panasonic\(松下\)](#)