

## Metallized Polyester Film Capacitor

**ECQE(F)** series

**Non-inductive construction using metallized polyester film with flame retardant epoxy resin coating**



### Features

- Self-healing property
- Excellent electrical characteristics
- Flame retardant epoxy resin coating
- RoHS compliant

### Recommended applications

- General purpose usage  
※Please contact us when applications are CDI , ignitor etc.

### Explanation of part number

1	2	3	4	5	6	7	8	9	10	11	12																																			
<b>E</b>	<b>C</b>	<b>Q</b>	<b>E</b>							<b>F</b>																																				
Product code		Dielectric & construction		Rated voltage		Capacitance			Cap. Tol.	Suffix 1	Suffix 2																																			
				<table border="1"> <thead> <tr> <th>Code</th> <th>R.voltage</th> </tr> </thead> <tbody> <tr><td>1</td><td>100 V [DC]</td></tr> <tr><td>2</td><td>250 V [DC]</td></tr> <tr><td>4</td><td>400 V [DC]</td></tr> <tr><td>6</td><td>630 V [DC]</td></tr> <tr><td>10</td><td>1000 V [DC]</td></tr> <tr><td>12</td><td>1250 V [DC]</td></tr> <tr><td>1A</td><td>125 V [AC]</td></tr> <tr><td>2A</td><td>250 V [AC]</td></tr> </tbody> </table>		Code	R.voltage	1	100 V [DC]	2	250 V [DC]	4	400 V [DC]	6	630 V [DC]	10	1000 V [DC]	12	1250 V [DC]	1A	125 V [AC]	2A	250 V [AC]				<table border="1"> <thead> <tr> <th>Code</th> <th>Cap. Tol.</th> </tr> </thead> <tbody> <tr><td>J</td><td>±5 %</td></tr> <tr><td>K</td><td>±10 %</td></tr> </tbody> </table>	Code	Cap. Tol.	J	±5 %	K	±10 %	<table border="1"> <thead> <tr> <th>Code</th> <th>Lead form</th> </tr> </thead> <tbody> <tr><td>Blank</td><td>Straight</td></tr> <tr><td>B</td><td>Crimped lead</td></tr> <tr><td>Z</td><td>Cut lead</td></tr> <tr><td>3</td><td>Crimped taping (Ammo)</td></tr> <tr><td>6</td><td>Crimped taping (Ammo)</td></tr> </tbody> </table>	Code	Lead form	Blank	Straight	B	Crimped lead	Z	Cut lead	3	Crimped taping (Ammo)	6	Crimped taping (Ammo)
Code	R.voltage																																													
1	100 V [DC]																																													
2	250 V [DC]																																													
4	400 V [DC]																																													
6	630 V [DC]																																													
10	1000 V [DC]																																													
12	1250 V [DC]																																													
1A	125 V [AC]																																													
2A	250 V [AC]																																													
Code	Cap. Tol.																																													
J	±5 %																																													
K	±10 %																																													
Code	Lead form																																													
Blank	Straight																																													
B	Crimped lead																																													
Z	Cut lead																																													
3	Crimped taping (Ammo)																																													
6	Crimped taping (Ammo)																																													

- Odd size taping

1	2	3	4	5	6	7	8	9	10	11	12
<b>E</b>	<b>C</b>	<b>Q</b>	<b>E</b>						<b>R</b>		<b>F</b>
Product code		Dielectric & construction		Rated voltage		Capacitance			Odd taping	Cap. Tol.	Suffix

**Specifications**

Category temp. range (Including temperature-rise on unit surface)	100V to 1250V [DC]	-40 °C to +105 °C
	125 V, 250 V [AC]	-40 °C to +105 °C
Rated voltage	100 V, 250 V, 400 V, 630 V, 1000 V, 1250 V [DC] (Derating of rated voltage by 1.25 %/°C at more than 85 °C) 125 V, 250 V [AC]	
Capacitance range	100 V [DC]	0.56 µF to 10.0 µF (E12)
	250 V [DC]	0.010 µF to 10.0 µF (E12)
	400 V [DC]	0.010 µF to 2.2 µF (E12)
	630 V [DC]	0.0010 µF to 2.2 µF (E12)
	1000 V [DC]	0.010 µF to 0.22 µF (E12)
	1250 V [DC]	0.0010 µF to 0.22 µF (E12)
	125 V [AC]	0.010 µF to 0.068 µF (E12)
	250 V [AC]	0.010 µF to 2.2 µF (E12)
Capacitance tolerance	±5 % (J), ±10 % (K)	
Dissipation factor (tan δ)	tan δ ≤ 1.0 % (20 °C, 1 kHz)	
Withstand voltage	100V to 630V [DC]	Between terminals : R.voltage (V [DC]) × 150 %, 60 s
	1000 V [DC]	Between terminals : R.voltage (V) × 175 %, 2 s to 5 s or 1000 V [AC], 60 s
	1250 V [DC]	Between terminals to enclosure : 1500 V [AC], 60 s
	125 V [AC]	Between terminals : R.voltage (V) × 230 %, 60 s
	250 V [AC]	Between terminals to enclosure : 1500 V [AC], 60 s
Insulation resistance (IR)	100V to 630V [DC]	C ≤ 0.33 µF : IR ≥ 9000 MΩ (20 °C, 100 V [DC], 60 s) C > 0.33 µF : IR ≥ 3000 MΩ · µF (20 °C, 100 V [DC], 60 s)
	1000 V [DC]	IR ≥ 10000 MΩ (20 °C, 100 V [DC], 60 s)
	1250 V [DC]	IR ≥ 2000 MΩ (20 °C, 500 V [DC], 60 s)
	125 V [AC]	C ≤ 0.47 µF : IR ≥ 2000 MΩ (20 °C, 500 V [DC], 60 s)
	250 V [AC]	C > 0.47 µF : IR ≥ 3000 MΩ · µF (20 °C, 100 V [DC], 60 s)

- \* In case of applying voltage in alternating current (50 Hz or 60 Hz sine wave) to a capacitor with DC rated voltage, please refer to the page of "Permissible voltage (R.M.S) in alternating current corresponding to DC rated voltage".
- \* Voltage to be applied to ECQE1A (F) & ECQE2A (F) is only sine wave (50 Hz or 60 Hz).

**Dimensions**

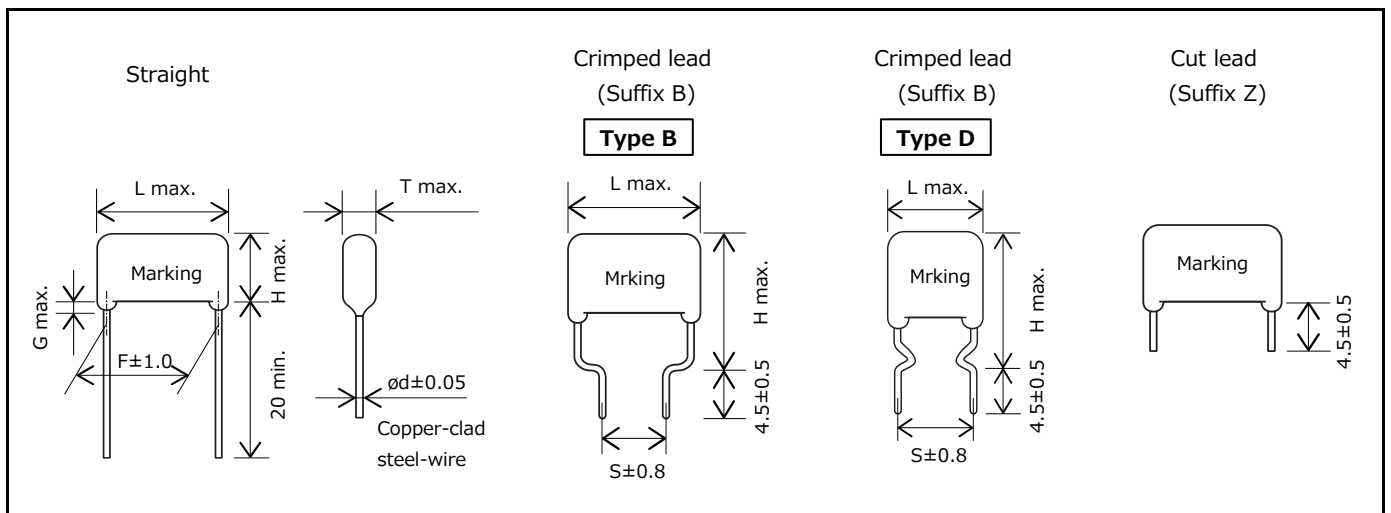

**Packaging specifications for bulk package**

- Packing quantity : 100 pcs./bag

**Taping specifications for automatic insertion**

■ Taping style

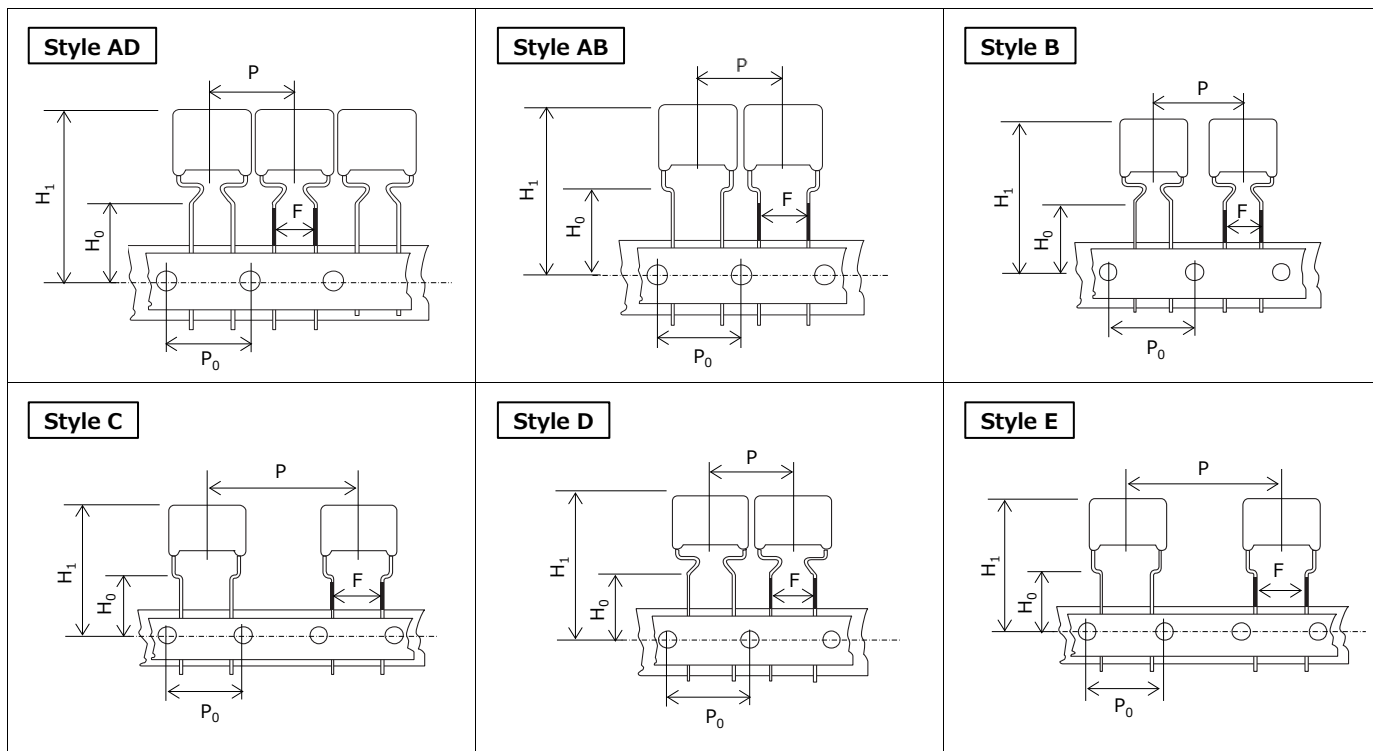

\*: H1 dimension is based on insertion machine "Panaset RH series" made by Panasonic. Consult with Panasonic technical staff when using other insertion machines.

**Size list**

Unit : mm

	Style					
	AD	AB	B	C	D	E
P	12.7	12.7	15.0	25.4	15.0	30.0
P <sub>0</sub>	12.7	12.7	15.0	12.7	15.0	15.0
F	5.0	5.0	5.0	5.0	7.5	7.5
H <sub>0</sub>	16.0	16.0	16.0	16.0	16.0	16.0
H <sub>1</sub> *	34.0	34.0	39.0	39.0	44.0	44.0

\*:max.

■ Packaging specifications

Series	R.voltage	Capacitance range (μF)	Taping style						Packing	Suffix
			AD	AB	B	C	D	E		
ECQE(F)	100 V [DC]	0.56 to 0.68	○						Ammo	( ) F3
		0.82 to 1.0			○				Ammo	( ) F3
		1.2 to 3.3				○			Ammo	( ) F3
		1.2 to 3.3						○	Ammo	R( ) F
	250 V [DC]	0.010 to 0.27	○						Ammo	( ) F3
		0.33			○				Ammo	( ) F3
		0.39 to 1.5				○			Ammo	( ) F3
		0.010 to 0.33						○	Ammo	R( ) F
	400 V [DC]	0.39 to 1.5						○	Ammo	R( ) F
		0.010 to 0.10	○						Ammo	( ) F3
		0.12 to 0.47				○			Ammo	( ) F3
		0.010 to 0.10						○	Ammo	R( ) F
	630 V [DC]	0.12 to 0.47						○	Ammo	R( ) F
		0.0010 to 0.033	○						Ammo	( ) F3
		0.039 to 0.047			○				Ammo	( ) F3
		0.056 to 0.22				○			Ammo	( ) F3
	1000 V [DC]	0.001 to 0.047						○	Ammo	R( ) F
	1250 V [DC]	0.010 to 0.10						○	Ammo	R( ) F
	125 V [AC]	0.0010 to 0.022						○	Ammo	R( ) F
		0.010 to 0.068		○					Ammo	( ) F6
250 V [AC]	0.010 to 0.068						○	Ammo	R( ) F	
	0.010 to 0.033		○					Ammo	( ) F6	
	0.010 to 0.047						○	Ammo	R( ) F	
	0.056 to 0.22						○	Ammo	R( ) F	

● Lead spacing

Style	Lead spacing
AD	5.0
AB	5.0
B	5.0
C	5.0
D	7.5
E	7.5

Unit : mm

See the column "Rating · Dimensions · Quantity" for packaging quantity

Design and specifications are each subject to change without notice. Ask factory for the current technical specifications before purchase and/or use.

Should a safety concern arise regarding this product, please be su

Rating · Dimensions · Quantity

■ Rated voltage [DC] : 100 V, Capacitance tolerance : ±5 %(J), ±10 %(K)

Part No.	Cap. (µF)	Dimensions (mm)								Min. order Q'ty (PCS)			
		L max.	T max.	H max.		F	S	G	ød	Taping			Bulk Straight-Crimped lead
				Straight	Crimped lead					Standard 5.0 mm	Odd size 5.0 mm	Odd size 7.5 mm	
ECQE1564□F( )	0.56	12.0	5.5	10.9	15.9	10.0	10.0	1.0	0.6	500	-	-	500
ECQE1684□F( )	0.68	12.0	6.0	11.9	16.9	10.0	10.0	1.0	0.6				
ECQE1824□F( )	0.82	12.0	6.0	13.5	18.5	10.0	10.0	1.0	0.6				
ECQE1105□F( )	1.0	12.0	6.7	14.0	19.0	10.0	10.0	1.0	0.6				
ECQE1125□F( )	1.2	18.5	5.5	12.8	17.8	15.0	10.0	1.0	0.6				
ECQE1155□F( )	1.5	18.5	6.0	13.4	18.4	15.0	10.0	1.0	0.8				
ECQE1185□F( )	1.8	18.5	6.5	14.4	19.4	15.0	10.0	1.0	0.8				
ECQE1225□F( )	2.2	18.5	7.0	15.0	20.0	15.0	10.0	1.0	0.8				
ECQE1275□F( )	2.7	18.5	8.0	15.8	20.8	15.0	10.0	1.0	0.8				
ECQE1335□F( )	3.3	18.5	8.5	16.5	21.5	15.0	10.0	1.0	0.8				
ECQE1395□F( )	3.9	26.0	7.0	16.4	21.4	22.5	15.0	1.0	0.8				
ECQE1475□F( )	4.7	26.0	7.5	17.0	22.0	22.5	15.0	1.0	0.8				
ECQE1565□F( )	5.6	26.0	8.3	17.5	22.5	22.5	15.0	1.0	0.8				
ECQE1685□F( )	6.8	26.0	9.0	18.5	23.5	22.5	15.0	1.0	0.8				
ECQE1825□F( )	8.2	26.0	10.0	20.0	25.0	22.5	15.0	1.5	0.8				
ECQE1106□F( )	10.0	26.0	11.5	21.0	26.0	22.5	15.0	1.5	0.8				

\* □ : Capacitance tolerance code

( ) : Suffix for lead crimped or taped type

Type D : 0.56 µF to 1.0 µF

Type B : 1.2 µF to 10.0 µF

■ Rated voltage [DC] : 250 V, Capacitance tolerance : ±5 %(J), ±10 %(K)

Part No.	Cap. (µF)	Dimensions (mm)								Min. order Q'ty (PCS)				
		L max.	T max.	H max.		F	S	G	ød	Taping			Bulk	
				Straight	Crimped lead					Standard 5.0 mm	Odd size 5.0 mm	Odd size 7.5 mm	Straight	Crimped lead
ECQE2103□F( )	0.010	10.3	4.3	7.4	12.4	7.5	7.5	1.0	0.6	1000	-	1000	500	500
ECQE2123□F( )	0.012	10.3	4.4	7.5	12.5	7.5	7.5	1.0	0.6					
ECQE2153□F( )	0.015	10.3	4.4	7.5	12.5	7.5	7.5	1.0	0.6					
ECQE2183□F( )	0.018	10.3	4.4	7.5	12.5	7.5	7.5	1.0	0.6					
ECQE2223□F( )	0.022	10.3	4.4	7.5	12.5	7.5	7.5	1.0	0.6					
ECQE2273□F( )	0.027	10.3	4.4	7.5	12.5	7.5	7.5	1.0	0.6					
ECQE2333□F( )	0.033	10.3	4.5	7.5	12.5	7.5	7.5	1.0	0.6					
ECQE2393□F( )	0.039	10.3	4.5	7.5	12.5	7.5	7.5	1.0	0.6					
ECQE2473□F( )	0.047	10.3	4.5	7.5	12.5	7.5	7.5	1.0	0.6					
ECQE2563□F( )	0.056	10.3	4.8	7.9	12.9	7.5	7.5	1.0	0.6					
ECQE2683□F( )	0.068	10.3	4.5	7.5	12.5	7.5	7.5	1.0	0.6					
ECQE2823□F( )	0.082	10.3	4.9	8.0	13.0	7.5	7.5	1.0	0.6					
ECQE2104□F( )	0.10	10.3	5.8	8.4	13.4	7.5	7.5	1.0	0.6					
ECQE2124□F( )	0.12	10.3	6.0	9.0	14.0	7.5	7.5	1.0	0.6					
ECQE2154□F( )	0.15	10.3	6.0	10.8	15.8	7.5	7.5	1.0	0.6					
ECQE2184□F( )	0.18	12.0	5.0	10.3	15.3	10.0	10.0	1.0	0.6					
ECQE2224□F( )	0.22	12.0	5.5	10.5	15.5	10.0	10.0	1.0	0.6					
ECQE2274□F( )	0.27	12.0	6.0	11.5	16.5	10.0	10.0	1.0	0.6					
ECQE2334□F( )	0.33	12.0	6.5	12.0	17.0	10.0	10.0	1.0	0.6					
ECQE2394□F( )	0.39	18.5	4.9	12.0	17.0	15.0	10.0	1.0	0.6					
ECQE2474□F( )	0.47	18.5	5.3	12.5	17.5	15.0	10.0	1.0	0.6					
ECQE2564□F( )	0.56	18.5	5.5	13.0	18.0	15.0	10.0	1.0	0.6					
ECQE2684□F( )	0.68	18.5	6.0	13.5	18.5	15.0	10.0	1.0	0.8					
ECQE2824□F( )	0.82	18.5	6.5	14.5	19.5	15.0	10.0	1.0	0.8					
ECQE2105□F( )	1.0	18.5	7.4	15.0	20.0	15.0	10.0	1.0	0.8					
ECQE2125□F( )	1.2	18.5	8.0	15.9	20.9	15.0	10.0	1.0	0.8					
ECQE2155□F( )	1.5	18.5	9.0	16.8	21.8	15.0	10.0	1.0	0.8					
ECQE2185□F( )	1.8	26.0	7.5	15.5	20.5	22.5	15.0	1.0	0.8					
ECQE2225□F( )	2.2	26.0	8.5	16.3	21.3	22.5	15.0	1.0	0.8					
ECQE2275□F( )	2.7	26.0	9.4	17.0	22.0	22.5	15.0	1.0	0.8					
ECQE2335□F( )	3.3	26.0	10.3	18.0	23.0	22.5	15.0	1.5	0.8					
ECQE2395□F( )	3.9	26.0	11.0	20.5	25.5	22.5	15.0	1.5	0.8					
ECQE2475□F( )	4.7	26.0	12.0	21.5	26.5	22.5	15.0	1.5	0.8					
ECQE2565□F( )	5.6	31.0	11.8	21.0	26.0	27.5	22.5	1.5	0.8					
ECQE2685□F( )	6.8	31.0	13.0	22.4	27.4	27.5	22.5	1.5	0.8					
ECQE2825□F( )	8.2	31.0	14.3	23.5	28.5	27.5	22.5	1.5	0.8					
ECQE2106□F( )	10.0	31.0	15.9	25.8	30.8	27.5	22.5	1.5	0.8					

\* □ : Capacitance tolerance code

( ) : Suffix for lead crimped or taped type

Type D : 0.010 µF to 0.33 µF

Type B : 0.39 µF to 10.0 µF

## Rating · Dimensions · Quantity

■ Rated voltage [DC] : 400 V, Capacitance tolerance :  $\pm 5\%$ (J),  $\pm 10\%$ (K)

Part No.	Cap. ( $\mu$ F)	Dimensions (mm)								Min. order Q'ty (PCS)			
		L max.	T max.	H max.		F	S	G	$\phi$ d	Taping			Bulk Straight- Crimped lead
				Straight	Crimped lead					Standard 5.0 mm	Odd size 5.0 mm	Odd size 7.5 mm	
ECQE4103□F( )	0.010	10.3	4.3	7.4	12.4	7.5	7.5	1.0	0.6	1000	-	1000	500
ECQE4123□F( )	0.012	10.3	4.4	7.5	12.5	7.5	7.5	1.0	0.6				
ECQE4153□F( )	0.015	10.3	4.4	7.5	12.5	7.5	7.5	1.0	0.6				
ECQE4183□F( )	0.018	10.3	4.4	7.5	12.5	7.5	7.5	1.0	0.6				
ECQE4223□F( )	0.022	10.3	4.8	7.9	12.9	7.5	7.5	1.0	0.6				
ECQE4273□F( )	0.027	10.3	5.5	8.0	13.0	7.5	7.5	1.0	0.6				
ECQE4333□F( )	0.033	10.3	6.0	9.0	14.0	7.5	7.5	1.0	0.6	500	-	1000	
ECQE4393□F( )	0.039	12.0	4.9	8.0	13.0	10.0	10.0	1.0	0.6				
ECQE4473□F( )	0.047	12.0	5.0	8.3	13.3	10.0	10.0	1.0	0.6				
ECQE4563□F( )	0.056	12.0	5.0	10.0	15.0	10.0	10.0	1.0	0.6				
ECQE4683□F( )	0.068	12.0	5.4	10.5	15.5	10.0	10.0	1.0	0.6				
ECQE4823□F( )	0.082	12.0	5.8	11.0	16.0	10.0	10.0	1.0	0.6				
ECQE4104□F( )	0.10	12.0	6.3	12.0	17.0	10.0	10.0	1.0	0.6	500	-	500	
ECQE4124□F( )	0.12	18.5	5.0	10.0	15.0	15.0	10.0	1.0	0.6				
ECQE4154□F( )	0.15	18.5	5.0	12.4	17.4	15.0	10.0	1.0	0.6				
ECQE4184□F( )	0.18	18.5	5.4	12.5	17.5	15.0	10.0	1.0	0.6				
ECQE4224□F( )	0.22	18.5	5.9	13.0	18.0	15.0	10.0	1.0	0.6				
ECQE4274□F( )	0.27	18.5	6.5	14.3	19.3	15.0	10.0	1.0	0.8				
ECQE4334□F( )	0.33	18.5	7.0	14.9	19.9	15.0	10.0	1.0	0.8				
ECQE4394□F( )	0.39	18.5	7.5	15.4	20.4	15.0	10.0	1.0	0.8				
ECQE4474□F( )	0.47	18.5	7.8	17.0	22.0	15.0	10.0	1.0	0.8				
ECQE4564□F( )	0.56	26.0	6.5	16.0	21.0	22.5	15.0	1.0	0.8				
ECQE4684□F( )	0.68	26.0	7.0	16.5	21.5	22.5	15.0	1.0	0.8				
ECQE4824□F( )	0.82	26.0	7.9	17.3	22.3	22.5	15.0	1.0	0.8				
ECQE4105□F( )	1.0	26.0	8.5	18.0	23.0	22.5	15.0	1.0	0.8	-	-	-	
ECQE4125□F( )	1.2	26.0	9.5	18.9	23.9	22.5	15.0	1.0	0.8				
ECQE4155□F( )	1.5	31.0	9.5	19.0	24.0	27.5	22.5	1.0	0.8				
ECQE4185□F( )	1.8	31.0	11.0	20.5	25.5	27.5	22.5	1.5	0.8				
ECQE4225□F( )	2.2	31.0	11.0	22.0	27.0	27.5	22.5	1.5	0.8				

\* □ : Capacitance tolerance code

( ) : Suffix for lead crimped or taped type

Type D : 0.010  $\mu$ F to 0.10  $\mu$ F

Type B : 0.12  $\mu$ F to 2.2  $\mu$ F

**Rating · Dimensions · Quantity**

■ Rated voltage [DC] : 630 V, Capacitance tolerance : ±5 %(J), ±10 %(K)

Part No.	Cap. (µF)	Dimensions (mm)								Min. order Q'ty (PCS)				
		L max.	T max.	H max.		F	S	G	ød	Taping			Bulk	
				Straight	Crimped lead					Straight	Crimped lead	Straight	Crimped lead	
ECQE6102□F( )	0.0010	10.0	4.5	9.5	14.5	7.5	5.0	1.0	0.6	1000	-	1000	500	500
ECQE6122□F( )	0.0012	10.0	4.5	10.0	15.0	7.5	5.0	1.0	0.6					
ECQE6152□F( )	0.0015	10.0	4.5	10.0	15.0	7.5	5.0	1.0	0.6					
ECQE6182□F( )	0.0018	10.0	4.5	10.0	15.0	7.5	5.0	1.0	0.6					
ECQE6222□F( )	0.0022	10.0	4.5	10.0	15.0	7.5	5.0	1.0	0.6					
ECQE6272□F( )	0.0027	10.0	4.5	10.0	15.0	7.5	5.0	1.0	0.6					
ECQE6332□F( )	0.0033	10.0	4.5	10.0	15.0	7.5	5.0	1.0	0.6					
ECQE6392□F( )	0.0039	10.0	4.5	10.0	15.0	7.5	5.0	1.0	0.6					
ECQE6472□F( )	0.0047	12.0	4.5	10.0	15.0	10.0	7.5	1.0	0.6					
ECQE6562□F( )	0.0056	12.0	4.5	10.0	15.0	10.0	7.5	1.0	0.6					
ECQE6682□F( )	0.0068	12.0	4.9	10.0	15.0	10.0	7.5	1.0	0.6					
ECQE6822□F( )	0.0082	12.0	4.5	10.0	15.0	10.0	7.5	1.0	0.6					
ECQE6103□F( )	0.010	12.0	4.5	7.5	12.5	10.0	10.0	1.0	0.6					
ECQE6123□F( )	0.012	12.0	4.5	7.8	12.8	10.0	10.0	1.0	0.6					
ECQE6153□F( )	0.015	12.0	5.0	8.2	13.2	10.0	10.0	1.0	0.6					
ECQE6183□F( )	0.018	12.0	4.9	10.0	15.0	10.0	10.0	1.0	0.6					
ECQE6223□F( )	0.022	12.0	5.3	10.5	15.5	10.0	10.0	1.0	0.6					
ECQE6273□F( )	0.027	12.0	5.5	10.9	15.9	10.0	10.0	1.0	0.6					
ECQE6333□F( )	0.033	12.0	6.0	11.9	16.9	10.0	10.0	1.0	0.6					
ECQE6393□F( )	0.039	12.0	6.0	13.4	18.4	10.0	10.0	1.0	0.6					
ECQE6473□F( )	0.047	12.0	6.5	13.5	18.5	10.0	10.0	1.0	0.6					
ECQE6563□F( )	0.056	18.5	5.4	10.5	15.5	15.0	10.0	1.0	0.6					
ECQE6683□F( )	0.068	18.5	5.8	11.0	16.0	15.0	10.0	1.0	0.6					
ECQE6823□F( )	0.082	18.5	6.5	12.0	17.0	15.0	10.0	1.0	0.6					
ECQE6104□F( )	0.10	18.5	6.3	14.0	19.0	15.0	10.0	1.0	0.6					
ECQE6124□F( )	0.12	18.5	6.3	14.5	19.5	15.0	10.0	1.0	0.8					
ECQE6154□F( )	0.15	18.5	7.5	15.4	20.4	15.0	10.0	1.0	0.8					
ECQE6184□F( )	0.18	18.5	8.0	16.0	21.0	15.0	10.0	1.0	0.8					
ECQE6224□F( )	0.22	18.5	9.0	16.5	21.5	15.0	10.0	1.0	0.8					
ECQE6274□F( )	0.27	26.0	7.0	16.5	21.5	22.5	15.0	1.0	0.8					
ECQE6334□F( )	0.33	26.0	7.8	17.0	22.0	22.5	15.0	1.0	0.8					
ECQE6394□F( )	0.39	26.0	8.5	17.9	22.9	22.5	15.0	1.0	0.8					
ECQE6474□F( )	0.47	26.0	9.3	18.5	23.5	22.5	15.0	1.0	0.8					
ECQE6564□F( )	0.56	26.0	10.0	20.0	25.0	22.5	15.0	1.5	0.8					
ECQE6684□F( )	0.68	26.0	11.5	21.0	26.0	22.5	15.0	1.5	0.8					
ECQE6824□F( )	0.82	31.0	11.3	20.5	25.5	27.5	22.5	1.5	0.8					
ECQE6105□F( )	1.0	31.0	12.5	21.9	26.9	27.5	22.5	1.5	0.8					
ECQE6125□F( )	1.2	31.0	13.5	23.0	28.0	27.5	22.5	1.5	0.8					
ECQE6155□F( )	1.5	31.0	15.3	24.7	29.7	27.5	22.5	1.5	0.8					
ECQE6185□F( )	1.8	31.0	16.8	27.0	32.0	27.5	22.5	1.5	0.8					
ECQE6225□F( )	2.2	31.0	19.5	29.0	34.0	27.5	22.5	1.5	0.8					

\* □ : Capacitance tolerance code  
 ( ) : Suffix for lead crimped or taped type

Type D : 0.010 µF to 0.047 µF  
 Type B : 0.0010 µF to 0.0082 µF, 0.056 µF to 2.2 µF

## Rating · Dimensions · Quantity

■ Rated voltage [DC] : 1000 V, 125 V [AC]\*1, Capacitance tolerance : ±5 %(J), ±10 %(K)

Part No.	Cap. ( $\mu$ F)	Dimensions (mm)								Min. order Q'ty (PCS)	
		L max.	T max.	H max.		F	S	G max. Straight	$\phi$ d	Taping	Bulk
				Straight	Crimped lead					Straight	Crimped lead
ECQE10103□F( )	0.010	15.5	6.0	11.0	16.0	12.5	12.5	1.0	0.6	500	500
ECQE10123□F( )	0.012	15.5	6.0	12.0	17.0	12.5	12.5	1.0	0.6		
ECQE10153□F( )	0.015	15.5	7.0	12.5	17.5	12.5	12.5	1.0	0.6		
ECQE10183□F( )	0.018	15.5	7.5	13.0	20.0	12.5	12.5	1.0	0.8	400	
ECQE10223□F( )	0.022	15.5	7.5	15.5	22.5	12.5	12.5	1.0	0.8		
ECQE10273□F( )	0.027	21.0	6.0	13.0	18.0	17.5	12.5	1.0	0.8	500	
ECQE10333□F( )	0.033	21.0	6.5	14.0	19.0	17.5	12.5	1.0	0.8		
ECQE10393□F( )	0.039	21.0	7.0	14.5	19.5	17.5	12.5	1.0	0.8		
ECQE10473□F( )	0.047	21.0	7.5	15.5	20.5	17.5	12.5	1.0	0.8	400	
ECQE10563□F( )	0.056	21.0	7.5	17.0	22.0	17.5	12.5	1.0	0.8		
ECQE10683□F( )	0.068	21.0	8.5	18.0	23.0	17.5	12.5	1.0	0.8	300	
ECQE10823□F( )	0.082	21.0	9.0	18.5	23.5	17.5	12.5	1.0	0.8		
ECQE10104□F( )	0.10	21.0	10.0	20.0	25.0	17.5	12.5	1.0	0.8		
ECQE10124□F( )	0.12	26.0	9.0	18.5	23.5	22.5	17.5	1.0	0.8	-	
ECQE10154□F( )	0.15	26.0	10.0	20.0	25.0	22.5	17.5	1.5	0.8		
ECQE10184□F( )	0.18	26.0	10.5	22.0	27.0	22.5	17.5	1.5	0.8		
ECQE10224□F( )	0.22	26.0	12.0	23.0	28.0	22.5	17.5	1.5	0.8		

\* □ : Capacitance tolerance code

( ) : Suffix for lead crimped or taped type

Type D : 0.010  $\mu$ F to 0.022  $\mu$ F

Type B : 0.027  $\mu$ F to 0.22  $\mu$ F

\*1 : This type has two rated voltage, one is DC rated voltage another is AC rated voltage.

DC rated voltage is 1000 V [DC], AC rated voltage is 125 V [AC].

Making for rated voltage is "1000 V, 125 V $\sim$ "

When capacitors use in secondary side of power source, and in case of applying voltage in altering current (50 Hz or 60 Hz sine wave) to a capacitor, please refer to the page of "Permissible voltage (R.M.S) in altering current corresponding to DC rated voltage".

When capacitors use in primary side of power source, the rated voltage is shown 125 V [AC]. Voltage to be applied to capacitors in only sine wave (50 Hz or 60 Hz).

AC rated capacitors complying with clause 1 of "Electrical Appliance and Material Safety Law". And not complying with clause 2 of "Electrical Appliance and Material Safety Law", in this case please use ECQUA type or ECQUL type.

## Rating · Dimensions · Quantity

■ Rated voltage [DC] : 1250 V, 125 V [AC]\*1, Capacitance tolerance : ±5 %(J), ±10 %(K)

Part No.	Cap. ( $\mu$ F)	寸法 (mm)								Min. order Q'ty (PCS)				
		L max.	T max.	H max.		F		S		G max. Straight	$\phi$ d	Taping	Bulk	
				Straight	Crimped lead	Straight	Crimped lead	Straight	Crimped lead			Odd size 7.5 mm	Straight	Crimped lead
ECQE12102□F( )	0.0010	15.5	6.0	11.0	16.0	12.5	10.0	1.0	0.6	500				
ECQE12122□F( )	0.0012	15.5	6.0	11.0	16.0	12.5	10.0	1.0	0.6					
ECQE12152□F( )	0.0015	15.5	6.0	11.0	16.0	12.5	10.0	1.0	0.6					
ECQE12182□F( )	0.0018	15.5	6.0	11.0	16.0	12.5	10.0	1.0	0.6					
ECQE12222□F( )	0.0022	15.5	6.0	11.5	16.5	12.5	10.0	1.0	0.6					
ECQE12272□F( )	0.0027	15.5	6.5	12.0	17.0	12.5	10.0	1.0	0.6					
ECQE12332□F( )	0.0033	15.5	6.0	11.5	16.5	12.5	10.0	1.0	0.6					
ECQE12392□F( )	0.0039	15.5	6.5	12.0	17.0	12.5	10.0	1.0	0.6					
ECQE12472□F( )	0.0047	15.5	7.0	12.5	17.5	12.5	10.0	1.0	0.6					
ECQE12562□F( )	0.0056	15.5	7.5	13.0	18.0	12.5	10.0	1.0	0.6					
ECQE12682□F( )	0.0068	15.5	7.5	15.0	20.0	12.5	10.0	1.0	0.6	400				
ECQE12822□F( )	0.0082	21.0	5.0	12.0	17.0	17.5	12.5	1.0	0.6					
ECQE12103□F( )	0.010	21.0	5.0	12.5	17.5	17.5	12.5	1.0	0.6	500	500	500		
ECQE12123□F( )	0.012	21.0	5.5	13.0	18.0	17.5	12.5	1.0	0.6					
ECQE12153□F( )	0.015	21.0	6.0	13.5	18.5	17.5	12.5	1.0	0.6					
ECQE12183□F( )	0.018	21.0	6.5	14.5	19.5	17.5	12.5	1.0	0.8					
ECQE12223□F( )	0.022	21.0	7.0	15.0	20.0	17.5	12.5	1.0	0.8					
ECQE12273□F( )	0.027	26.0	6.0	15.5	20.5	22.5	17.5	1.0	0.8	-				
ECQE12333□F( )	0.033	26.0	6.5	16.0	21.0	22.5	17.5	1.0	0.8					
ECQE12393□F( )	0.039	26.0	7.0	16.5	21.5	22.5	17.5	1.0	0.8					
ECQE12473□F( )	0.047	26.0	8.0	17.0	22.0	22.5	17.5	1.0	0.8					
ECQE12563□F( )	0.056	31.0	7.5	17.0	22.0	27.5	22.5	1.0	0.8					
ECQE12683□F( )	0.068	31.0	8.0	17.5	22.5	27.5	22.5	1.0	0.8					
ECQE12823□F( )	0.082	31.0	9.0	18.5	23.5	27.5	22.5	1.0	0.8					
ECQE12104□F( )	0.10	31.0	10.0	19.5	24.5	27.5	22.5	1.0	0.8					
ECQE12124□F( )	0.12	31.0	11.5	20.5	25.5	27.5	22.5	1.5	0.8					
ECQE12154□F( )	0.15	31.0	12.0	23.0	28.0	27.5	22.5	1.5	0.8					
ECQE12184□F( )	0.18	31.0	13.0	24.5	29.5	27.5	22.5	1.5	0.8					
ECQE12224□F( )	0.22	31.0	14.5	26.5	31.5	27.5	22.5	1.5	0.8				400	

\* □ : Capacitance tolerance code

( ) : Suffix for lead crimped or taped type

Type D : 0.0010  $\mu$ F to 0.0068  $\mu$ F

Type B : 0.0082  $\mu$ F to 0.22  $\mu$ F

\*1 : This type has two rated voltage, one is DC rated voltage another is AC rated voltage.

DC rated voltage is 1250 V [DC], AC rated voltage is 125 V [AC].

Making for rated voltage is "1250 V, 125 V $\sim$ "

When capacitors use in secondary side of power source, and in case of applying voltage in altering current (50 Hz or 60 Hz sine wave) to a capacitor, please refer to the page of "Permissible voltage (R.M.S) in altering current corresponding to DC rated voltage".

When capacitors use in primary side of power source, the rated voltage is shown 125 V [AC]. Voltage to be applied to capacitors in only sine wave (50 Hz or 60 Hz).

AC rated capacitors complying with clause 1 of "Electrical Appliance and Material Safety Law". And not complying with clause 2 of "Electrical Appliance and Material Safety Law", in this case please use ECQUA type or ECQUL type.



**Rating · Dimensions · Quantity**

- Rated voltage [AC] : 125 V, Capacitance tolerance : ±5 %(J), ±10 %(K)  
Noise suppression Capacitors (Across-the-line)

Part No.	Cap. (µF)	Dimensions (mm)								Min. order Q'ty (PCS)					
		L max.	T max.	H max.		F		S		G	ød	Taping			Bulk Straight · Crimped lead
				Straight	Crimped lead	Straight	Crimped lead	Straight	Crimped lead			Standard 5.0 mm	Odd size 5.0 mm	Odd size 7.5 mm	
ECQE1A103□F( )	0.010	10.5	4.5	7.5	12.5	7.5	7.5	1.0	0.6	1000	-	1000	500		
ECQE1A123□F( )	0.012	10.5	4.4	7.5	12.5	7.5	7.5	1.0	0.6						
ECQE1A153□F( )	0.015	10.5	4.4	7.5	12.5	7.5	7.5	1.0	0.6						
ECQE1A183□F( )	0.018	10.5	4.4	7.5	12.5	7.5	7.5	1.0	0.6						
ECQE1A223□F( )	0.022	10.5	4.4	7.5	12.5	7.5	7.5	1.0	0.6						
ECQE1A273□F( )	0.027	10.5	4.4	7.5	12.5	7.5	7.5	1.0	0.6						
ECQE1A333□F( )	0.033	10.5	4.5	7.8	12.8	7.5	7.5	1.0	0.6						
ECQE1A393□F( )	0.039	10.5	4.5	7.8	12.8	7.5	7.5	1.0	0.6						
ECQE1A473□F( )	0.047	10.5	5.5	8.0	13.0	7.5	7.5	1.0	0.6	500					
ECQE1A563□F( )	0.056	10.5	5.9	8.5	13.5	7.5	7.5	1.0	0.6						
ECQE1A683□F( )	0.068	10.5	6.3	9.4	14.4	7.5	7.5	1.0	0.6						

\* □ : Capacitance tolerance code  
( ) : Suffix for lead crimped or taped type  
Type D : 0.010 µF to 0.068 µF

Notice for AC rated

AC rated capacitors complying with clause 1 of "Electrical Appliance and Material Safety Law".  
As for clause 2 of "Electrical Appliance and Material Safety Law", please use ECQUA type or ECQUL type.

When using these capacitors as a across-the-line capacitor, it shall be required to follow either item 1. or item 2. condition.

1. Capacitor shall be connected in parallel with varistor (Specified varistor voltage in table 1.)
2. Voltage applied for capacitor shall not exceed other than specified in table 1, when using these capacitors

Table 1

Capacitor rated voltage	Varistor voltage	Pulse voltage
125 V [AC]	250 V	250 V <sub>0-p</sub>

## Rating · Dimensions · Quantity

- Rated voltage [AC] : 250 V, Capacitance tolerance :  $\pm 5\%$ (J),  $\pm 10\%$ (K)  
Noise suppression Capacitors (Across-the-line)

Part No.	Cap. ( $\mu\text{F}$ )	Dimensions (mm)								Min. order Q'ty (PCS)			
		L max.	T max.	H max.		F	S	G	$\phi d$	Taping			Bulk Straight · Crimped lead
				Straight	Crimped lead					Standard 5.0 mm	Odd size 5.0 mm	Odd size 7.5 mm	
ECQE2A103□F( )	0.010	12.5	5.5	10.8	15.8	10.0	10.0	1.0	0.6	500	1000	500	500
ECQE2A123□F( )	0.012	12.5	6.0	11.5	16.5	10.0	10.0	1.0	0.6				
ECQE2A153□F( )	0.015	12.5	6.3	9.9	14.9	10.0	10.0	1.0	0.6				
ECQE2A183□F( )	0.018	12.5	6.0	11.9	16.9	10.0	10.0	1.0	0.6				
ECQE2A223□F( )	0.022	12.5	6.0	11.5	16.5	10.0	10.0	1.0	0.6				
ECQE2A273□F( )	0.027	12.5	5.5	10.9	15.9	10.0	10.0	1.0	0.6				
ECQE2A333□F( )	0.033	12.5	6.0	11.9	16.9	10.0	10.0	1.0	0.6				
ECQE2A393□F( )	0.039	12.5	6.0	13.4	18.4	10.0	10.0	1.0	0.6	-	500	500	500
ECQE2A473□F( )	0.047	12.5	6.5	14.4	19.4	10.0	10.0	1.0	0.6				
ECQE2A563□F( )	0.056	18.5	5.4	10.5	15.5	15.0	10.0	1.0	0.6				
ECQE2A683□F( )	0.068	18.5	5.8	11.0	16.0	15.0	10.0	1.0	0.6				
ECQE2A823□F( )	0.082	18.5	6.3	12.0	17.0	15.0	10.0	1.0	0.6				
ECQE2A104□F( )	0.10	18.5	6.3	14.0	19.0	15.0	10.0	1.0	0.6				
ECQE2A124□F( )	0.12	18.5	6.8	14.5	19.5	15.0	10.0	1.0	0.8				
ECQE2A154□F( )	0.15	18.5	7.5	15.4	20.4	15.0	10.0	1.0	0.8				
ECQE2A184□F( )	0.18	18.5	8.0	16.0	21.0	15.0	10.0	1.0	0.8				
ECQE2A224□F( )	0.22	18.5	9.0	16.9	21.9	15.0	10.0	1.0	0.8				
ECQE2A274□F( )	0.27	26.0	7.0	16.5	21.5	22.5	15.0	1.0	0.8	-	-	-	-
ECQE2A334□F( )	0.33	26.0	7.8	17.0	22.0	22.5	15.0	1.0	0.8				
ECQE2A394□F( )	0.39	26.0	8.5	17.9	22.9	22.5	15.0	1.0	0.8				
ECQE2A474□F( )	0.47	26.0	9.3	18.5	23.5	22.5	15.0	1.0	0.8				
ECQE2A564P( )( )	0.56	26.0	10.0	20.0	-	22.5	-	1.0	0.8				
ECQE2A684P( )( )	0.68	26.0	11.5	21.0	-	22.5	-	1.0	0.8				
ECQE2A824P( )( )	0.82	26.0	13.0	22.5	-	22.5	-	1.0	0.8				
ECQE2A105P( )( )	1.0	31.0	12.5	21.9	-	27.5	-	1.5	0.8				
ECQE2A125P( )( )	1.2	31.0	13.5	23.0	-	27.5	-	1.5	0.8				
ECQE2A155P( )( )	1.5	31.0	15.3	24.7	-	27.5	-	1.5	0.8				
ECQE2A185P( )( )	1.8	31.0	16.8	27.0	-	27.5	-	1.5	0.8	-	-	-	-
ECQE2A225P( )( )	2.2	31.0	19.5	29.0	-	27.5	-	1.5	0.8				

\* □ : Capacitance tolerance code

( ) : Suffix for lead crimped or taped type

P( ) : Please contact us about special part number.

\* Please consult us about Crimped lead type of 0.56  $\mu\text{F}$  to 2.2  $\mu\text{F}$ .

Type D : 0.010  $\mu\text{F}$  ~ 0.047  $\mu\text{F}$

Type B : 0.056  $\mu\text{F}$  ~ 0.47  $\mu\text{F}$

## Notice for AC rated

AC rated capacitors complying with clause 1 of "Electrical Appliance and Material Safety Law".

As for clause 2 of "Electrical Appliance and Material Safety Law", please use ECQUA type or ECQUL type.

When using these capacitors as a across-the-line capacitor, it shall be required to follow either item 1. or item 2. condition.

1. Capacitor shall be connected in parallel with varistor (Specified varistor voltage in table 1.)
2. Voltage applied for capacitor shall not exceed other than specified in table 1, when using these capacitors

Table 1

Capacitor rated voltage	Varistor voltage	Pulse voltage
250 V [AC]	470 V	630 V <sub>0-p</sub>

## Guidelines and precautions regarding the technical information and use of our products described in this online catalog.

- If you want to use our products described in this online catalog for applications requiring special qualities or reliability, or for applications where the failure or malfunction of the products may directly jeopardize human life or potentially cause personal injury (e.g. aircraft and aerospace equipment, traffic and transportation equipment, combustion equipment, medical equipment, accident prevention, anti-crime equipment, and/or safety equipment), it is necessary to verify whether the specifications of our products fit to such applications. Please ensure that you will ask and check with our inquiry desk as to whether the specifications of our products fit to such applications use before you use our products.
- The quality and performance of our products as described in this online catalog only apply to our products when used in isolation. Therefore, please ensure you evaluate and verify our products under the specific circumstances in which our products are assembled in your own products and in which our products will actually be used.
- If you use our products in equipment that requires a high degree of reliability, regardless of the application, it is recommended that you set up protection circuits and redundancy circuits in order to ensure safety of your equipment.
- The products and product specifications described in this online catalog are subject to change for improvement without prior notice. Therefore, please be sure to request and confirm the latest product specifications which explain the specifications of our products in detail, before you finalize the design of your applications, purchase, or use our products.
- The technical information in this online catalog provides examples of our products' typical operations and application circuits. We do not guarantee the non-infringement of third party's intellectual property rights and we do not grant any license, right, or interest in our intellectual property.
- If any of our products, product specifications and/or technical information in this online catalog is to be exported or provided to non-residents, the laws and regulations of the exporting country, especially with regard to security and export control, shall be observed.

## <Regarding the Certificate of Compliance with the EU RoHS Directive/REACH Regulations>

- The switchover date for compliance with the RoHS Directive/REACH Regulations varies depending on the part number or series of our products.
- When you use the inventory of our products for which it is unclear whether those products are compliant with the RoHS Directive/REACH Regulation, please select "Sales Inquiry" in the website inquiry form and contact us.

**We do not take any responsibility for the use of our products outside the scope of the specifications, descriptions, guidelines and precautions described in this online catalog.**

## PRECAUTION AND WARNING

- Please consult us in case that demand the specification of our company without fail and do the confirmation of the use condition and that exceeds the entry value and be indistinct when you use it.
- The film capacitors contain a film based dielectric which may be flammable under certain operating conditions. When in use, they can either emit smoke and/or ignite should the product be defective. It is recommended covering the surrounding resin with flame-resistant materials or case as needed particularly.
- In the event of troubles of other parts on the circuit such as shortening and opening, provide with proper means for preventing excessive voltage, current or temperature exceeding the rating from being applied to the film capacitor.
- Prior to use, please make sure that failure of the film capacitors does not have any negative effects on other surrounding electronic circuit components and devices that would possibly cause damage. Proper safety measures should be taken using fail-safe protective circuit designs to help prevent other devices of becoming unsafe.

Example:

- a. State in which basic performance of automobiles (run, turn and stop)
  - b. False operations
  - c. Smoke emission/ignitions
- The Film Capacitor listed in this catalog(except for automotive series) are designed and manufactured specifically for general electronic devices, including audio-video equipment, home appliance, office equipment and data communication equipment etc.. Accordingly, it is strongly recommended that the user contact us in advance if the parts are to be used for the following devices(items 1 -12), which require having advanced security measures. The capacitor for automotive can be used for automobiles such as xEV.
    - (1) Transport Equipment (motor vehicles, airplanes, trains, ships, traffic signal controllers)
    - (2) Medical Equipment (life-support equipment, pacemakers for the heart, dialysis controllers)
    - (3) Aircraft Equipment, Aerospace Equipment (airplanes, artificial satellites, rockets, etc.)
    - (4) Submarine Equipment (submarine repeating equipment, etc.)
    - (5) Generation Control Equipment (equipment for atomic/hydraulic/heat power plants)
    - (6) Information Processing Equipment (large scale computer system)
    - (7) Electric Heating Appliance, Burning Apparatus
    - (8) Rotary Motion Equipment
    - (9) Security Systems
    - (10) Robots
    - (11) Lighting Equipment
    - (12) And any similar types of equipment
  - If used in a specific appliance that requires an extremely high reliability directly relating with any life-supporting equipment like electronic aviation controllers, automotive driving controllers and engine controllers, please consult us and use within the conditions designated in the specification. However the chip type capacitor should not be used in these appliances.

### Note:

1. Technical information in this catalog is intended to convey examples of typical performances and/or applications, and is not intended to convey patents rights, if any.
2. For the products, which are controlled items subject to the Foreign Exchange and Foreign Trade Control Law, the export permission according to the Law is necessary.
3. Note of ozone depleting substances of class1 (ODS) under the Montreal Protocol is used in manufacturing process of Device Solutions Business Division, Panasonic Corporation.

**⚠ Guidelines and precautions (Common)**

(Target product : ECQE, ECWF, ECWH, ECQU, ECHU, ECWU, ECPU)

**1. Operating voltage**

For the film capacitor varies the maximum applicable voltage depending on the applied voltage waveform, current waveform, frequency, ambient temperature (capacitor surface temperature), capacitance value, etc. Use within the specified values by checking the voltage waveform, current waveform, and frequency applied to both ends of the capacitor prior to use. (In the case of high frequency, the permissible voltage varies with the type of the capacitor. For details please see the relevant specifications.)

**1.1 Rated voltage (Note 1)**

- The rated voltage refers to the maximum voltage that can be applied continuously within the category temperature range. If used beyond the rating, it may induce insulation breakdown of the film and cause short circuit. The product lifetime about the maximum rated condition depends on the kind of the capacitor.
- In a metalized capacitor, which has a self-healing action, short circuit or other failure may not occur immediately after application of a voltage over the rated voltage, but the insulation resistance is lowered, and it may lead to smoke or fire depending on the circuit conditions.
- A noise suppression capacitor ( AC rated voltage) should not be used at high frequency circuit. Smoke and ignition may be caused by conditions for use.
- The rated voltage of the capacitor for electronic appliance is usually indicated in the DC voltage except for special purposes.

**1.2 Derating of rated voltage where operating temperature is high**

In film capacitors, the usable upper limit temperature (the capacitor surface temperature) is determined by the kind of dielectric materials.

When used beyond the rated upper limit temperature (usable upper limit temperature), it is necessary to voltage derate the in certain types (models), while other types (models) cannot be used beyond the rated upper limit temperature. Be sure to confirm the type of capacitors before using, and when using beyond the rated upper limit temperature, be sure to reduce the voltage and make sure the capacitor surface temperature is within the usable upper limit temperature as below. When using at high frequency, however, since the capacitor itself has its own temperature rise, and hence the following derating ratio cannot be applied.

**<Rated upper limit temperature, Upper category temperature, and derating ratio of upper category temperature by types in DC use> (Example)**

Dielectric	Type	Rated upper limit temperature	Upper category temperature	Rated voltage by the temperature beyond Rated upper limit temperature
Polyester(PET)	ECQE(F) ECQE(B) ECQE(T)	85°C	105°C	1.25%/°C
Polypropylene (PP)	ECWF(A) rated voltage DC250V ECWF(L) ECWH(A) ECWH(C)	105°C	105°C	No need derating of rated voltage
	ECWF(A) rated voltage DC450V ECWF(A) rated voltage DC630V ECWH(V)	85°C	105°C	1.25%/°C
	ECWFE rated voltage DC450V			
	ECWFD rated voltage DC630V ECWFE rated voltage DC630V	85°C	105°C	1.0%/°C
	ECWFD rated voltage DC450V	85°C	110°C	0.62%/°C
	ECWFG rated voltage DC630V	85°C	110°C	1.0%/°C
polyethylene naphthalate(PPS)	ECWU(X)	105°C	105°C	No need derating of rated voltage
	ECWU(C)	85°C	125°C	1.25%/°C
	ECWU(V16)	85°C	85°C	No need derating of rated voltage
polyphenylene sulfide(PPS)	ECHU(X) rated voltage DC16V ECHU(X) rated voltage DC50V (capacitance 0.0001μF~0.10μF)	125°C	125°C	No need derating of rated voltage
	ECHU(X) rated voltage DC50V (capacitance 0.12μF~0.22μF)	105°C	125°C	1.25%/°C
	ECHU(C)	105°C	105°C	No need derating of rated voltage
Acrylic resin	ECPU(A)	85°C	85°C	No need derating of rated voltage

- The AC rated voltage items are unnecessary for voltage derating by the temperature.  
 Rated upper limit temperature : The upper limit temperature which can't reduce the voltage and can use continuously. (including own temperature rise)  
 Upper category temperature : The upper limit temperature which can reduce the voltage and use continuously. (including own temperature rise)

● **(Example)** Derating of rated voltage to operating temperature. Rated upper limit temperature 85°C, Upper category temperature 105°C, Derating of rated voltage to which is 1.25 %/°C at more than 85 °C

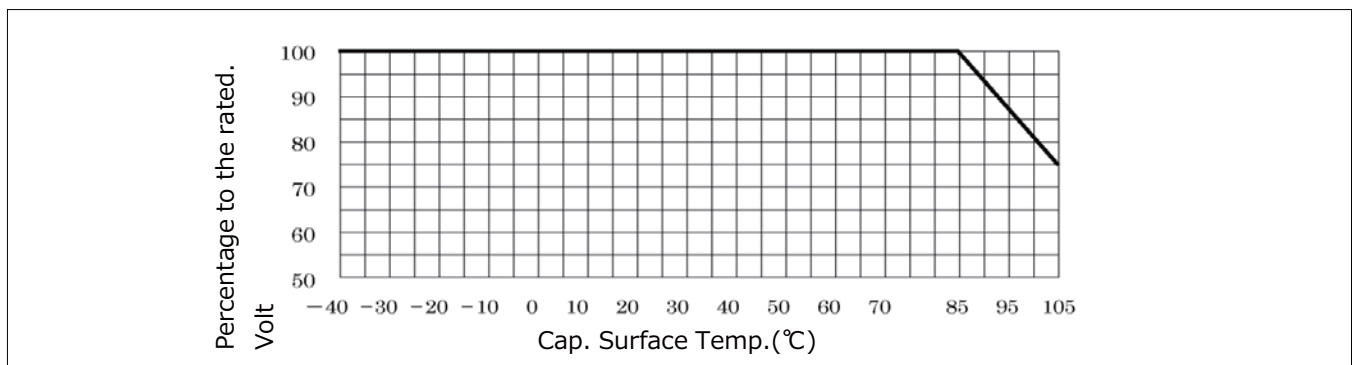

### 1.3 Permissible voltage (R.M.S) in current corresponding to DC Rated Voltage

- A noise suppression capacitor ( AC rated voltage) should be used at the primary side power supplies. The design which premised on use by 50Hz or 60Hz sine wave.
- In case of applying voltage in alternating current (50Hz or 60Hz sine wave) to a capacitor, permissible voltage(R.M.S).The capacitor of DC rating should not be used at the primary side power supplies.

### 1.4 Derating of rated voltage when using at high frequency

When using at high frequency, there is a risk of thermal runaway (smoke, fire) due to self heat generation in the capacitor. Derate the operating voltage according to the example below.

For use at high frequency, we recommend ECHU(X)/(C), ECWF(A)/(L), and ECWH(A)/(C)/(V) types.

#### <Derating example of operating voltage>

Capacitor used : ECWF2154JA (250 VDC, 0.15 μF)

Operating frequency : 40 kHz (sine wave)

Permissible current (entry the value from specification) : 40 kHz, 2.0 Arms

$$V = \frac{I}{2\pi fC} = \frac{2.0}{2 \times 3.14 \times 40 \times 10^3 \times 0.15 \times 10^{-6}} = 53 \text{ Vrms}$$

Therefore, the operating voltage at sine wave 40 kHz is lower than to 53 Vrms (derating ratio 58%), as compared with AC permitted voltage of 125 Vrms at commercial frequency.

(It is necessary to derate until the self heating temperature rise of the capacitor is below the specified value.)

#### Notes

- (1) Use the peak value (Vo-p) of the Pulse voltage applied between the both terminals of the capacitor within the DC rated voltage.
- (2) When using at high frequency, it may lead to breakdown due to withstand voltage deterioration by self heat generation. Therefore, measure the self heating temperature rise value of the capacitor, and make sure it is within the specified.
- (3) Protection for safety should be required in the case of the voltage over the rated voltage (permitted voltage) may be applied to the capacitor due to abnormal action such as trouble elsewhere in the circuit.

## 2. Permitted current

Film capacitors are low in internal impedance, and hence a very large current may flow depending on the circuit. In particular, when turning power switch on and off, make sure a very high pulse current may flow.

When a current exceeding the permissible range flows into capacitor, this can cause the capacitance value to deteriorate or an open circuit condition, temperature rise occurs due to self heat generation, this cause can deterioration of withstand voltage and result in short circuit, possibly leading to smoke or fire.

In the application, make sure current is within permissible current or self heating temperature is within permissible self heating temperature rise limit shown on each delivery specifications.

### 2.1 Permissible current

The permissible current must be considered by dividing into pulse current (peak current) and continuous current (rms current) depending on the breakdown mode, and when using, therefore, make sure the both currents are within the permissible values.

### 2.2 Permissible current to operating frequency

The film capacitor varies in the frequency characteristic of the dissipation factor ( $\tan\delta$ ) depending on the dissipation factor, and hence the permissible rms current for operating frequency differs depending on the capacitor type. In particular, when operating at high frequency, the dissipation factor ( $\tan\delta$ ) increases, and when using over the permissible current, it may include the thermal runaway, possibly leading to smoke or fire. Shown below are typical examples of permissible current by frequency (rms value) of the ECQE(F) type using polyester film and ECWF(A) type using polypropylene film. For detail inquire us by presenting the operating conditions, or make sure the own temperature rise of the capacitor and the capacitor surface temperature are within the permissible range in the worst operating conditions.

2.3 The capacitance and the permissible currents

The permissible rms current varies with the capacitance value. The permissible current (rms) values by the frequencies and by the capacitance of representative types are shown below. In actual use, inquire us for detail by measuring the voltage and current waveforms, ambient temperature, and own temperature rise.

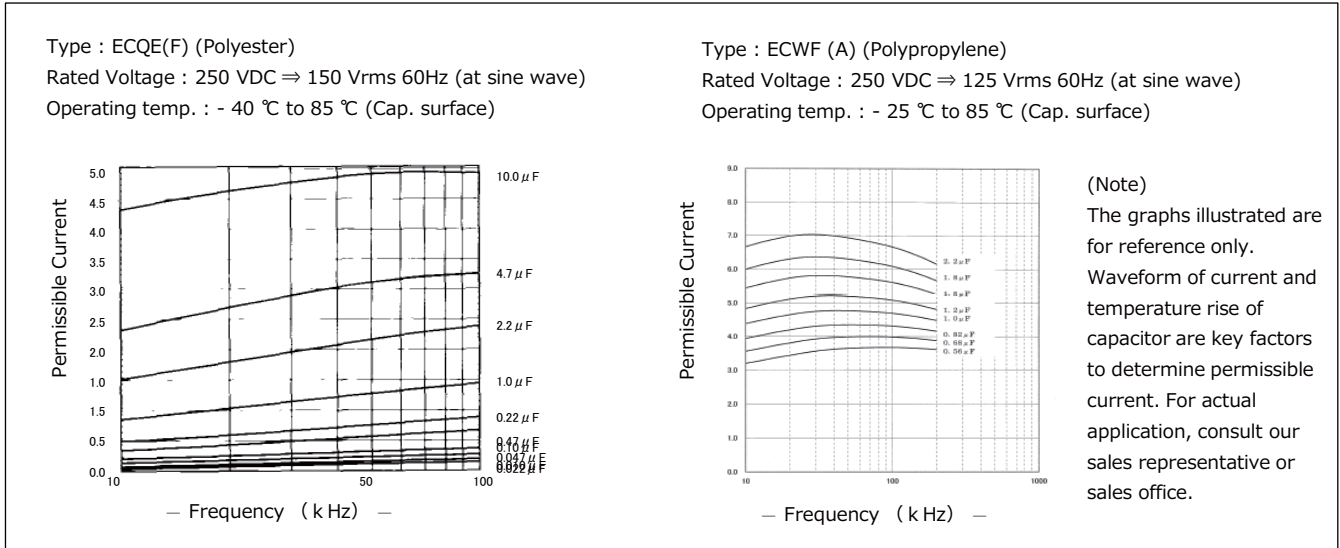

2.4 Permissible current to pulse current

- When used in switching circuits or snubber circuits a momentary high current pulse may cause local heat generation. This causing the capacitance value to deteriorate or an open circuit condition. Local heat generation may also induce smoke or fire. The pulse permissible current (10000 times) isobtained by the product of dV/dt (V/μs) value that is entering to the specification and capacitance (μF).
- The dV/dt (V/μs) value of a film capacitor is determined by the element structure, and in the metalized type, in particular, the internal evaporated electrode and external takeout electrode are connected by metalized contact (metal spraying), and hence due caution is needed because the upper limit of dV/dt value is low.
- The dV/dt values corresponding to rated voltage and capacitance value of representative types are shown in page 6. When used in a high current pulse circuit, check the pulse permissible current (Ao-p).
- Please contact with us, If pulses are applied more than 10,000 times.

<How to determine pulse permissible current>

- When voltage V(V) is applied to capacitor C (F for farad), the electric charge Q(C) is expressed in formula ①.

$$Q=C.V.....①$$

- The charging current I(A)flow in the capacitor at this time is expressed in formula ②.

$$I=dQ/dt.....②$$

- Differentiating both sides of formula ① by timet and putting into formula ② yields formula ③.

$$dQ/dt=C.dV/dt$$

$$I=C.dV/dt .....③$$

- Therefore, the pulse current is determined as theproduct of the capacitance value C (μF) andvoltage change dV/dt per μs.

product of the capacitance value C (μF) and voltage change dV/dt per μs.

(Example) In the case of ECQE4224KF (permissible dV/dt)

Rated voltage : 400VDC,

Capacitance : 0.22μF,

permissible dV/dt value : 37

pulse permissible current : 0.22 (μF)×37≒8 Ao-p

(however, number of repetitions is 10,000 times or less), that is, momentary pulse current can be used up to 8 Ao-p.

Make sure the rms current is within the permissible value.



[ECQE (F) Permissible dV/dt value<within 10,000pulses>]

Unit : V/μs

(Cap. :μ F)	Type			
	ECQE(F) 100VDC	ECQE(F) 250VDC	ECQE(F) 400VDC	ECQE(F) 630VDC
103 (0.010)			131	273
123 (0.012)				
153 (0.015)				
183 (0.018)				
223 (0.022)				
273 (0.027)				
333 (0.033)				
393 (0.039)				
473 (0.047)				
563 (0.056)				
683 (0.068)				
823 (0.082)				
104 (0.10)				
124 (0.12)				
154 (0.15)				
184 (0.18)				
224 (0.22)				
274 (0.27)				
334 (0.33)				
394 (0.39)				
474 (0.47)				
564 (0.56)				
684 (0.68)				
824 (0.82)				
105 (1.0)				
125 (1.2)				
155 (1.5)				
185 (1.8)				
225 (2.2)				
275 (2.7)				
335 (3.3)				
395 (3.9)				
475 (4.7)				
565 (5.6)				
685 (6.8)				
825 (8.2)				
106 (10.0)				
	22	18	22	48
	*(10.0P)	*(15.0P)	*(22.5P)	
	11	10	18	48
	*(15.0P)	*(22.5P)	*(27.5P)	*(27.5P)
	6	8		
	*(22.5P)	*(27.5P)		

⚠ Caution!  
Protective means for safety should be provided in case the pulse and rms current may exceed the

\* Asterisk denotes the lead pitch.  
The value of dV/dt is mainly determined by the lead spacing (element width) and element sectional area.

**3. Operating temperature range**

**3.1 Own temperature rise**

When the film capacitor is used in an AC circuit, especially in high frequency application, the capacitor generates heat by itself from the flow of current. If the self heat generation is large, the capacitor may deteriorate, and smoke or fire may occur. Check the self heating temperature rise value in actual conditions of use, and use within the limit specified.

Measure the own temperature rise value in indoor, wind-free condition.

\* The details of self heating temperature rise value are described in the specification. (Please contact us details as the specifies value varies by each type.)

**3.2 Operating temperature range**

The operating temperature range of the film capacitors varies with the dielectric material (kind of films), and the usable temperature range is specified in the each model.

It must be noted, however, that the temperature range mentioned in the catalogue is the surface temperature of the film capacitor, not the ambient temperature of the capacitor.

In actual use, make sure the sum of the ambient temperature + capacitor's self heating temperature rise value (within specified value), that is, the capacitor surface temperature should be within the rated operating temperature.

**⚠ Caution!**

When used above the specified operating temperature, dissipation factor ( $\tan\delta$ ) increase, and the self heat generation may exceed the permissible value, possibly causing deterioration of dielectric film, short circuit, and smoke or fire.

If there is cooling plate of other part or any resistance heated to high temperature near the film capacitor, the capacitor may be locally heated by the radiation heat, exceeding the operating temperature range, and smoke or fire may be caused.

Check the capacitor surface temperature at the heat source side.

**4. Other cautions****4.1 Flame retardation**

- The dielectric film is not a flame retardant material.
- In the ECQE , ECWF, and ECWH types, flame retardant epoxy resin (94V-0) is used in the coating resin.

**4.2 Environments of use****4.2.1 When used in humid environments**

When used for a long period in humid environments, the elements absorb moisture through the coating with the passing of the time. The water oxidizes the electrode (evaporated film and metalized contact), and leads to trouble. Also, make sure the capacitance value can be very large depending on type of the capacitor.

**4.2.2 When using in high temperature environment**

When ECQUG is used in high temperature environment (more than 70°C), it may be possible to cause leaking oil from the capacitor. However, the quality and reliability of the capacitor is not affected by the leaking oil. But, please don't use the part which may cause a point of tact obstacle by oil and this condenser by a same set.

**4.2.3 Cautions on gas atmosphere**

When using in the oxidizing gas such as hydrogen chloride, hydrogen sulfide and sulfurous acid, the evaporated electrode (Aluminum) or metalized contact (zinc compound) may be oxidized, may result in smoke or fire. Avoid such atmosphere.

**4.2.4 When using by resin coating**

When using resin coating or resin potting components to improve humidity resistance or gas resistance, or to fix parts in place. Please contact with us.

- The solvent or the constituent in the resin may permeate into the metalized contact or electrode (aluminum foil or evaporated film) to deteriorate characteristics.
- When hardening the resin, chemical reaction heat (curing heat generation) occurs, which may adversely affect the capacitor.
- In the case of the lead type capacitors, be sure to test and evaluate enough for the thermal stress to the capacitor.

**4.2.5 Other**

- When using in the following conditions, the characteristic may be deterioration. Please don't use at such conditions.
  - The place that took water or oil.
  - The place that exposed to the direct sunlight.
  - The place that radiated ozone, ultraviolet rays and radiation rays.
- Please consider so that dust doesn't collect. That will be the cause of the characteristic deterioration (short circuit, etc.).

**4.3 Changes in capacitance value over time**

- The capacitor characteristics change characteristic depending on its ambient conditions and environmental conditions. In natural conditions, there is a certain capacitance change due to the humidity of the circumstance. The degree of such capacitance changes varies with the dielectric material, coating material, and structure. Therefore, we ship considering these changes, but we only guarantee capacitance value until delivery (without each arrangements.)
- For use in a circuit where time constant and capacitance precision are required, use the products of polypropylene film ECWFD/(A)/(L) , ECWH(A) or film ECHU(X)/(C) which vary less with time.

#### 4.4 Hum (Buzz)

- Hum produced by capacitors due to mechanical vibration of the film is caused by the coulomb force which exists between electrodes of opposite polarity. A louder hum is produced when applied voltage waveform has distortion, and/or higher frequency component, etc. Although Hum does not spoil characteristics of capacitors, when being used around the audio frequency, please check it.

#### 4.5 Storing method, storing conditions

- It must be noted that the solderability of the external electrode may deteriorate when stored in an atmosphere filled with moisture, dust, or a reactive oxidizing gas (hydrogen chloride, hydrogen sulfide, sulfuric acid).
- Should not location with particularly high temperature and high humidity, and store in conditions not exceeding 35 °C and 85 % RH.
- When it is kept for a long term, the solderability of the external electrode may deteriorate for oxidation of electrode surface. So we recommend keeping-period is within 6 month. Further, it's different in the condition depending on the items, so please inquire for details.

#### 4.6 Handling Pre cautions

- Sudden charging or discharging may cause deterioration of capacitor such as shorting and opening due to charging or discharging current. When charging or discharging, pass through a resistance of 20 to 1000  $\Omega/V$  or more.
- When connecting multiple film capacitors in parallel in withstand voltage test or life test, connect a resistance of 20 to 1000  $\Omega/V$  or more in series to each capacitor.
- Be careful not to scratch the capacitor surface with sharp edges (such as screwdriver, soldering iron, pincers, chassis). Don't apply excessive load to the lead wire (at the time of re-processing of lead wire, etc.).
- If the capacitor is dropped by mistake, its characteristics may be damaged. Don't use such a capacitor. (If reusing, check the quality sufficiently.)
- In the case of leaded type capacitor, be careful not to apply excessive force to the lead wire root area, which may cause cracking or separation in the coating resin near the root area.
- No dust or water should be permitted to remain on the surface of capacitor terminals as this may cause electrical leakage or corrosion.
- When used for noise suppression between lines and between line to earth when voltage is more than 30VAC and more than 45VDC, covering peripheral resin part by flame retardant material or flame retardant case (for avoiding fire) is recommended.
- Chip type capacitor is developed assuming normal use of surface mounting parts. Abnormal use (ex: piling up two capacitors, mounting capacitor in upright position, etc.) should not be permitted. Please consult us in advance if used in different way from normal.

#### 4.7 Additional Points

- The precautions in using film capacitors follow the JEITA RCR-2350 D "Safety Application Guide for fixed plastic film capacitors for use in electronic equipment". Please refer to the above guideline.
- Product specifications, materials and other points mentioned in the catalog may be changed without notification.

##### (Note 1) Rated voltage

The maximum voltage that can be applied continuously in spite of temperature is called as the rated voltage in our company. It's different from the standards of JIS and IEC.

##### \* Definition of our company

The maximum voltage that can be applied continuously within the category temperature range.

- \* Even when needing derating voltage at high temperature, the voltage after derating is called the rated voltage. Therefore the maximum voltage that can be applied continuously at upper category temperature is being also called the rated voltage.

**! Guidelines and precautions (Lead type)**

(Target product : ECQE, ECWF, ECWH, ECQU)

**1. Soldering**

The heat resisting temperature of the film capacitor varies with the type of dielectric film, structure of the capacitor, manufacturing method, etc.

When mounting, set the mounting temperature so that the capacitor inside (element) temperature is be lower than the mounting heat resisting temperature given below.

If the capacitors go through the high temperature both after soldering , be sure to check the temperature till decreasing.

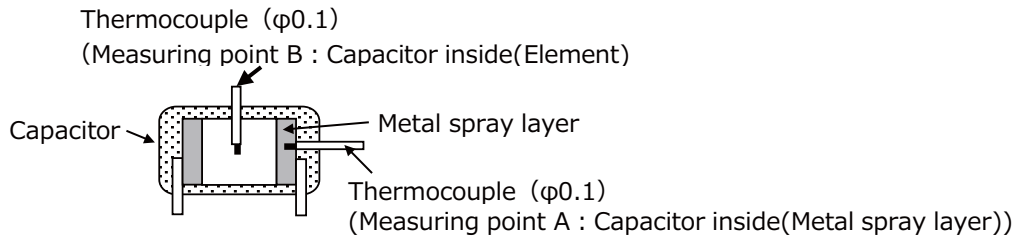

Dielectric	Type	Mounting heat resisting temperature	
		Measuring point A	Measuring point B
Polypropylene	ECWF(L) 400V 0.022μF~0.11μF, 630V 0.01μF~0.043μF ECWF(A)	135°C	125°C
	ECWF(L) 400V 0.12μF~2.4μF, 630V 0.047μF~1.3μF ECWFE 630V, ECWFG 630V	145°C	125°C
	ECWH(A) ,ECWH(V), ECWFD 630V	135°C	125°C
	ECWH(C)	140°C	125°C
	ECWFD 450V	135°C	—
	ECQUA, ECWFE 450V	125°C	—
	ECQE(F)	—	120°C
	ECQE(B), ECQE(T), ECQUL, ECQUG	160°C	—

**<Cautions for mounting>**

- Solder within the following temperature condition range. (Dipping times is within twice, the second dipping should be carried after the capacitor itself has returned to the normal temeperature)(Example)

Notice:  
The soldering condition shows one example. The temperature of the capacitors depend on several parameters for example soldering machine size , machine structure, temperature control method, etc..  
Should measure the temperature of the capacitors and confirm the temperature under the above table.

**Conditions**

P. W. Board	Thickness t= 0.8mm or more
Pre-heating	Measurement temperature 120 °C within 1 minute (Back side of the P. W. Board around the capacitor)
Capacitor	Raised from P,W. board (Crimped lead)

- The film capacitor has lower mounting heatresistingtemperature than other capacitors,therefore the following cautions are needed.  
Avoid passing through an adhesive curing oven. After adhesive curing, the capacitor should be inserted in the P.W. board and solder. (When passing an adhesive curing oven, breakage of coating resin or deterioration in capacitor characteristic may be caused.)
- Avoid reflow soldering. (When use in reflow soldering, breakage of coating resin or deterioration in capacitor characteristic may be caused.)

- When using in multilayer Printed wiring board, or in the case of a capacitor with a copper lead wire, please contact with us. (In the case of copper lead wire, the thermal conductivity of the copper wire is high, and the internal temperature of the capacitor rises rapidly and may exceed the mounting heat resisting temperature.)

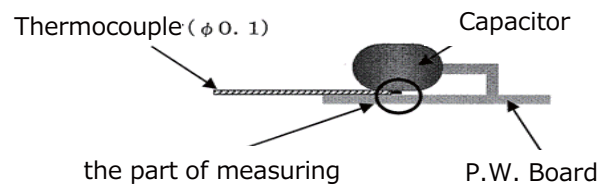

**2. Washing the mounted boards**

The film capacitor varies significantly in the effect of washing depending on the structure and material, and generally it is less affected by CFC or alcohol derivative washing solvent, and is likely to be affected by highly polar solvent.

The lead type film capacitor is coated with an epoxy resin excellent in chemical resistance, and is hardly affected by detergent, but it is recommended to be washed for short duration.

Applicability of detergents in film capacitors is listed for reference.

**<List of applicability of detergents>**

Washing condition		Lead type	Box type	
			ECWFE	ECWFG
Solvent	Alcohol	Ethanol Ultrasonic washing or immersion washing for 5 min	○	○
		Isopropyl alcohol (IPA) Ultrasonic washing or immersion washing for 5 min	○	○
	Silicon	FRW-17Ultrasonic washing for 5 min, 60 °C ⇒FRW-1NUltrasonic washing for 5 min, 60 °C ⇒FRW-100Steam drying for 1 min, 100 °C	○	○
		Halogen	HCFC141b-MS Ultrasonic washing or immersion washing for 5 min	○
	Petroleum hydrocarbon	P3 Cold Cleaner 225S Ultrasonic washing for 5 min 60 °C ⇒ IPA ultrasonic rinsing for 5 min at ordinary temperature ⇒ hot air drying for 5 min, 40 °C	○	○
		Toluene Ultrasonic washing or immersion washing for 5 min	○	○
Terpene	Terpene Cleaner EC-7 Spray washing for 5 min at ordinary temperature ⇒ purified water spraying for 5 min, 50°C ⇒ hot air drying for 5 min, 80°C	○	○	
Water	Purified water	Ultrasonic washing for 5 min 60 °C ⇒ wind-free dryingfor 5 min, 85 °C	○	○
	Surface active	Clean Through 750H Ultrasonic washing for 5 min, 60 °C ⇒ purified water ultrasonic washing for 5 min, 60 °C ⇒ hot air drying for 5 min, 85 °C	○	○
		Clean Through 750L Ultrasonic washing for 5 min, 60 °C ⇒ purified water ultrasonic washing for 5 min, 60 °C ⇒ hot air drying for 5 min, 85 °C	○	—
		Clean Through 710M Ultrasonic washing for 5 min, 60°C ⇒ purified water ultrasonic washing for 5 min, 60 °C ⇒ hot air drying for 5 min, 85 °C	○	—
		Clean Through LC-841 Ultrasonic washing for 5 min, 60 °C ⇒ purified water ultrasonic washing for 5 min, 60 °C ⇒ hot air drying for 5 min, 85 °C	○	○
		Pine Alpha ST-100S Ultrasonic washing for 5 min, 60 °C ⇒ purified water ultrasonic washing for 5 min, 60°C ⇒ hot air drying for 5 min, 85 °C	○	○
		Aqua Cleaner 210SET Shower washing for 1 min, 60 °C ⇒ purified water ultrasonic washing for 5 min, 60 °C ⇒ hot air drying for 5 min, 85 °C	○	○
○ : Washing enabled    × : Washing disabled    — : Not confirmed				

**<Wash-free flux>**

Wash-free	Low residue flux	ULF-500VS	○	○
	Inactivated flux	AM-173	○	○

**3. Temperature measuring in soldering of film capacitor**

When using film capacitor of low heat resisting temperature in mounting, measure the element temperature profile in mounting in the following manner, and make sure the soldering is done below the heat resisting

**<Preparation of measuring sample>**

Open a hole of about  $\Phi 0.3$  mm to 0.8 mm in the top of the capacitor to the middle of the element, and insert thermocouple ( $\Phi 0.1$ T wire), and fix with adhesive.

**<Measurement of temperature profile>**

As shown below, connect a thermocouple (3 - 4 )m of same type as the thermocouple attached to the capacitor, to the thermocouple of the capacitor as shown below. Mount the sample on the mounting printed wiring board, and pass into the soldering and mounting process, and measure the temperature profile

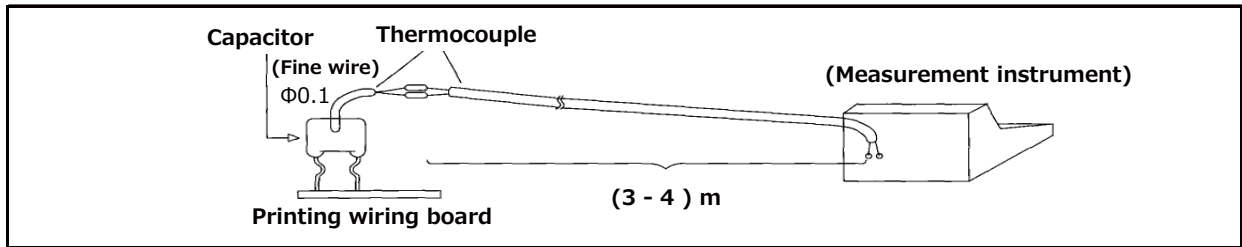

**4. Capacitor for prevention of AC power supply (across the line) noise**

- When using a capacitor across the line as means for prevention of noise, not only is the supply voltage is always applied, but also abnormal surge such as lightning is applied, which may lead to smoke or fire. Therefore, the across-the-line capacitors are strictly regulated in safety standard in each nation, and it is necessary to use the product conforming to the standard.

For using across the line in Japan, use the following models or the above overseas authorized ones.

- ECQE(F) 1000VDC (125VAC) rating
- ECQE(F) 1250VDC (125VAC) rating
- ECQE(F)/(B)/(T) 125VAC (1A) rating
- ECQE(F)/(T) 250VAC (2A) rating

However, when using the ECQE(F)1A/2A, ECQE(B)1A, ECQE(T)1A/2A rating model as across-the-line capacitor, at least one of the following conditions must be satisfied.

1. A varistor with the voltage of the value or less shown in the following table should be connected to the capacitor in parallel.
2. A pulse voltage more than the value shown in the table below should not be applied across the capacitor.

(Note) When using together with varistor, check the varistor specification, and select the one free from surge deterioration

Cap. Rated Voltage	Varistor Voltage	Pulse Voltage
125VAC (1A)	250V	250Vo-p
250VAC (2A)	470V	630Vo-p

When Safety standard approval capacitor is used for necessary equipment, please use items of the following table.

**<Representative examples of models authorized in major safety standards in the world>**

Shape	Type	Standard
Plastic case type	ECQUA	UL 60384-14(USA), CSA E60384-14(Canada), EN 60384-14(Europe)
Plastic case type	ECQUL	UL 60384-14(USA), CSA E60384-14(Canada), EN 60384-14(Europe)
Plastic case type	ECQUG	UL 60384-14(USA), CSA E60384-14(Canada), EN 60384-14(Europe)

\*Please contact us about CQC(China).

- In the case of the voltage dropper usage, when an abnormal voltage of the surge voltage etc. is applied the capacitance decrease is caused, such as the fuse function in the capacitor operates. In the worst case, the capacitor does not work as voltage dropper. So, please notice an abnormal voltage. At that time, high voltage may be applied to the load side. Therefore, please provide protective means for safety.

单击下面可查看定价，库存，交付和生命周期等信息

[>>Panasonic\(松下\)](#)