

Panasonic
ideas for life

LightPix^{*}
AE20

The tough, compact image sensing
device that is easy to use



LightPix AE20
ARCT1B250E-1 '06.6

Advanced usability, durable design (IP67 waterproof construction)

All functions for lighting, image acquisition (camera) and signal processing (CPU) are contained in this one unit. With software designed to epitomize user-friendliness, settings can be made simply and surely while viewing images on a personal computer.

Fully equipped with a waterproof body structure and functions to assist installation.

LightPix can tackle a variety of tasks even under harsh working conditions.

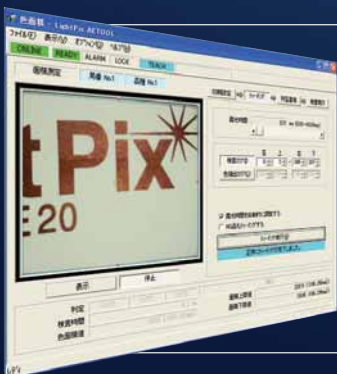

Make Settings Easily

Using free dedicated software, settings can be made simply and surely while viewing images on a personal computer. First-time users easily grasp the settings principles and are aided by such functions as auto-tuning.

Easy Installation

This single unit contains CPU, lighting and camera, which makes installation easy and reduces costs. Can be installed immediately once the required visual field has been selected from the 4 models available.

Stable Detection

As opposed to point measurement, LightPix utilizes a 2-dimensional image capturing element to measure surfaces. This allows inspection over a broader area and enables more stable detection.

Supported Applications

Various applications are supported with a wide range of inspection modes.



Cap Sticker Detection

Color Area

Registers a color on the inspection object and detects the area of that color.

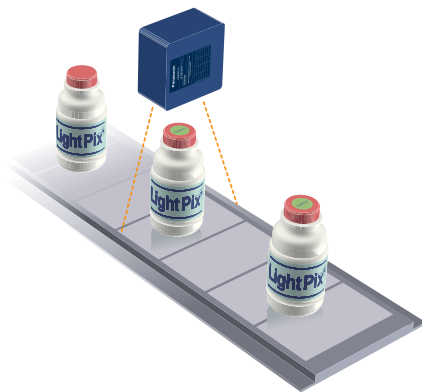

Campaign Sticker Color Discrimination

Color Discrimination

Discriminates which color is closest to the color registered (up to 7).

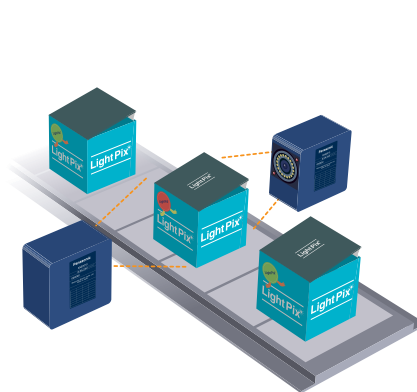

Logo Detection

Color Pattern Matching

Detects colors and patterns on the object which matches the template registered.

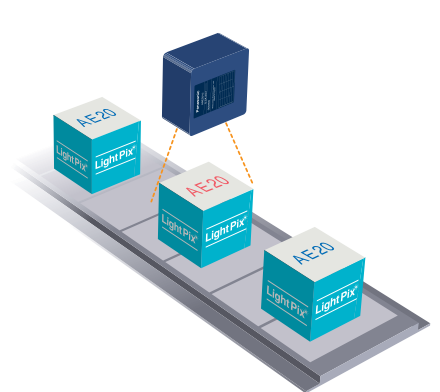
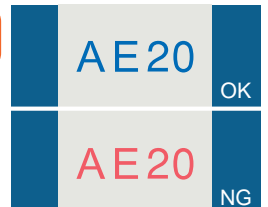

Part/Board/Label Position Inspection

Edge Detection

Detects the position of edges on inspected objects.

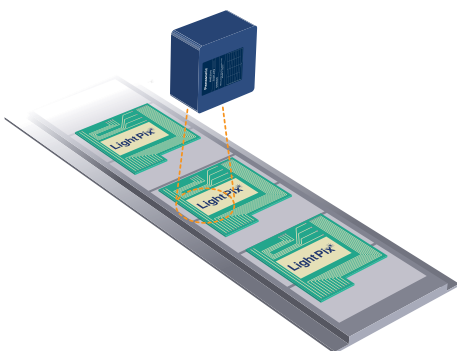

Board/Label Position Alignment Inspection

Apex Detection

Detects the position of the apex of an object.

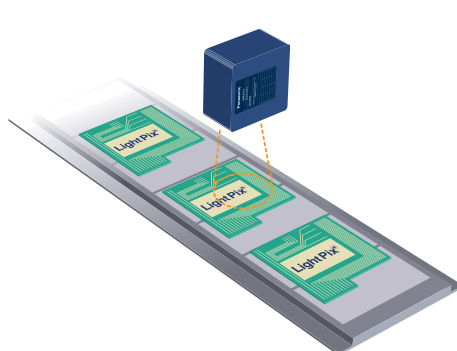

Part Type Inspection

Size Measurement

Detects the size (max. and min.) of an object.

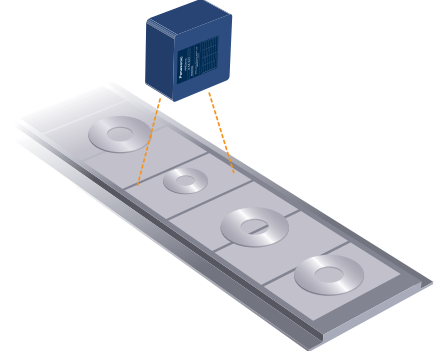

Operation

Operation made even easier in response to workplace conditions.

LightPix
AE20

Easy Settings

Settings can be made easily by anyone from a personal computer, using the dedicated free software AETOOL.

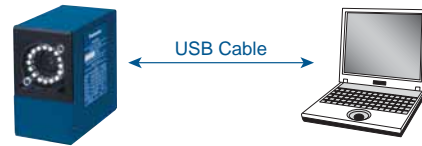
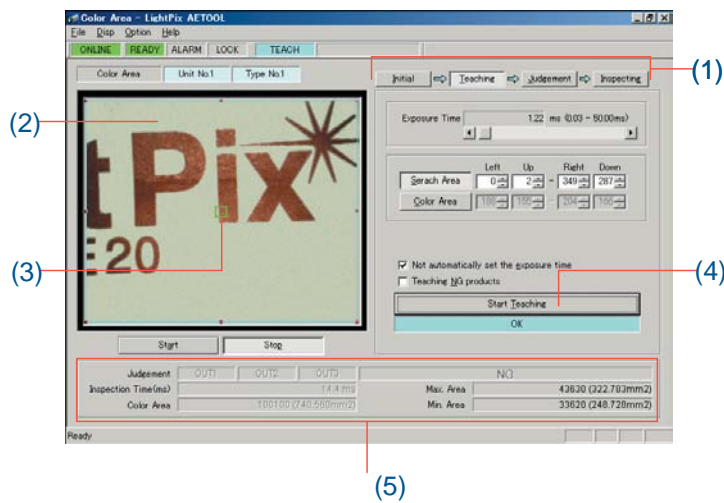

- (1) Settings procedure at a glance.
- (2) Large, clear display giving sharp images of inspection objects.
- (3) Size and position of inspection area can also be changed easily by dragging with the mouse.
- (4) Exposure times, and max. and min. values for judgment criteria can be set automatically with one click of the teaching button.
- (5) Evaluation results, inspection times, evaluation criteria max. and min. values, etc. can be checked on one screen, showing the current status at a glance.

- When multiple LightPix units are in use, saved data files can be copied.
- Using the export function, details on settings can be converted into documents.

AETOOL can be downloaded from the following URL:
<http://www.nais-e.com/vision/>

Industry's
First

Auto-tuning of Exposure Time

Detection of visual field brightness and automatic setting to optimum state.

Exposure time is too short.



Exposure time is too long.



Tuning

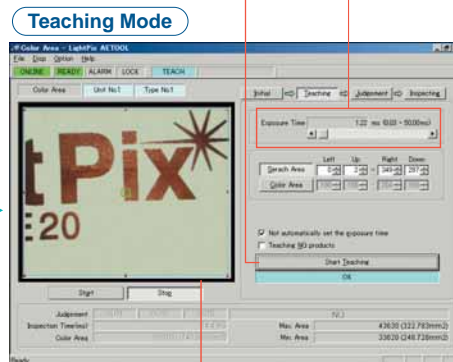

Exposure time is correct.

One-click Operations

- (1) Automatic setting of LightPix AE20 even without any knowledge of cameras or sensors.
- (2) Fine adjustment of exposure time and evaluation criteria max. and min. values also possible for expert users.

Evaluation Criteria Mode





Supports IP67 with its Water- and Dust-resistant Aluminum Body

Supports IP67, so it can be used in environments such as with foodstuff machinery where the entire machinery is washed down.

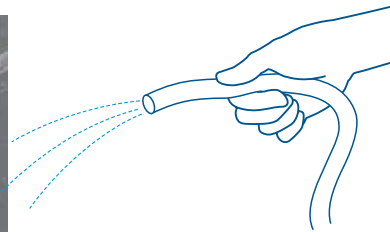

IP67

IP67 is not intended for use under water or with oil.

Guide Light (Red LED) Enables Easy Fitting and Installation

The installation position is correct when 2 points of light from lens-fitted LEDs intersect.

In addition to establishing the correct distance, the guide light allows you to ascertain the orientation of the camera.

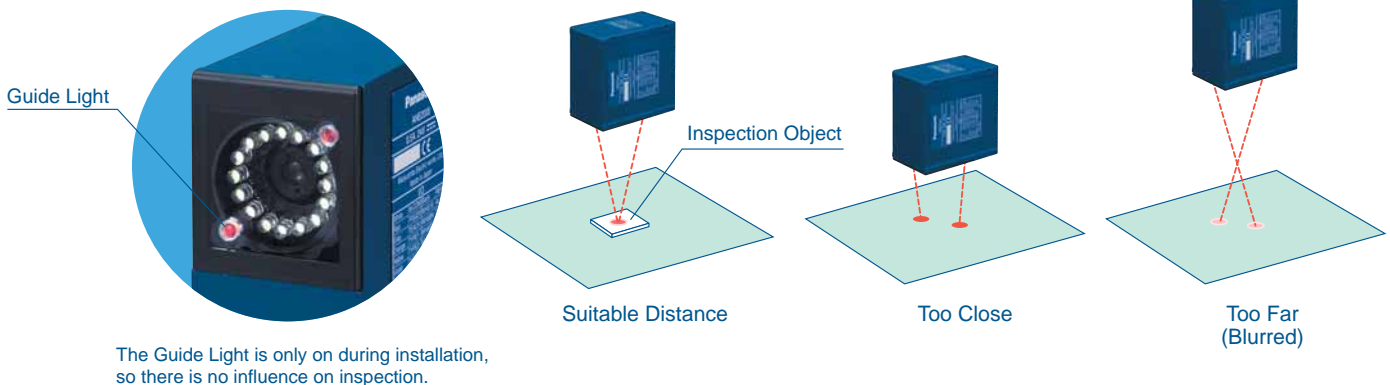

The Guide Light is only on during installation, so there is no influence on inspection.

Up to 8 Images of Rejected Objects Can Be Stored in Real Time in the LightPix Unit

Images of rejects occurring during manufacture can be saved and uploaded to a PC.

Uploaded images can be stored in bitmap format and can be used, for example, as materials for quality control reports.

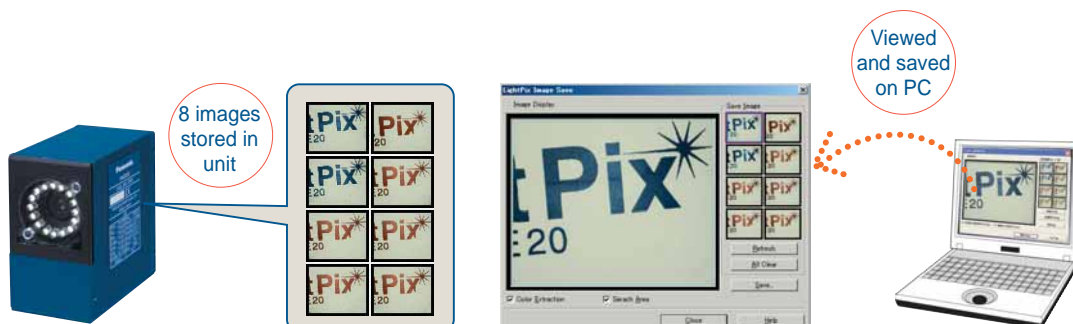

System Configuration Diagram



System Configuration Diagram

Can be connected to many devices such as PCs, operation units, finder units, etc.

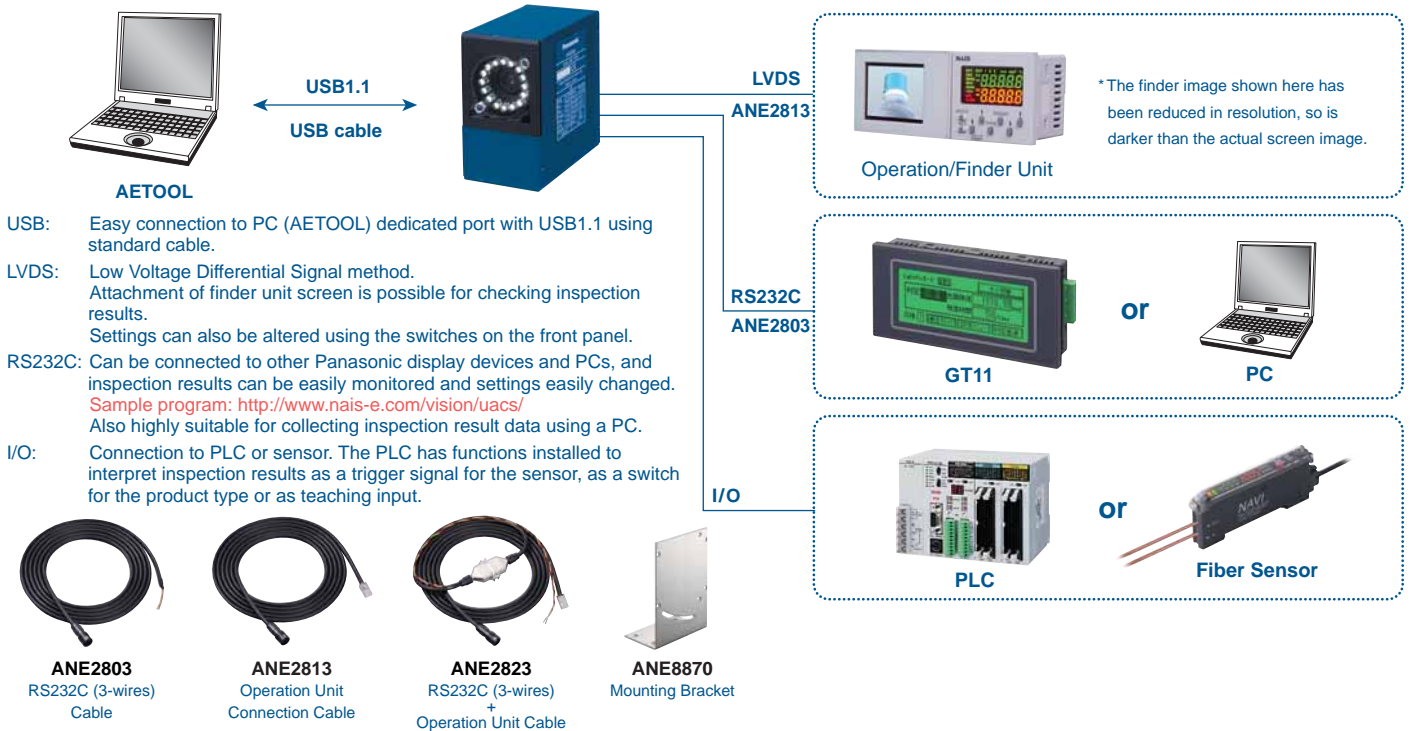

Easy modification of firmware from PC

Various functions can be modified or updated to the latest version at any time.

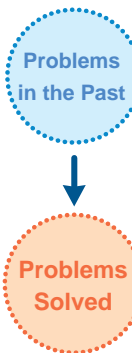

"To prepare a stock for maintenance, I need to buy every model"
 "Even though the latest version has been released, I have to keep using the old version as it is"
 "It is hard to judge which functions best match the application. I want to try out all three, but buying them all is difficult"
 "If the application changes, the model also changes, making stock control very complicated"

Just purchase the product model matching the required visual field and download the firmware. Stock control is also very easy.

Industry's First

Data transfer using software included with AETOOL. Various functions can be modified.

1. Color Area (at time of shipping from factory)
2. Color Discrimination
3. Color and Pattern Matching
4. Edge Detection
5. Apex Detection
6. Size Measurement

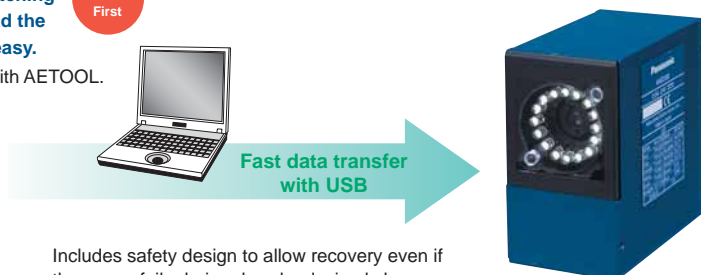

Includes safety design to allow recovery even if the power fails during download, simply by downloading from the PC one more time.

AETOOL can be downloaded from the following URL: <http://www.nais-e.com/vision/>

Part Numbers and Specifications

Part No. List

● System Configuration Products

Name	Part No.	Content
LightPix AE20 Main Unit	ANE2000	Visual Field: 2 × 1.6 mm Installation Distance: 15 mm
	ANE2010	Visual Field: 10 × 8 mm Installation Distance: 45 mm
	ANE2020	Visual Field: 30 × 25 mm Installation Distance: 55 mm
	ANE2030	Visual Field: 80 × 70 mm Installation Distance: 170 mm
LightPix AE20 Optional Cables	ANE2803	For connection to Operation Unit Cable Length: 3 m
	ANE2823	For connection to RS-232C/ Operation Unit. Cable Length: 3 m
LightPix AE10 Operation Unit	ANE11	Setting device for parameter inputs (Accessories: installation fitting)
LightPix AE10 Finder Unit	ANE12	2-inch color LCD display (Accessories: installation fitting)
Mounting Bracket	ANE8870	—
AETOOOL	—	Settings Tool software

General Specifications

● General Specifications

Item	Specification
Rated Operating Voltage	24 V DC
Operating Voltage Range	21.6 to 26.4 V DC (including ripples)
Rated Current Consumption	0.5 A max.
Ambient Temperature in Use	0 to +40°C
Storage Ambient Temperature	-20 to +60°C (no freezing or condensation)
Ambient Humidity in Use	35 to 85 %RH (at 25°C no freezing or condensation)
Storage Ambient Humidity	35 to 85 %RH (at 25°C no freezing or condensation)
Insulation Resistance	100 MΩ max. (500 VDC) *1
Breakdown Voltage	500 V AC/1 min (600 V AC/1 sec) *1
Noise Immunity	1000 V pulse width 50 ns/1 μs (using noise simulator method)
Protective Structure	IP67 *2
Weight	Approx: 300 g (Main Unit)
Vibration Resistance	10 to 55 Hz, 1 sweep/min, Double amplitude of 1.5 mm, 30 min. each in X, Y and Z directions
Shock Resistance	196 m/s ² , 5 times each in X, Y and Z directions

Note *1: Evaluation was carried out with the primary side power supply varistor and capacitor removed from the internal circuit of the device.
Cutoff Current: 10 mA

Note *2: Evaluation was carried out with the USB cable not connected and the waterproof cap in place. This product conforms to EU EMC standards (EN61000-6-4 and EN61000-6-2) in accordance with EMC Directive 89/336/EEC.

Function Specifications

● Main Unit

Item	Specification				
Model	ANE2000	ANE2010	ANE2020	ANE2030	
	Installation Distance (mm)	15 - 0.5	45 - 2.5	55 - 5	170 (145 to 220)
	Visual Field (mm)	2 × 1.6	10 × 8	30 × 25	80 × 70 (70-86 to 100-80)*3
	Resolution (mm)	0.02	0.1	0.3	0.5
Photo Acceptance Unit	Color C-MOS 330,000 pixels				
Valid Pixels	352 horizontal × 288 vertical pixels (100,000 pixels)				
Image Capture Light Source	White LED				
Expected Life (Conditions)	SPEED	High with internal trigger (during continuous measurement)			
	Processing time at time of internal trigger *4	ANE201 * 30 ms (exposure time 2 ms) ANE202 * 30 ms (exposure time 3 ms) ANE203 * 30 ms (exposure time 2 ms) ANE204 * 30 ms (exposure time 3 ms)			
	Shutter timing and interlock (alteration possible from operation unit: 0.03 to 0.5 ms)	White LED			
	Visual Field Marker Light Source	Photo coupler input: 5 points, photoMOS relay output: 5 points			
Parallel	USB 1.1 (Windows XP/2000, ME, 98 (SE))				
USB	Usage possible with optional RS-232C cable				
Serial	Settings possible up to 57600 bits				

● Application

(1) Color Extraction

Item	Specification	
Function Name	Color Area	
Color Resolution	12 colors (Use the Gretag Macbeth Color Rendition Chart for confirmation)	
Function	Detects area of registered color on object	
Execution Time [Execution time at time of internal trigger]	30 ms (approx. 100,000 pixels, data culling: none)	
No. of Registered Items	7 types	
Color Registration Method	Teaching (teaches color)	
Evaluation Input Value	Upper and lower limit values for area judgment	
Serial	RS-232C (when using optional cable)	
	I/O Command	Trigger Input, Type Switching (types 1 to 7)
Input	Teaching Command	Exposure Time Setting
	Evaluation Criteria Command	Upper and lower values for area
Output	Evaluation result (OK/NG), computation result and error output	
	Power I/O Cable	
Parallel	Trigger Input, Type Switching (types 1 to 7), Mode Switching (Run/Teaching)	
	Evaluation result (OK/NG), READY, Alarm	

Note *3: With ANE2030, the visual range changes between 70 × 56 mm to 100 × 80 mm depending on the installation distance.

Note *4: Processing time at the time of the internal trigger changes according to the application software. If an external trigger is used and the measurement interval increases, LED life can be extended.

(2) Color Discrimination

Item	Specification	
Function Name	Color Discrimination	
Color Resolution	12 colors (Use the Gretag Macbeth Color Rendition Chart for confirmation)	
Function	Distinguishes which color among a maximum of 7 registered colors	
Execution Time [Execution time at time of internal trigger]	High 60 ms (approx. 6,000 pixels, data culling: 1/16)	
	Middle 180 ms (approx. 25,000 pixels, data culling: 1/4)	
No. of Registered Items	Low 600 ms (approx. 100,000 pixels, data culling: none)	
	7 types	
Color Registration Method	Teaching (teaches color)	
Evaluation Input Value	Upper and lower limit values for area judgment	
Serial	RS-232C (when using optional cable)	
	I/O Command	Trigger Input, Type Switching (types 1 to 7)
Input	Teaching Command	Exposure Time Setting
	Evaluation Criteria Command	Upper and lower values for area
Output	Evaluation result, type No., computation result, error output	
	Power I/O Cable	
Parallel	Trigger Input, Type Switching (types 1 to 7), Mode Switching (Run/Teaching)	
	Evaluation result, type No., READY, Alarm	

(3) Edge Detection

Item	Specification	
Function Name	Edge Detection	
Detection Capability	Resolution (differs according to speed)	
Execution Time [Execution time at time of internal trigger]	High 60 ms (approx. 6,000 pixels, data culling: 1/16)	
	Middle 180 ms (approx. 25,000 pixels, data culling: 1/4)	
No. of Registered Items	Low 600 ms (approx. 100,000 pixels, data culling: none)	
	7 types	
Color Registration Method	Teaching (teaches color)	
Evaluation Input Value	Extent of permissible area around base point	
Serial	RS-232C (when using optional cable)	
	I/O Command	Trigger Input, Type Switching (types 1 to 7)
Input	Teaching Command	Exposure Time Setting, Binarization Level
	Evaluation Criteria Command	Permissible area (X/Y)
Output	Evaluation result (OK/NG), computation result, error output	
	Power I/O Cable	
Parallel	Trigger Input, Type Switching (types 1 to 7), Mode Switching (Run/Teaching)	
	Evaluation result (OK/NG), READY, Alarm	

(4) Apex Detection

Item	Specification	
Function Name	Apex Detection	
Detection Capability	Resolution (differs according to speed)	
Execution Time [Execution time at time of internal trigger]	High 60 ms (approx. 6,000 pixels, data culling: 1/16)	
	Middle 180 ms (approx. 25,000 pixels, data culling: 1/4)	
No. of Registered Items	Low 600 ms (approx. 100,000 pixels, data culling: none)	
	7 types	
Color Registration Method	Teaching (teaches base point)	
Evaluation Input Value	Extent of permissible area around base coordinate	
Serial	RS-232C (when using optional cable)	
	I/O Command	Trigger Input, Type Switching (types 1 to 7)
Input	Teaching Command	Exposure Time Setting, Binarization Level
	Evaluation Criteria Command	Permissible area (X/Y)
Output	Evaluation result (OK/NG), computation result, error output	
	Power I/O Cable	
Parallel	Trigger Input, Type Switching (types 1 to 7), Mode Switching (Run/Teaching)	
	Evaluation result (OK/NG), READY, Alarm	

(5) Size Measurement

Item	Specification	
Function Name	Size Measurement	
Detection Capability	Resolution × 2 times (differs according to speed)	
Function	High Resolution × 8 times	
	Middle Resolution × 4 times	
Execution Time [Execution time at time of internal trigger]	Low Resolution × 2 times	
	7 types	
Color Registration Method	Teaching (teaches base vertical size (max./min.) and base horizontal size (max./min.))	
Evaluation Input Value	Permissible range from vertical base point (max./min.) and horizontal base point (max./min.) and min. detection size	
Serial	RS-232C (when using optional cable)	
	I/O Command	Trigger Input, Type Switching (types 1 to 7)
Input	Teaching Command	Exposure Time Setting, Binarization Level
	Evaluation Criteria Command	Permissible range for X max. width, X min. width, Y max. width and Y min. width
Output	Evaluation result (OK/NG), computation result, error output	
	Power I/O Cable	
Parallel	Trigger Input, Type Switching (types 1 to 7), Mode Switching (Run/Teaching)	
	Evaluation result (OK/NG) → OUT1: max. evaluation result, OUT2: min. evaluation result, READY, Alarm	

(6) Color and Pattern Matching

Item	Specification	
Function Name	Color and Pattern Matching	
Detection Capability	Resolution (differs according to speed) The speed setting sets the data compression during search.	
Function	Resolution × 2 times (8 compression → 4 compression → 2 compression)	
	Resolution (8 compression → 4 compression → no compression)	
Execution Time	Resolution (4 compression → no compression)	
	Computations time (84 × 48 pixel template, default settings) is as a guideline only. Computation time changes according to template size and individual settings.	
No. of Registered Items	High 100 ms	
	Middle 200 ms	
Type Registration Method	Low 400 ms	
	7 types	
Color Registration Method	Teaching (Registers a template)	
Evaluation Input Value	Permissible range around center coordinates (X coordinate), (Y coordinate) of the template, correlation value (0 to 100)	
Serial	RS-232C (when using optional cable)	
	I/O Command	Trigger Input, Type Switching (types 1 to 7)
Input	Teaching Command	Exposure Time Setting, Binarization Level
	Evaluation Criteria Command	Permissible range for X coordinate and Y coordinate
Output	Evaluation result (OK/NG), computation result (center coordinates of template, X and Y coordinates, and evaluation result), error output	
	Power I/O Cable	
Parallel	Trigger Input, Type Switching (types 1 to 7), Mode Switching (Teaching/Run/Run-View)	
	Evaluation result (OK/NG) → OUT1: result whether detected or not, OUT2: X coordinate evaluation result, OUT3: Y coordinate evaluation result, READY, Alarm	

* The total processing time from receiving the trigger input to output is calculated as follows:
Total Processing Time = Exposure Time + Data Transfer Time (3.8 ms) + Computation Time

Rich Visual Field Lineup

High-precision inspections can be carried out with the optimum visual field size.

● Actual Size of Visual Fields

80 × 70 mm

30 × 25 mm

10 × 8 mm

2 × 1.6 mm

Model No.	Visual Field Size	Distance from Object
ANE2000	2 × 1.6 mm	15 mm
ANE2010	10 × 8 mm	45 mm
ANE2020	30 × 25 mm	55 mm
ANE2030	80 × 70 mm	170 mm

● Modes

Item	Specification	
Operation Modes	a. Teaching Mode	Sets the search area which stores the evaluation criteria. Set Exposure Time With Color Detection/Color Discrimination: Teaching Area With Edge Detection/Size Measurement: Binary Level With Color and Pattern Matching: Template
	b. RUN Mode	Execution Mode
	c. RUN-VIEW Mode	Displays images in the finder while carrying out processing (1 unit of processing approx. 0.3 s)
Environment Settings Modes	a. Speed	(selects communication baud rate)
	b. Device No.	(device number with serial communication)
	c. Output Delay	(evaluation output delay)
	d. Acquisition Delay	(delay between trigger input and image acquisition)
	e. Trigger Selection	(switches between continuous measurement/external trigger)
	f. Type on Startup	(initial type setting at startup)
	g. Backlight Shutoff Time	(when shutting the finder unit backlight off)
	h. Auto-save	(switches auto-save ON/OFF)
	i. Initialization	(returns unit to default settings)
	j. Light ON/OFF	(switches white lighting on the main unit ON and OFF)
	k. Processing Speed	(switches between SPEED: High/Middle/Low)
	l. Buffering Delay	
	m. Answer-back ON/OFF Switch	
	[Size Measurement Only]	o. Extracted Color Switch (Black or White)
[Color and Pattern Matching Only]	p. Detailed Settings ON/OFF Switch (switches settings for 0 to 3 ON and OFF)	
q. No. of Search Candidates	(setting for No. of search candidates: 1 to 50)	
r. Exposure Correction ON/OFF Switch	(switches exposure correction function ON/OFF)	

Dimensions

Light Pix
AE20

● Main Unit

ANE2010 / ANE2020 / ANE2030

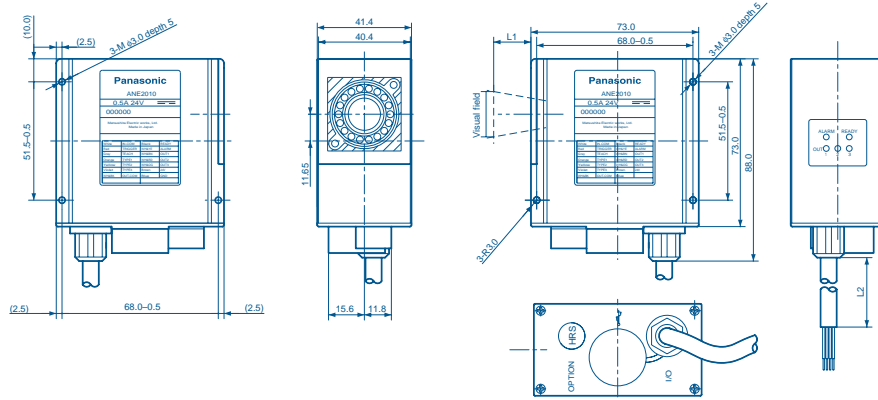

ANE2000

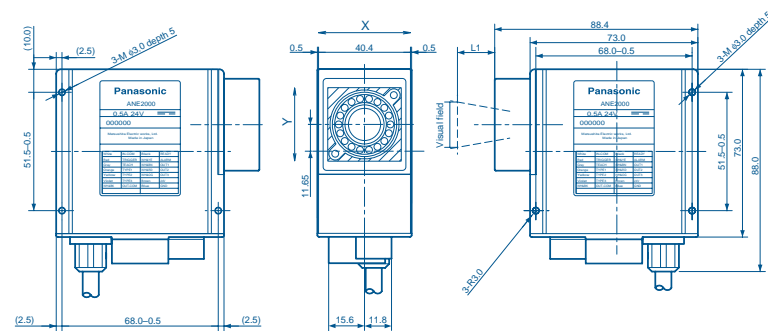

Part No.	Installation distance (mm)	Visual field (Xmm × Ymm)
ANE2000	15	2 × 1.6
ANE2010	45	10 × 8
ANE2020	55	30 × 25
ANE2030	170	80 × 70

● Operation Unit

ANE11

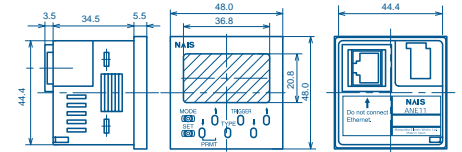

● Finder Unit

ANE12

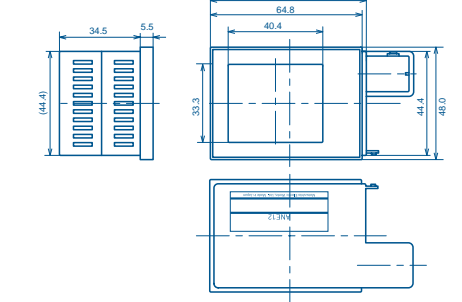

● Mounting Bracket

ANE8870

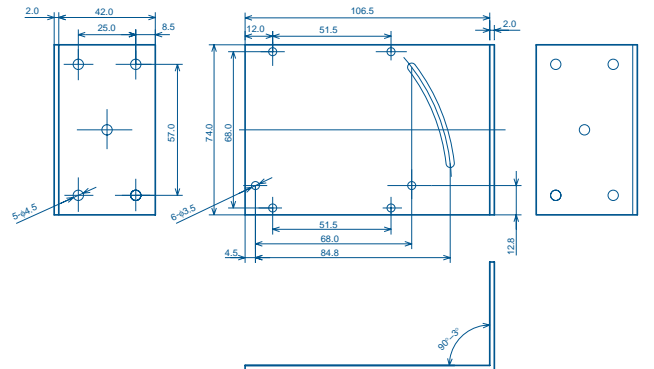

● The monitor displays shown in this catalog are all synthesized for demonstration purposes only.

These materials are printed on ECF pulp.
These materials are printed with earth-friendly vegetable-based (soybean oil) ink.



Please contact

Matsushita Electric Works, Ltd.

Automation Controls Business Unit

■ Head Office: 1048, Kadoma, Kadoma-shi, Osaka 571-8686, Japan

■ Telephone: +81-6-6908-1050 ■ Facsimile: +81-6-6908-5781

<http://www.nais-e.com/>

Panasonic[®]

All Rights Reserved © 2006 COPYRIGHT Matsushita Electric Works, Ltd.

单击下面可查看定价，库存，交付和生命周期等信息

[>>Panasonic\(松下\)](#)