

Choke Coils Discontinued

Series : **Pin terminal**

Type : **09D, 11D, 12D, 16B, 18B, 10E, 12E, 15E, 18E**

Pin terminal inductors featuring small size and high performance

Features

- High - μ and High Bm cores
- Wide inductor range
- Magnetic shield type (E Type)
- RoHS compliant

Recommended Applications

- Appliance, Office automation equipment, Amusement machine, Power circuit for electric device



Explanation of Part Numbers

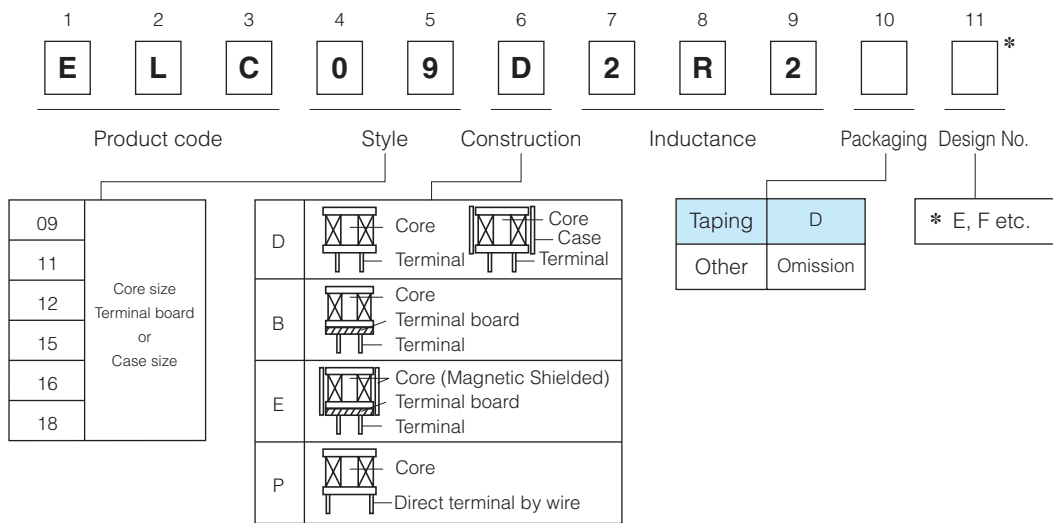



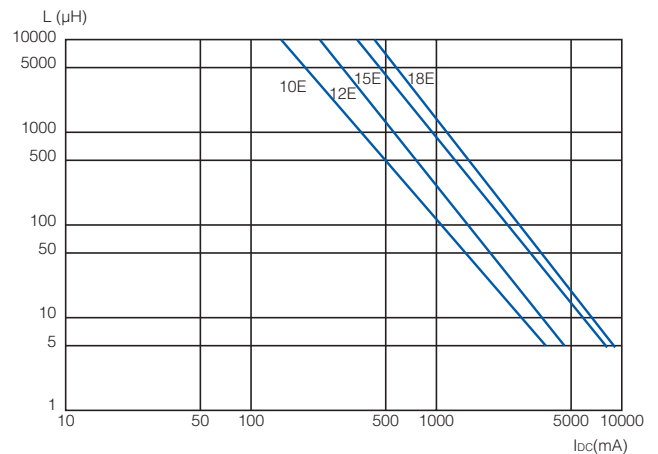
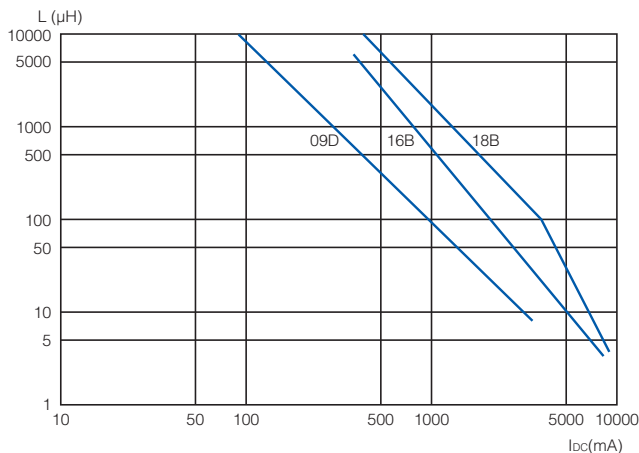



Available I-L Characteristics

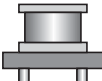
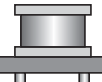

Discontinued

Performance Characteristics by Series

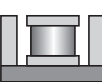
	Type	Construction	External Dimensions D×H (mm)	Inductance (μH)					Current I _{DC} (A)	
				0.1	1.0	10	100	1000		10000
Regular	09D *		φ9.5×8.9 (with case)			2.2			10000	0.08 to 3.5
	11D *		φ11.5×13.9 (with case)			2.2			10000	0.16 to 5.3
	12D		φ12.5×16.5					100	10000	0.27 to 1.9
	16B		φ16.0×23.0			3.3			10000	0.26 to 8.5
	18B		φ20.0×27.0			3.3			10000	0.36 to 8.5
Shield	10E-L		φ10.0×13.0			3.9			8200	0.10 to 2.9
	12E-L		φ13.0×18.5			4.7			10000	0.13 to 4.4
	15E-L		φ16.0×22.0 (3 pin terminal)			5.6			10000	0.30 to 5.4
	18E-L		φ19.0×25.1 (4 pin terminal)			5.6			10000	0.33 to 5.9

* : Taping Available

Discontinued

Examples Type 09D

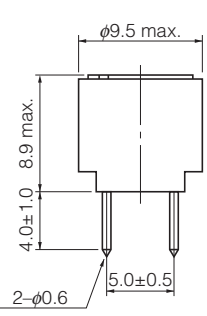
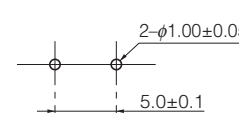
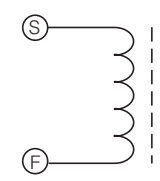
	Part No.	Inductance (μH)	Tolerance (%)	Test Freq. (kHz)	R _{DC} (Ω) [at 20 °C] (Tol.±20 %)	I _{DC} * [at 20 °C] (A)max.
<p>[Dimensions in mm] (not to scale)</p>  <p>Recommended PWB piercing plan</p>  <p>Connection Schematic</p> 	ELC09D2R2□F	2.2	±20	10	0.012	3.50
	ELC09D2R7□F	2.7			0.013	3.30
	ELC09D3R3□F	3.3			0.015	3.20
	ELC09D3R9□F	3.9			0.016	3.10
	ELC09D4R7□F	4.7			0.018	3.00
	ELC09D5R6□F	5.6			0.019	2.90
	ELC09D6R8□F	6.8			0.021	2.80
	ELC09D8R2□F	8.2			0.024	2.60
	ELC09D100□F	10.0			0.027	2.50
	ELC09D120□F	12.0			0.031	2.30
	ELC09D150□F	15.0			0.035	2.10
	ELC09D180□F	18.0			0.038	2.00
	ELC09D220□F	22.0			0.051	1.80
	ELC09D270□F	27.0	0.058		1.60	
	ELC09D330□F	33.0	0.081		1.40	
	ELC09D390□F	39.0	0.087		1.30	
	ELC09D470□F	47.0	0.110		1.20	
	ELC09D560□F	56.0	0.130		1.10	
	ELC09D680□F	68.0	0.140		1.00	
	ELC09D820□F	82.0	0.160		0.90	
	ELC09D101□F	100.0	0.200		0.82	
	ELC09D121□F	120.0	0.250		0.77	
	ELC09D151□F	150.0	0.320		0.74	
	ELC09D181□F	180.0	0.360		0.61	
	ELC09D221□F	220.0	0.410		0.58	
	ELC09D271□F	270.0	0.500		0.52	
ELC09D331□F	330.0	0.650	0.49			
ELC09D391□F	390.0	0.860	0.46			
ELC09D471□F	470.0	0.980	0.39			
ELC09D561□F	560.0	1.100	0.36			
ELC09D681□F	680.0	1.400	0.34			
ELC09D821□F	820.0	1.600	0.30			
ELC09D102□F	1000.0	2.100	0.28			
ELC09D122□F	1200.0	2.400	0.23			
ELC09D152□F	1500.0	2.800	0.21			
ELC09D182□F	1800.0	3.800	0.19			
ELC09D222□F	2200.0	4.400	0.17			
ELC09D272□F	2700.0	6.100	0.16			
ELC09D332□F	3300.0	7.000	0.14			
ELC09D392□F	3900.0	8.000	0.13			
ELC09D472□F	4700.0	11.200	0.12			
ELC09D562□F	5600.0	12.600	0.11			
ELC09D682□F	6800.0	14.400	0.10			
ELC09D822□F	8200.0	16.600	0.09			
ELC09D103□F	10000.0	18.800	0.08			

* Allowable DC Current: Smaller current value either when the inductance is -10 % or when the case temperature has risen 45 °C.

Design and specifications are each subject to change without notice. Ask factory for the current technical specifications before purchase and/or use.
Should a safety concern arise regarding this product, please be sure to contact us immediately.

Discontinued

Examples Type 11D

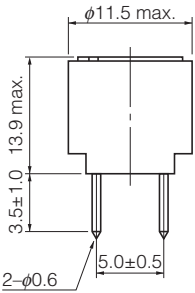
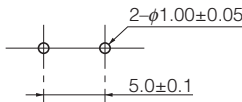
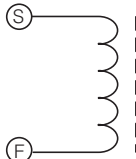
	Part No.	Inductance (μH)	Tolerance (%)	Test Freq. (kHz)	R _{DC} (Ω) [at 20 °C] (Tol.±20 %)	I _{DC} * [at 20 °C] (A)max.
<p>[Dimensions in mm] (not to scale)</p> 	ELC11D2R2□F	2.2	±20	10	0.013	5.30
	ELC11D2R7□F	2.7			0.014	5.10
	ELC11D3R3□F	3.3			0.015	4.90
	ELC11D3R9□F	3.9			0.016	4.80
	ELC11D4R7□F	4.7			0.018	4.70
	ELC11D5R6□F	5.6			0.020	4.60
	ELC11D6R8□F	6.8			0.022	4.40
	ELC11D8R2□F	8.2			0.024	3.90
	ELC11D100□F	10.0			0.029	3.50
	ELC11D120□F	12.0			0.030	3.40
	ELC11D150□F	15.0			0.033	3.30
	ELC11D180□F	18.0			0.037	3.10
	ELC11D220□F	22.0			0.040	2.80
	ELC11D270□F	27.0			0.048	2.70
	ELC11D330□F	33.0			0.051	2.60
	ELC11D390□F	39.0			0.057	2.50
	ELC11D470□F	47.0			0.063	2.30
	ELC11D560□F	56.0			0.071	2.10
	ELC11D680□F	68.0			0.082	2.00
	<p>Recommended PWB piercing plan</p> 	ELC11D820□F			82.0	±10
ELC11D101□F		100.0	0.120	1.80		
ELC11D121□F		120.0	0.160	1.60		
ELC11D151□F		150.0	0.180	1.40		
ELC11D181□F		180.0	0.200	1.30		
ELC11D221□F		220.0	0.230	1.20		
ELC11D271□F		270.0	0.320	1.10		
ELC11D331□F		330.0	0.350	1.00		
ELC11D391□F		390.0	0.400	0.95		
ELC11D471□F		470.0	0.490	0.82		
ELC11D561□F		560.0	0.620	0.73		
ELC11D681□F		680.0	0.780	0.64		
ELC11D821□F		820.0	0.870	0.62		
ELC11D102□F		1000.0	1.100	0.57		
ELC11D122□F		1200.0	1.200	0.52		
ELC11D152□F		1500.0	1.700	0.43		
ELC11D182□F		1800.0	2.000	0.40		
ELC11D222□F		2200.0	2.300	0.38		
ELC11D272□F		2700.0	2.800	0.34		
<p>Connection Schematic</p> 		ELC11D332□F	3300.0			
	ELC11D392□F	3900.0			4.500	0.29
	ELC11D472□F	4700.0			5.200	0.26
	ELC11D562□F	5600.0			6.900	0.23
	ELC11D682□F	6800.0			7.800	0.21
	ELC11D822□F	8200.0			10.600	0.18
	ELC11D103□F	10000.0			11.800	0.16

* Allowable DC Current: Smaller current value either when the inductance is -10 % or when the case temperature has risen 45 °C.

Design and specifications are each subject to change without notice. Ask factory for the current technical specifications before purchase and/or use. Should a safety concern arise regarding this product, please be sure to contact us immediately.

Discontinued

Examples Type 12D

	Part No.	Inductance (μH)	Tolerance (%)	Test Freq. (kHz)	R _{DC} (Ω) [at 20 °C] (Tol. ±20 %)	I _{DC} * [at 20 °C] (A) max.
<p>[Dimensions in mm] (not to scale)</p> <p>Recommended PWB piercing plan</p> <p>Connection Schematic</p>	ELC12D101E	100	±10	10	0.150	1.90
	ELC12D121E	120			0.170	1.78
	ELC12D151E	150			0.190	1.67
	ELC12D181E	180			0.210	1.58
	ELC12D221E	220			0.230	1.55
	ELC12D271E	270			0.270	1.44
	ELC12D331E	330			0.300	1.34
	ELC12D391E	390			0.330	1.32
	ELC12D471E	470			0.380	1.25
	ELC12D561E	560			0.420	1.15
	ELC12D681E	680			0.460	0.98
	ELC12D821E	820			0.650	0.94
	ELC12D102E	1000			0.720	0.87
	ELC12D122E	1200			0.830	0.86
	ELC12D152E	1500			1.270	0.64
	ELC12D182E	1800			1.330	0.63
	ELC12D222E	2200			1.500	0.60
	ELC12D272E	2700			1.890	0.54
	ELC12D332E	3300			2.370	0.48
	ELC12D392E	3900			2.830	0.45
ELC12D472E	4700	3.190	0.41			
ELC12D562E	5600	4.080	0.34			
ELC12D682E	6800	5.740	0.29			
ELC12D822E	8200	6.340	0.28			
ELC12D103E	10000	7.200	0.27			

* Allowable DC Current: Smaller current value either when the inductance is -10 % or when the case temperature has risen 45 °C.

Discontinued

Examples Type 16B

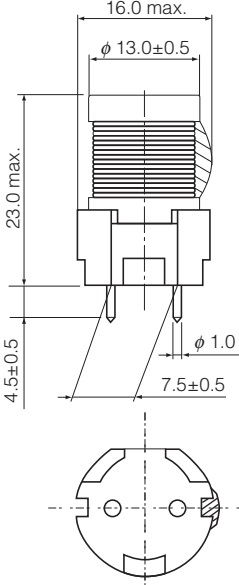
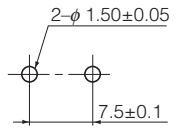
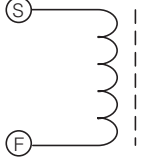
	Part No.	Inductance (μH)	Tolerance (%)	Test Freq. (kHz)	R _{DC} (Ω) [at 20 °C] (Tol.±30 %)** (Tol.±20 %)	I _{DC} .* [at 20 °C] (A)max.
<p>[Dimensions in mm] (not to scale)</p>  <p>Recommended PWB piercing plan</p>  <p>Connection Schematic</p> 	ELC16B3R3L	3.3	±25	10	0.012**	8.50
	ELC16B3R9L	3.9			0.013**	8.00
	ELC16B4R7L	4.7			0.015**	7.80
	ELC16B5R6L	5.6	±20		0.016**	7.40
	ELC16B6R8L	6.8			0.018	6.70
	ELC16B8R2L	8.2			0.019	6.10
	ELC16B100L	10.0			0.022	5.60
	ELC16B120L	12.0			0.023	5.50
	ELC16B150L	15.0			0.026	5.40
	ELC16B180L	18.0			0.028	5.10
	ELC16B220L	22.0			0.031	4.60
	ELC16B270L	27.0			0.034	4.30
	ELC16B330L	33.0			0.039	4.00
	ELC16B390L	39.0			0.042	3.90
	ELC16B470L	47.0			0.045	3.80
	ELC16B560L	56.0	0.051		3.40	
	ELC16B680L	68.0	0.057		3.20	
	ELC16B820L	82.0	0.064		3.00	
	ELC16B101L	100.0	0.072		2.60	
	ELC16B121L	120.0	0.080		2.50	
	ELC16B151L	150.0	0.103		2.20	
	ELC16B181L	180.0	0.115		2.10	
	ELC16B221L	220.0	0.130		1.90	
	ELC16B271L	270.0	0.170		1.60	
	ELC16B331L	330.0	0.200		1.50	
	ELC16B391L	390.0	0.250		1.30	
	ELC16B471L	470.0	0.280		1.20	
	ELC16B561L	560.0	0.380		1.10	
	ELC16B681L	680.0	0.430		1.00	
	ELC16B821L	820.0	0.580		0.88	
	ELC16B102L	1000.0	0.660		0.85	
	ELC16B122L	1200.0	0.740		0.82	
	ELC16B152L	1500.0	0.870		0.74	
ELC16B182L	1800.0	1.220	0.60			
ELC16B222L	2200.0	1.380	0.57			
ELC16B272L	2700.0	1.570	0.54			
ELC16B332L	3300.0	2.000	0.47			
ELC16B392L	3900.0	2.400	0.42			
ELC16B472L	4700.0	3.300	0.36			
ELC16B562L	5600.0	3.700	0.34			
ELC16B682L	6800.0	4.200	0.32			
ELC16B822L	8200.0	5.600	0.28			
ELC16B103L	10000.0	6.400	0.26			

* Allowable DC Current: Smaller current value either when the inductance is -10 % or when the case temperature has risen 45 °C.

Discontinued

Examples Type 18B

	Part No.	Inductance (μH)	Tolerance (%)	Test Freq. (kHz)	R _{DC} (Ω) [at 20 °C] (Tol.±20 %)	I _{DC} * [at 20 °C] (A)max.
<p>[Dimensions in mm] (not to scale)</p> <p>Recommended PWB piercing plan</p> <p>Connection Schematic</p>	ELC18B3R3L	3.3	±20	10	0.010	8.50
	ELC18B3R9L	3.9			0.011	8.00
	ELC18B4R7L	4.7			0.012	7.80
	ELC18B5R6L	5.6			0.013	7.40
	ELC18B6R8L	6.8			0.015	6.80
	ELC18B8R2L	8.2			0.016	6.60
	ELC18B100L	10.0			0.017	6.50
	ELC18B120L	12.0			0.018	6.00
	ELC18B150L	15.0			0.021	5.90
	ELC18B180L	18.0			0.022	5.60
	ELC18B220L	22.0			0.025	5.40
	ELC18B270L	27.0			0.028	4.80
	ELC18B330L	33.0	0.030		4.60	
	ELC18B390L	39.0	0.033		4.40	
	ELC18B470L	47.0	0.037		4.30	
	ELC18B560L	56.0	0.040		4.20	
	ELC18B680L	68.0	0.046		4.00	
	ELC18B820L	82.0	0.051		3.70	
	ELC18B101L	100.0	0.057		3.20	
	ELC18B121L	120.0	0.065		3.00	
	ELC18B151L	150.0	0.072		2.70	
	ELC18B181L	180.0	0.082		2.60	
	ELC18B221L	220.0	0.090		2.40	
	ELC18B271L	270.0	0.110		2.20	
	ELC18B331L	330.0	0.130		1.90	
	ELC18B391L	390.0	0.150		1.80	
	ELC18B471L	470.0	0.210		1.60	
	ELC18B561L	560.0	0.230		1.50	
	ELC18B681L	680.0	0.260		1.40	
	ELC18B821L	820.0	0.340		1.30	
	ELC18B102L	1000.0	0.390		1.10	
	ELC18B122L	1200.0	0.440		1.00	
	ELC18B152L	1500.0	0.580		0.85	
ELC18B182L	1800.0	0.650	0.84			
ELC18B222L	2200.0	0.880	0.75			
ELC18B272L	2700.0	1.200	0.68			
ELC18B332L	3300.0	1.400	0.60			
ELC18B392L	3900.0	1.500	0.57			
ELC18B472L	4700.0	1.700	0.55			
ELC18B562L	5600.0	2.200	0.46			
ELC18B682L	6800.0	2.800	0.45			
ELC18B822L	8200.0	3.100	0.41			
ELC18B103L	10000.0	3.900	0.36			

* Allowable DC Current: Smaller current value either when the inductance is -10 % or when the case temperature has risen 45 °C.

Tape Dimensions in mm for Type 09D (not to scale)

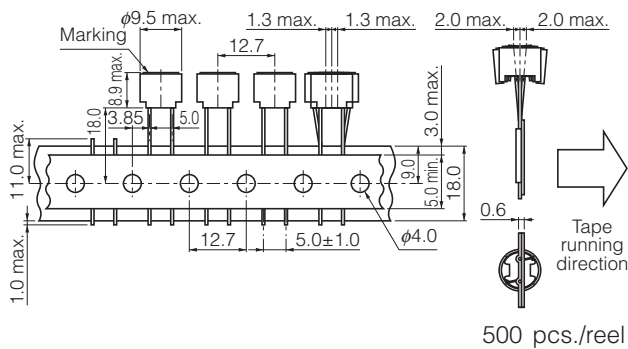

Tape Dimensions in mm for Type 11D (not to scale)

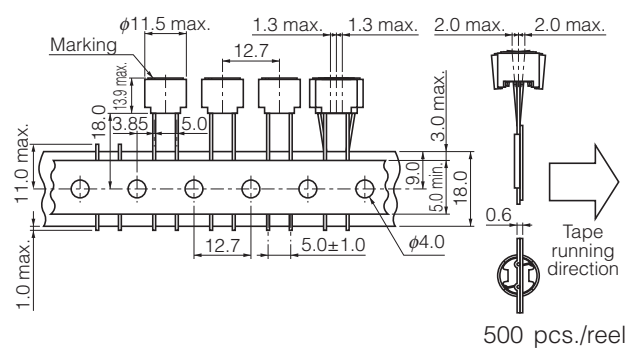

⚠ Safety Precautions

- When using our products, no matter what sort of equipment they might be used for, be sure to make a written agreement on the specifications with us in advance. The design and specifications in this catalog are subject to change without prior notice.
- Do not use the products beyond the specifications described in this catalog.
- This catalog explains the quality and performance of the products as individual components. Before use, check and evaluate their operations when installed in your products.
- Install the following systems for a failsafe design to ensure safety if these products are to be used in equipment where a defect in these products may cause the loss of human life or other significant damage, such as damage to vehicles (automobile, train, vessel), traffic lights, medical equipment, aerospace equipment, electric heating appliances, combustion/gas equipment, rotating equipment, and disaster/crime prevention equipment.
- * Systems equipped with a protection circuit and a protection device
- * Systems equipped with a redundant circuit or other system to prevent an unsafe status in the event of a single fault

⚠ Precautions for use

1. Rated current

The rated current is defined as the smaller value of either the current value when the inductance drops 10 % down from its initial point, or when the average temperature of coil interior rises 45 °C up on power source. Do not operate these coils beyond the specified rated current.

2. Mounting

- ① Cores may be damaged when excessive force or shock is applied.
Do not use products which may have been dropped.
- ② Be careful not to make contact with other parts and consider possible interaction between coils due to magnetic interference.
- ③ Be careful of being too close to heat-radiating parts (high temperature).
- ④ Do not bend the pin-terminals during assembly.
The pin-terminals must connect correctly.
Do not apply them a shock to avoid causing an open or short circuit condition.
- ⑤ The float on PWB must not be after mounting.

3. Soldering

- ① Use flux which will not effect copper wire. (Be sure to use proper amounts of chloride, pH and other solvents)
- ② When using a soldering iron, wait at least 3 minutes before attempting to re-solder.

4. Storage

- ① Avoid high temperatures, high moisture, gases and magnetic fields.
- ② For long term storage of more than 1 year, use the products only after inspecting their outer structure.
(Look for possible rusting of the core and oxidation of the lead wire, which would affect its solderability.)

<Package markings>

Package markings include the product number, quantity, and country of origin. In principle, the country of origin should be indicated in English.

单击下面可查看定价，库存，交付和生命周期等信息

[>>Panasonic\(松下\)](#)