

4.6 mm² mounting area
C×R10: 30V and 40 V load voltage
C×R5: 25 V load voltage

PhotoMOS[®]
RFVSSOP 1 Form A C×R10/C×R5
(AQY22100T)

New



mm inch

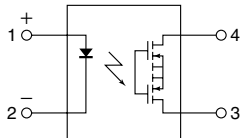

RoHS compliant

FEATURES

1. VSSOP type with further reduction in mounting area
 4.6 mm² mounting area achieved. Approx 29% less than previous product (SON type).
 Contributes to the miniaturization of instruments and higher density mounting.

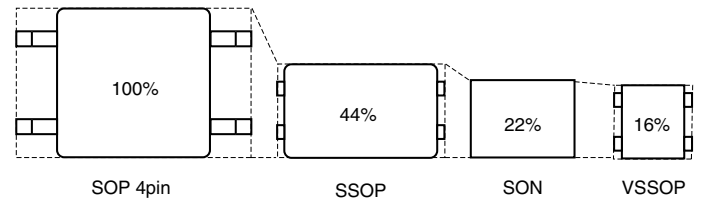

- 2. Low on resistance and low output capacitance available**
- **C×R10**
 - <R type>
 Output capacitance: 14 pF (typical), On resistance: 0.8Ω (typical)
 Output capacitance: 37.5 pF (typical), On resistance: 0.18Ω (typical)
 - <C type>
 Output capacitance: 1.1 pF (typical), On resistance: 9.5Ω (typical)
 - **C×R5**
 Output capacitance: 1.1 pF (typical), On resistance: 5.5Ω (typical)

TYPICAL APPLICATIONS

- 1. Measuring and testing equipment**
 IC tester, Probe card, Board tester and other testing equipment
- 2. Telecommunication equipment**

*Does not support automotive applications.

TYPES

Type			Output rating* ¹		Part No. (Tape and reel packing style)* ²		Packing quantity in the tape and reel
			Load voltage	Load current	Picked from the 1 and 4-pin side	Picked from the 2 and 3-pin side	
AC/DC dual use	C×R10	Low on resistance (R type)	New 30 V	800 mA	AQY221R6TY	AQY221R6TW	1,000 pcs.
			New 40 V	250 mA	AQY221R2TY	AQY221R2TW	
		Low output capacitance (C type)	New 40 V	120 mA	AQY221N2TY	AQY221N2TW	
	C×R5	New 25 V	150 mA	AQY221N3TY	AQY221N3TW		

Notes: *1 Indicate the peak AC and DC values.

*2 Only tape and reel package is available.

For space reasons, only "1R6", "1R2", "1N2" or "1N3" is marked on the product as the part number.

RF VSSOP 1 Form A C×R10/C×R5 (AQY221○○T)

RATING

1. Absolute maximum ratings (Ambient temperature: 25°C 77°F)

Item	Symbol	C×R10 R type		C×R10 C type	C×R5 type	Remarks
		AQY221R6T	AQY221R2T	AQY221N2T	AQY221N3T	
Input side	LED forward current	50 mA				
	LED reverse voltage	5 V				
	Peak forward current	1 A				f = 100 Hz, Duty factor = 0.1%
	Power dissipation	75 mW				
Output side	Load voltage (peak AC)	30 V	40 V	40 V	25 V	
	Continuous load current	0.8 A	0.25 A	0.12 A	0.15 A	Peak AC, DC
	Peak load current	1.5 A	0.75 A	–	–	100 ms (1shot), V _L = DC
	Power dissipation	250 mW				
Total power dissipation	P _T	300 mW				
I/O isolation voltage	V _{iso}	200 V AC				
Operating temperature	T _{opr}	–40°C to +85°C –40°F to +185°F				Non-condensing at low temperatures
Storage temperature	T _{stg}	–40°C to +100°C –40°F to +212°F				

2. Electrical characteristics (Ambient temperature: 25°C 77°F)

Item	Symbol	C×R10 R type		C×R10 C type	C×R5 type	Condition		
		AQY221R6T	AQY221R2T	AQY221N2T	AQY221N3T			
Input	LED operate current	Typical	0.5 mA		0.7 mA	AQY221R6T: I _L = 100 mA AQY221R2T: I _L = 250 mA AQY221N2T: I _L = 80 mA AQY221N3T: I _L = 80 mA		
		Maximum	3 mA					
	LED turn off current	Minimum	0.1 mA		0.2 mA			
		Typical	0.4 mA		0.6 mA			
LED dropout voltage	Typical	1.14 V (1.35 V at I _F = 50 mA)				I _F = 5 mA		
	Maximum	1.5 V						
Output	On resistance	Typical	0.18 Ω	0.8 Ω	9.5 Ω	5.5 Ω	AQY221R6T: I _F = 5 mA, I _L = 800 mA AQY221R2T: I _F = 5 mA, I _L = 250 mA AQY221N2T: I _F = 5 mA, I _L = 80 mA AQY221N3T: I _F = 5 mA, I _L = 80 mA Within 1 s on time	
		Maximum	0.35 Ω	1.25 Ω	12.5 Ω	7.5 Ω		
	Output capacitance	Typical	37.5 pF	14 pF	1.1 pF			I _F = 0 mA, f = 1 MHz, V _B = 0 V
		Maximum	100 pF	18 pF	1.5 pF			
Off state leakage current	Typical	—	0.02 nA	0.01 nA		I _F = 0 mA, V _L = Max.		
	Maximum	10 nA						
Transfer characteristics	Turn on time*	Typical	0.1 ms		0.01 ms	AQY221R6T: I _F = 5 mA, V _L = 10 V, R _L = 100 Ω AQY221R2T: I _F = 5 mA, V _L = 10 V, R _L = 40 Ω AQY221N2T: I _F = 5 mA, V _L = 10 V, R _L = 125 Ω AQY221N3T: I _F = 5 mA, V _L = 10 V, R _L = 125 Ω		
		Maximum	0.5 ms		0.2 ms			
	Turn off time*	Typical	0.06 ms		0.03 ms			
		Maximum	0.2 ms					
I/O capacitance	Typical	0.4 pF				f = 1 MHz, V _B = 0 V		
	Maximum	1.5 pF						

Notes: 1. Please refer to the "Schematic and Wiring Diagrams" for connection method.

2. Variation possible through combinations of output capacitance and on resistance. For more information, please contact our sales office in your area.

*Turn on/Turn off time

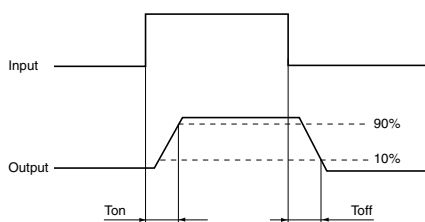

RECOMMENDED OPERATING CONDITIONS

Please obey the following conditions to ensure proper this device operation and resetting.

Item	Symbol	Recommended value	Unit
Input LED current	I _F	5	mA

RF VSSOP 1 Form A C×R10/C×R5 (AQY221○○T)

REFERENCE DATA

1. Load current vs. ambient temperature characteristics

Allowable ambient temperature: -40°C to +85°C
-40°F to +185°F

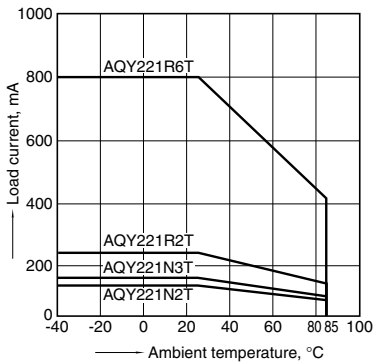

2. Load current vs. Load voltage characteristics

Ambient temperature: 25°C 77°F

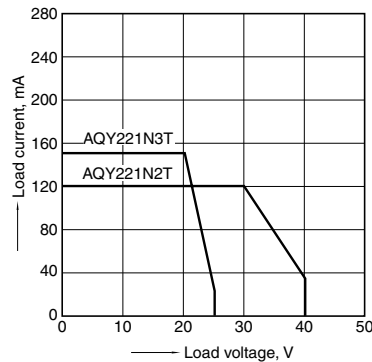

3. On resistance vs. ambient temperature characteristics

Measured portion: between terminals 3 and 4
LED current: 5 mA; Load voltage: 10V (DC)
Continuous load current: 800mA (DC) AQY221R6T, 250mA (DC) AQY221R2T, 80mA (DC) AQY221N2T, AQY221N3T

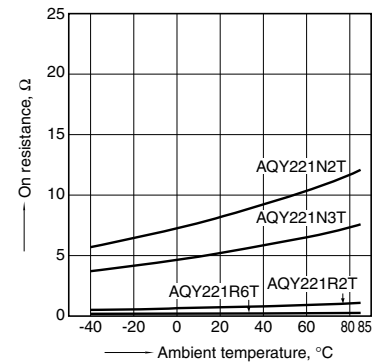

4. Turn on time vs. ambient temperature characteristics

Measured portion: between terminals 3 and 4
LED current: 5 mA; Load voltage: 10V (DC)
Continuous load current: 100mA (DC) AQY221R6T, 250mA (DC) AQY221R2T, 80mA (DC) AQY221N2T, AQY221N3T

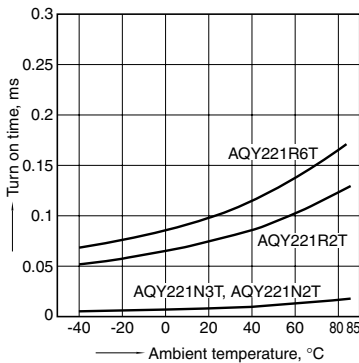

5. Turn off time vs. ambient temperature characteristics

Measured portion: between terminals 3 and 4
LED current: 5 mA; Load voltage: 10V (DC)
Continuous load current: 100mA (DC) AQY221R6T, 250mA (DC) AQY221R2T, 80mA (DC) AQY221N2T, AQY221N3T

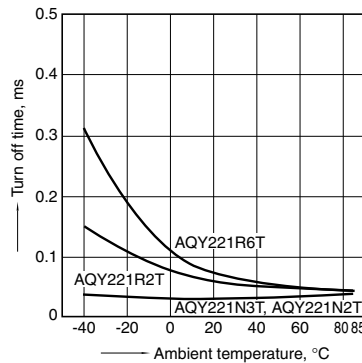

6. LED operate current vs. ambient temperature characteristics

Measured portion: between terminals 3 and 4
Load voltage: 10V (DC)
Continuous load current: 100mA (DC) AQY221R6T, 250mA (DC) AQY221R2T, 80mA (DC) AQY221N2T, AQY221N3T

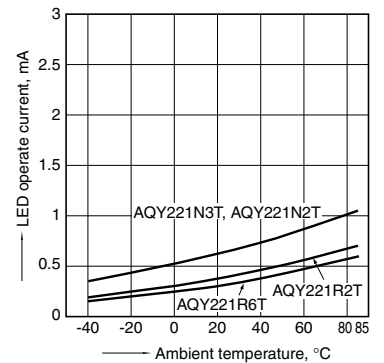

7. LED turn off current vs. ambient temperature characteristics

Measured portion: between terminals 3 and 4
Load voltage: 10V (DC)
Continuous load current: 100mA (DC) AQY221R6T, 250mA (DC) AQY221R2T, 80mA (DC) AQY221N2T, AQY221N3T

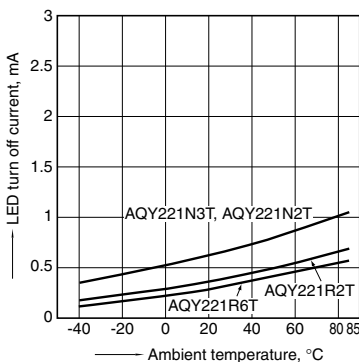

8. LED dropout voltage vs. ambient temperature characteristics

LED current: 5 to 50 mA

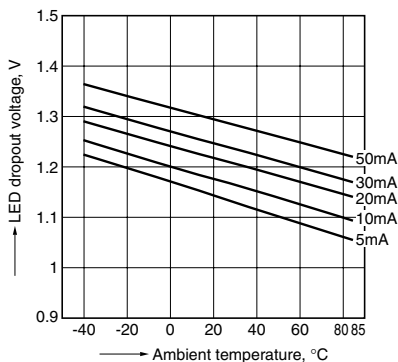

9. Current vs. voltage characteristics of output at MOS portion

Measured portion: between terminals 3 and 4;
Ambient temperature: 25°C 77°F

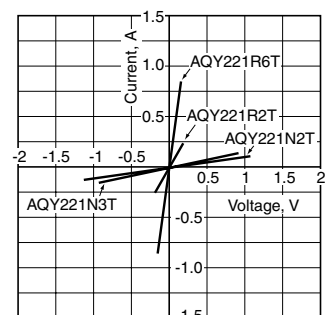

RF VSSOP 1 Form A C×R10/C×R5 (AQY221○○T)

10. Off state leakage current vs. load voltage characteristics

Measured portion: between terminals 3 and 4;
Ambient temperature: 25°C 77°F

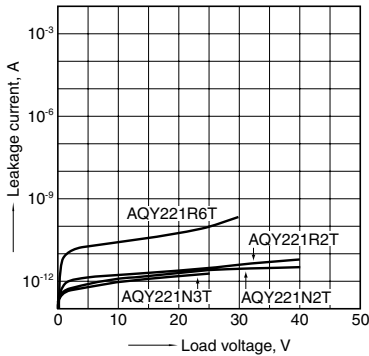

11. Turn on time vs. LED forward current characteristics

Measured portion: between terminals 3 and 4
Load voltage: 10V (DC)
Continuous load current: 100mA (DC) AQY221R6T, 250mA (DC) AQY221R2T, 80mA (DC) AQY221N2T, AQY221N3T
Ambient temperature: 25°C 77°F

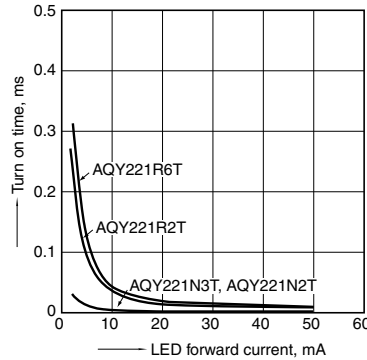

12. Turn off time vs. LED forward current characteristics

Measured portion: between terminals 3 and 4
Load voltage: 10V (DC)
Continuous load current: 100mA (DC) AQY221R6T, 250mA (DC) AQY221R2T, 80mA (DC) AQY221N2T, AQY221N3T
Ambient temperature: 25°C 77°F

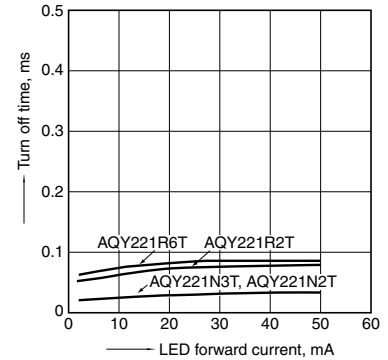

13. Output capacitance vs. applied voltage characteristics

Measured portion: between terminals 3 and 4;
Frequency: 1 MHz (30m Vrms);
Ambient temperature: 25°C 77°F

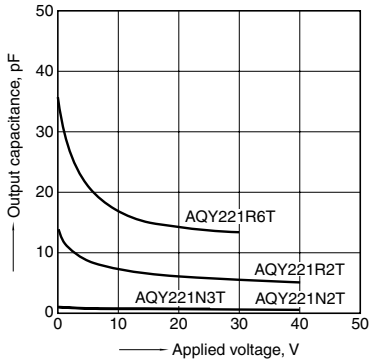

14. Isolation vs. frequency characteristics (50Ω impedance)

Measured portion: between terminals 3 and 4;
Ambient temperature: 25°C 77°F

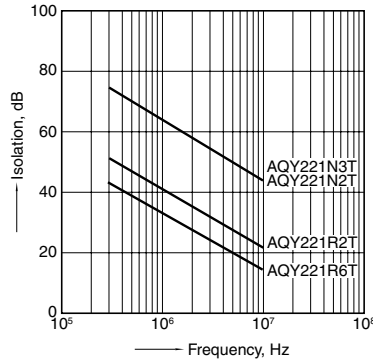

15. Insertion loss vs. frequency characteristics (50Ω impedance)

Measured portion: between terminals 3 and 4;
Ambient temperature: 25°C 77°F

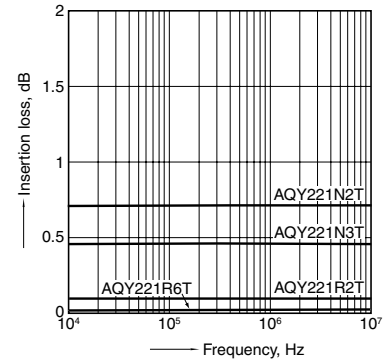

16.-(1) On resistance distribution

Sample: AQY221R6T
Measured portion: between terminals 3 and 4
Continuous load current: 800 mA (DC), n: 50pcs.
Ambient temperature: 25°C 77°F

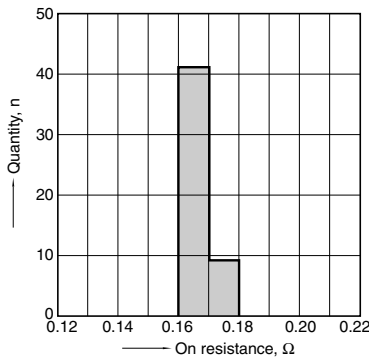

16.-(2) On resistance distribution

Sample: AQY221R2T
Measured portion: between terminals 3 and 4
Continuous load current: 250 mA (DC), n: 50pcs.
Ambient temperature: 25°C 77°F

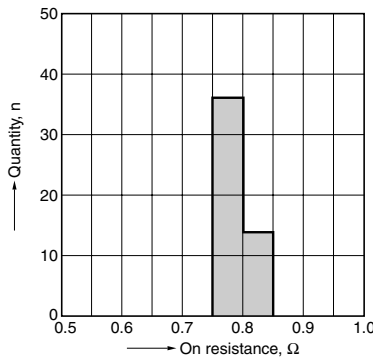

16.-(3) On resistance distribution

Sample: AQY221N2T
Measured portion: between terminals 3 and 4
Continuous load current: 80 mA (DC), n: 50pcs.
Ambient temperature: 25°C 77°F

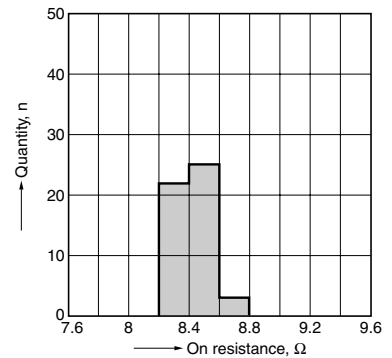

RF VSSOP 1 Form A C×R10/C×R5 (AQY221○○T)

16.-(4) On resistance distribution

Sample: AQY221N3T
 Measured portion: between terminals 3 and 4
 Continuous load current: 80 mA (DC), n: 50pcs.
 Ambient temperature: 25°C 77°F

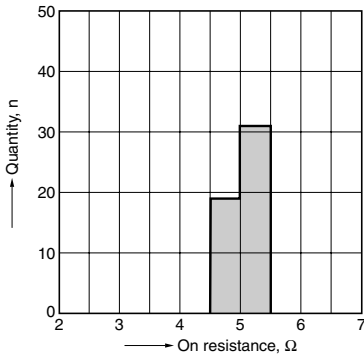

17.-(1) Turn on time distribution

Sample: AQY221R6T
 Load voltage: 10V (DC)
 Continuous load current: 100 mA (DC), n: 50pcs.
 Ambient temperature: 25°C 77°F

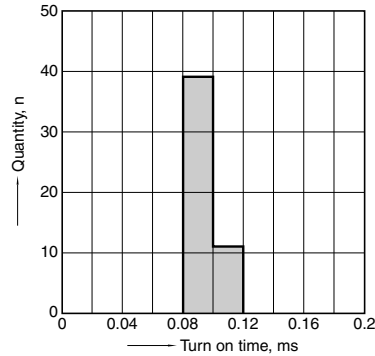

17.-(2) Turn on time distribution

Sample: AQY221R2T
 Load voltage: 10V (DC)
 Continuous load current: 250 mA (DC), n: 50pcs.
 Ambient temperature: 25°C 77°F

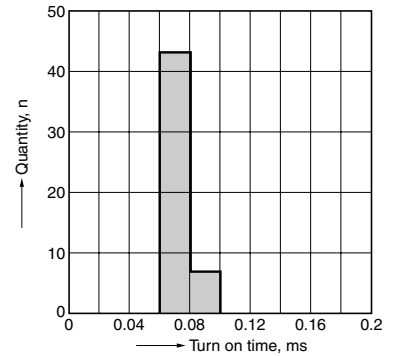

17.-(3) Turn on time distribution

Sample: AQY221N2T
 Load voltage: 10V (DC)
 Continuous load current: 80 mA (DC), n: 50pcs.
 Ambient temperature: 25°C 77°F

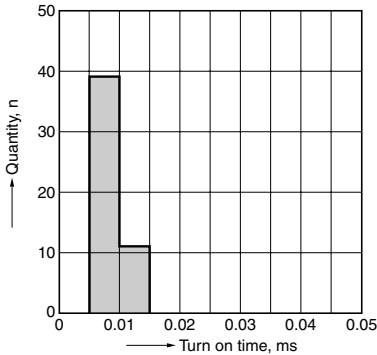

17.-(4) Turn on time distribution

Sample: AQY221N3T
 Load voltage: 10V (DC)
 Continuous load current: 80 mA (DC), n: 50pcs.
 Ambient temperature: 25°C 77°F

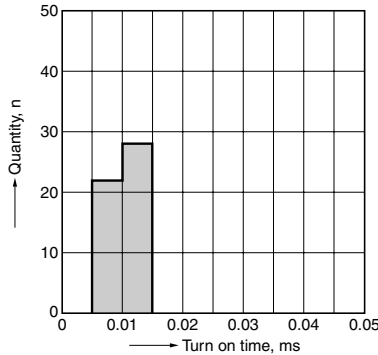

18.-(1) Turn off time distribution

Sample: AQY221R6T
 Load voltage: 10V (DC)
 Continuous load current: 100 mA (DC), n: 50pcs.
 Ambient temperature: 25°C 77°F

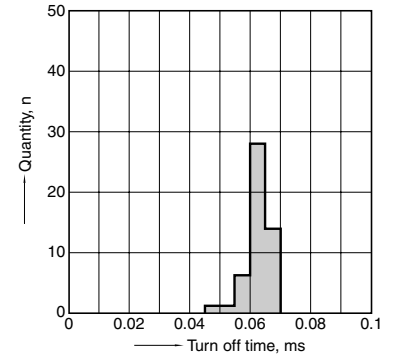

18.-(2) Turn off time distribution

Sample: AQY221R2T
 Load voltage: 10V (DC)
 Continuous load current: 250 mA (DC), n: 50pcs.
 Ambient temperature: 25°C 77°F

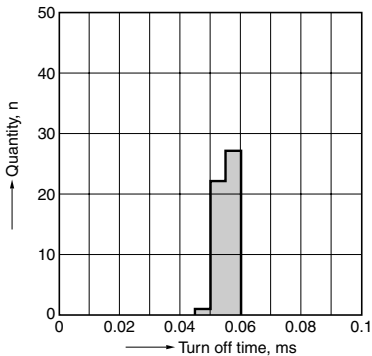

18.-(3) Turn off time distribution

Sample: AQY221N2T
 Load voltage: 10V (DC)
 Continuous load current: 80 mA (DC), n: 50pcs.
 Ambient temperature: 25°C 77°F

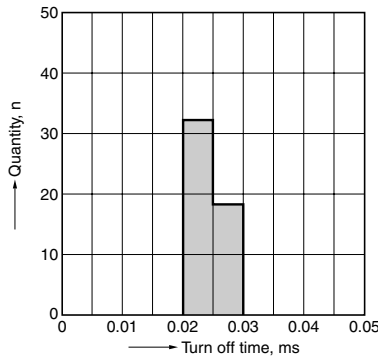

18.-(4) Turn off time distribution

Sample: AQY221N3T
 Load voltage: 10V (DC)
 Continuous load current: 80 mA (DC), n: 50pcs.
 Ambient temperature: 25°C 77°F

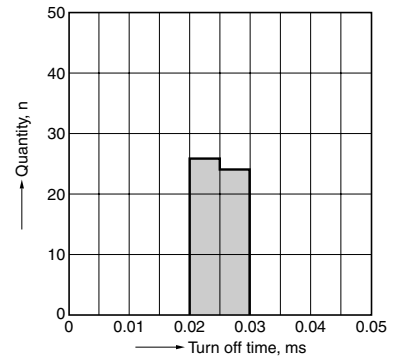

19.-(1) LED operate current distribution

Sample: AQY221R6T
 Load voltage: 10V (DC)
 Continuous load current: 100 mA (DC), n: 50pcs.
 Ambient temperature: 25°C 77°F

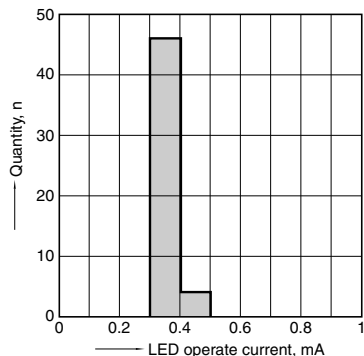

19.-(2) LED operate current distribution

Sample: AQY221R2T
 Load voltage: 10V (DC)
 Continuous load current: 250 mA (DC), n: 50pcs.
 Ambient temperature: 25°C 77°F

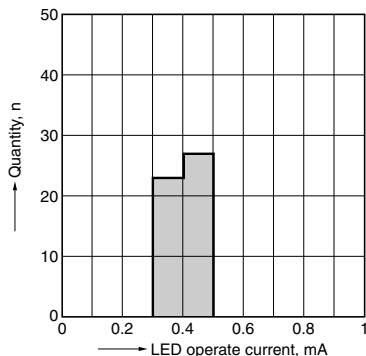

19.-(3) LED operate current distribution

Sample: AQY221N2T
 Load voltage: 10V (DC)
 Continuous load current: 80 mA (DC), n: 50pcs.
 Ambient temperature: 25°C 77°F

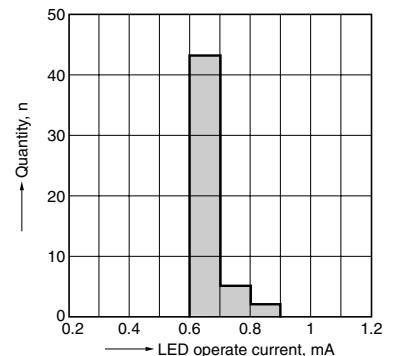

RF VSSOP 1 Form A C×R10/C×R5 (AQY221○OT)

19.-(4) LED operate current distribution

Sample: AQY221N3T

Load voltage: 10V (DC)

Continuous load current: 80 mA (DC), n: 50pcs.

Ambient temperature: 25°C 77°F

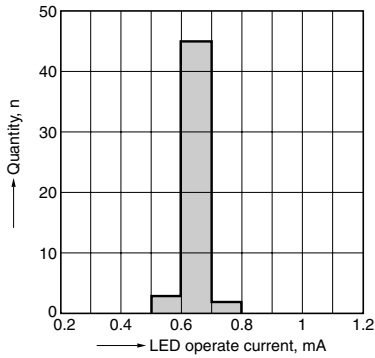

DIMENSIONS (mm inch)

The CAD data of the products with a **CAD Data** mark can be downloaded from: <http://industrial.panasonic.com/ac/e/>

CAD Data



External dimensions

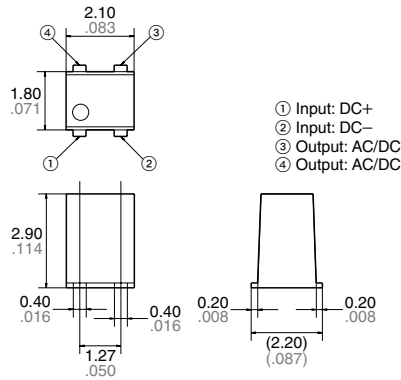

Recommended mounting pad (Top view)

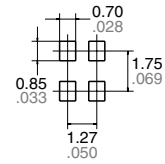

Tolerance: $\pm 0.1 \pm .004$

General tolerance: $\pm 0.1 \pm .004$

SCHEMATIC AND WIRING DIAGRAMS

E_1 : Power source at input side, I_F : LED forward current, V_L : Load voltage, I_L : Load current

Schematic	Output configuration	Load	Connection	Wiring diagram
	1 Form A	AC/DC	—	

单击下面可查看定价，库存，交付和生命周期等信息

[>>Panasonic\(松下\)](#)