

Panasonic

ideas for life

Image Processing Device
MICRO-IMAGECHECKER

AX40



Advanced image processing
with color handling capability.

Image processing with advanced functions that's easy to use.

The AX40 inherits image processing technology built up over many years and know-how derived from hands-on experience in the field. Even more important, it is designed for the kind of performance requirements demanded by our customers. Combining ease of use with sophisticated functions, we have created an image processing device that reaches a new level of perfection.

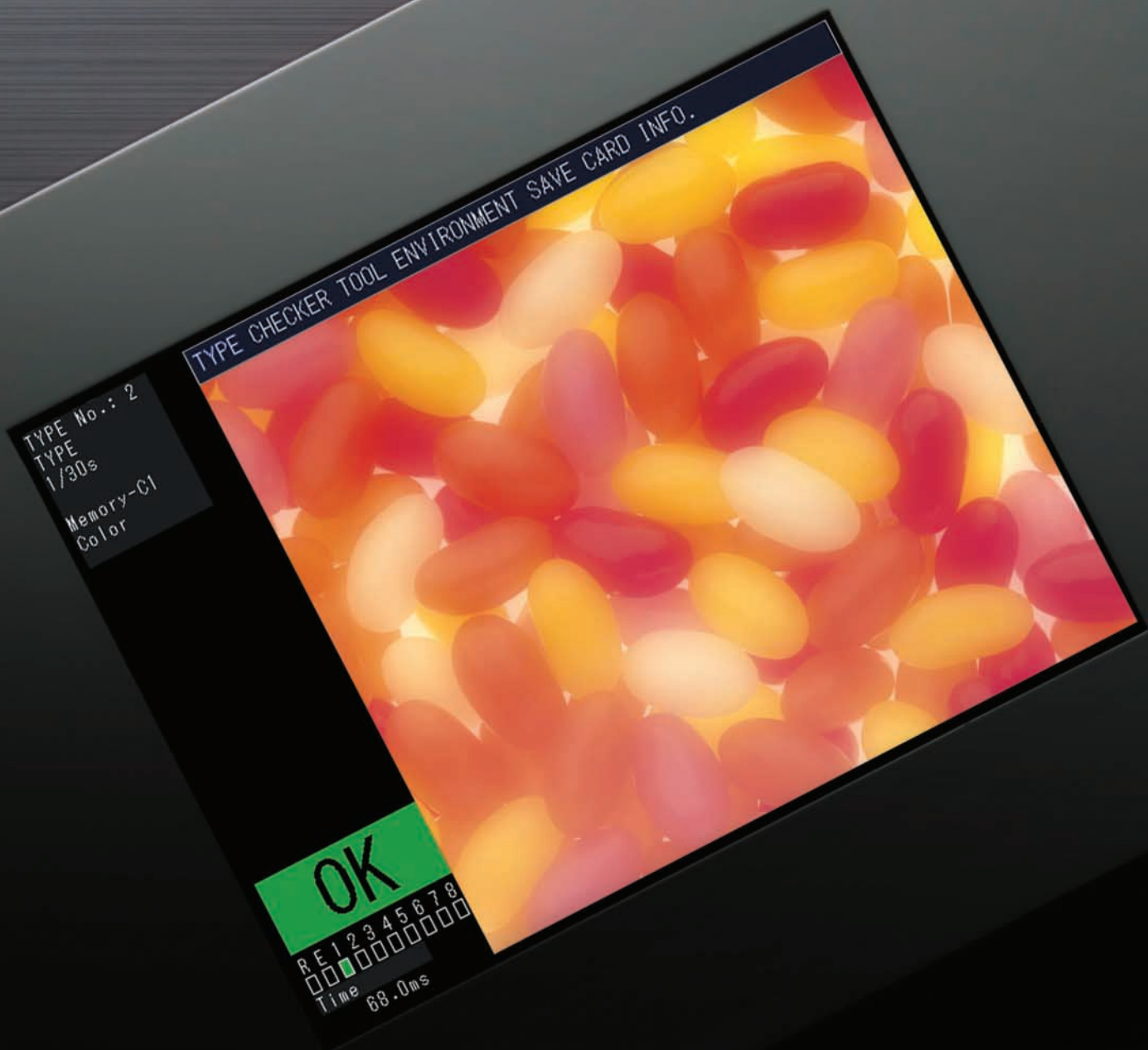

**Color images are displayed at high accuracy during inspection
and both color and gradation are processed.
The AX40 offers easy-to-grasp visual comprehension.**

[Functions]

Fully featured with basic functions such as 360° contour matching, smart matching, and versatile rotation and positional adjustment.

[Setting and Operation]

Maintenance and initial setup support functions included and an easy-to-use operation menu.

Interface

Operator stress is reduced thanks to a high-speed memory slot, high-speed Ethernet (100BASE-TX), and software tools.

MICRO-IMAGECHECKER AX40



Features

Versatile image processing that enables gray scale and color processing. A world first!

Differentiation processing is possible in addition to color and gray scale processing and binarization. High precision image processing means you can use it in a wide range of applications.



Full color



Gray scale



Gray scale differentiation



Color extraction



Binary



Binary differentiation

Verify images on a beautiful color monitor. View two images simultaneously. A world first!

The AX40 uses a dedicated LCD VGA color monitor. Visual clarity is in a league apart from conventional NTSC monitors. Judgment results are displayed large and in color, which makes them easier to see. A font consisting of 18-dot characters is used, so even Japanese kana and kanji characters can be displayed.



Simultaneous image display from two cameras
(This shows an image processed with gray scale and binary differentiation.)



360° contour matching

A world first!

By calculating contour lines and judging, stable positional detection is possible even for hidden, overlapped objects that have been difficult to detect up to now. Thanks to this, better yields are achieved.

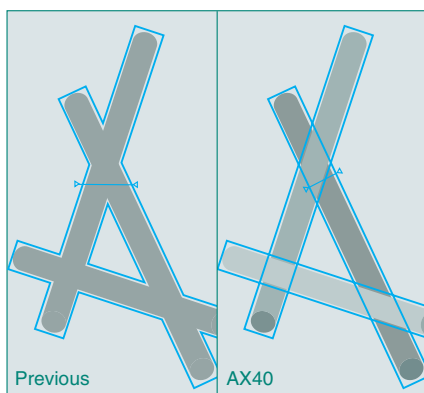

Smart matching

A world first!

Gray scale matching makes sub-pixel positional detection possible. Furthermore, shape inspection, such as for the detection of chipped objects, can be carried out simultaneously with the gray scale difference processing function.

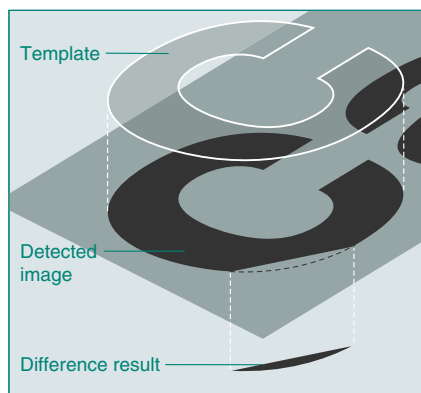

Numerical calculation/ judgment output

Top class

The computation function, which has been troublesome up to now, now supports Japanese, so settings can be easily made, even by beginners to image processing. Also, operation has become even easier thanks to the ability to set both numerical calculation and judgment output on the same screen.

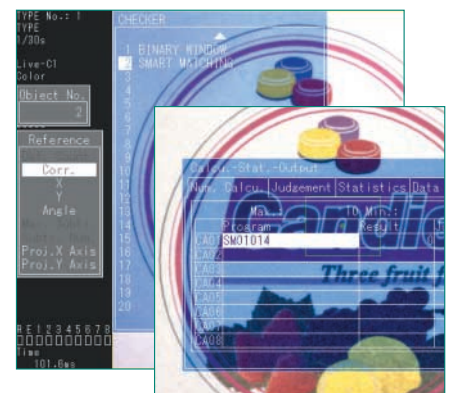

Versatile rotational and positional adjustment

Top class

Highly accurate and reliable inspection is realized by automatically adjusting object orientation and stop position deviation. Since adjustment is done using gray scale data, the AX40 shows its strength when it comes to changes in brightness. Complicated adjustments are possible because of the priority adjustment function.

Multiple adjustment

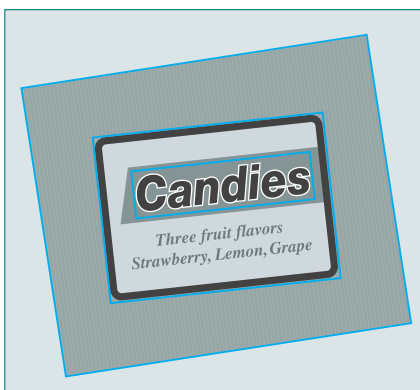

- Positional adjustment
- Rotational adjustment
- Multiple adjustment
- Priority adjustment

Reliable positional adjustment by filter processing

In order to boost rotational position accuracy, filter processing is used to realize stable image processing even for images containing much noise.

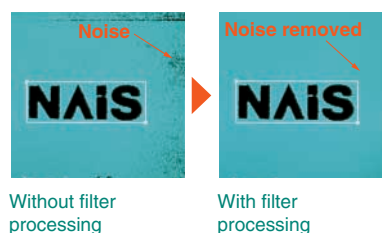

Mask

The shape of the inspection area can be set to match particular targets. Also, mask area settings can also be combined so that efficient inspection can be carried out just for a required part.



Color tone diagram

Fine adjustment for color inspection is possible. Even when colors resemble each other, the target color alone can be extracted to enable highly accurate inspection.

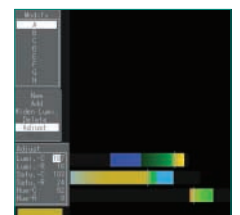

*As of October 2003 (MEW data)

Settings, operation, and applications

Easy operation

Setting is easy using the operation menus which are designed to be easy to understand. Basic keypad operation, too, only requires you to align the cursor with the menu and press the Enter key.



Large capacity memory NEW

Internal memory capacity has been increased. Convenient for multi-product production, the number of templates that can be stored in the unit is three times more than previous.* Templates can, of course, be saved to CompactFlash cards.

*Compared to A210

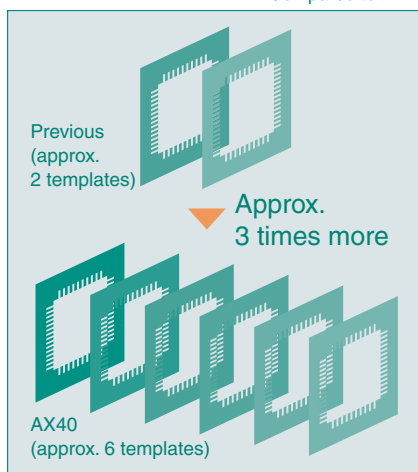

Image storage NEW

With the calendar function, the date of defect and the number of inspections can be added to saved color images. This is useful for post verification (checking a defective product against a saved image) and for analyzing defect tendencies.



Global support (English/Japanese switchable and CE compliant)

Taking into consideration that equipment might be shipped overseas, the display can be switched between Japanese and English. The controller and dedicated color cameras are standardized items, which are CE compliant.

Setting help

This function sets the focus and adjusts the aperture, tasks that used to rely on human judgment, to values that are ideal for image inspection. This reduces setting variation when setting up multiple devices.

Movement all at once

Checkers that have been set can be moved all at once. This is useful for fine adjustment when setting cameras up again. It is also convenient when deploying product type data that have been set on another device.

Security

The AX40 has a security function, which requires password verification to safeguard setting data.

Inspection mode

The AX40 is equipped with a variety of inspection modes such as positional adjustment, rotational adjustment, gray scale and binarization, to support a wide variety of inspection needs.

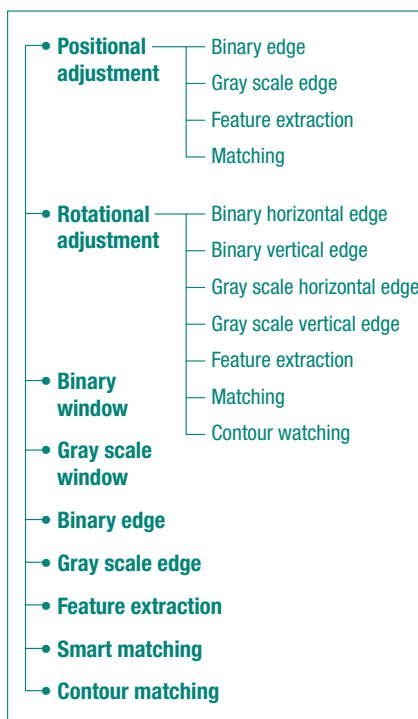

Applications

The AX40 can be used for a wide range of applications, such as presence, color extraction, area, and dimensional inspection.

- Part dimension inspection
- Part direction inspection
- Printed date inspection
- Serial number inspection
- Product nameplate label inspection
- Remote controller switch printing inspection
- Logo letter printing inspection
- Cap tightness inspection
- Flat cable width inspection
- Label position inspection
- Cap color inspection
- Debris/dirt on parts inspection
- 7-segment illumination inspection
- Cupped food content inspection
- Substrate positioning inspection
- Metal parts picking inspection
- Other applications

Data monitor

Original function

Up to 50 inspection results are displayed on the monitor in chart form for operator verification. Also, threshold adjustment (upper and lower limit values) can be changed on the data monitor without entering them in the setting menu.



Statistical support

Original function

Data can be tracked such as maximum value, minimum value, average value, and number of NG (no-go) results. Verification is possible of maximum, minimum, average and other OK judgment values, which is useful as a guide for making upper and lower limit settings.

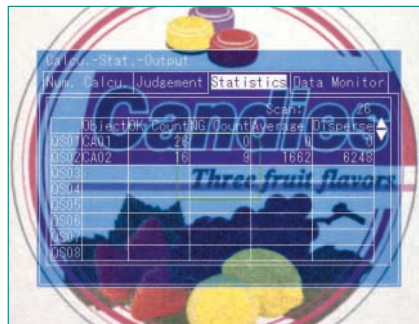

Print screen

In-operation displays or displays when making settings can be saved as bitmaps into a memory card. This is convenient for creating documents or for verifying previously shot images.



AXTOOL Vision Support Tool fills out peripheral lineup!

Original function

The new AXTOOL Vision Support Tool is packed with handier functions than ever. A high-speed interface (100Base-Tx) provides the functions suited to your application.

(Optional products)

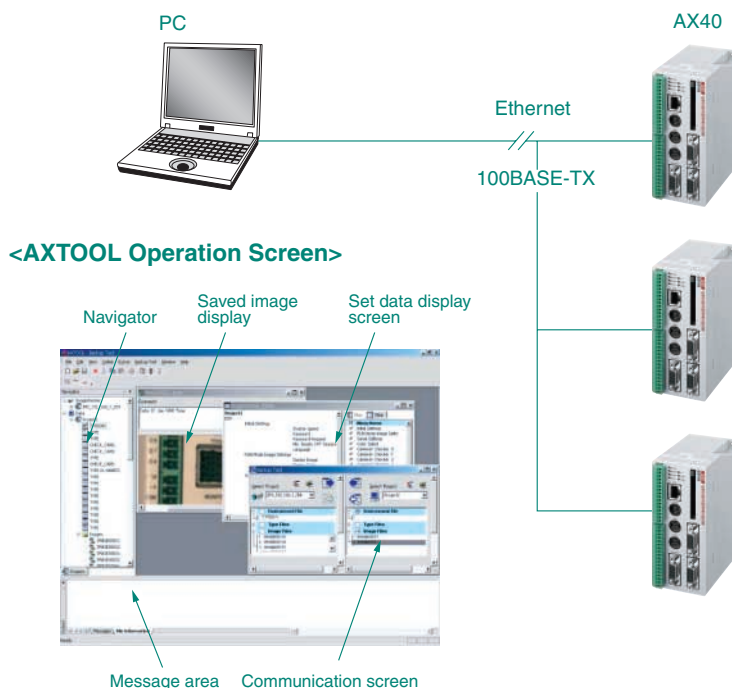

1. Backup/restore image and set data
2. Copy/move/delete image and set data
3. Check saved images on a PC
4. Save set data as CSV document:
Can be edited in Excel

System configuration

CompactFlash and Ethernet

Ethernet

AX40s can be connected to a LAN using high-speed Ethernet (100BASE-TX) to meet various application requirements. Measurement data during operation can be transmitted at high speed to a PC. Also, the inspection status of multiple AX40s can be monitored from a single PC. Image backups are also easy thanks to this high-speed interface.

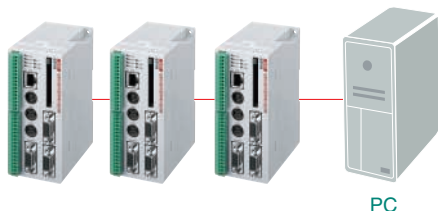

CompactFlash storage

Backup and restoration of setting data and saved images are possible. Also, up to 512 MB of measurement data can be directly written to a CompactFlash card, even during operation. Add power by using spreadsheet software such as Excel to interpret data and analyze trends.



* Backed up image data can be used as regular bitmap files on a PC.

Keypad operation

The amazingly easy-to-operate keypad, which resembles the feel of a game and which was popular in the A series, has been inherited by the AX40.



DIN rail installation

At the rear, one touch is all that's required for DIN rail installation.



PLC link function

Using the RS232C port, communicate easily with external devices such as PLCs! Without programming, connect using our own PLC protocol or connect to the PLCs of other makers.



Two-camera connection

Up to two dedicated color cameras can be connected.



Color monitor

Supports a dedicated 6.5 inch LCD VGA color monitor.



Dimensions (Unit: mm inch)

● Main unit (Controller)
ANMX40

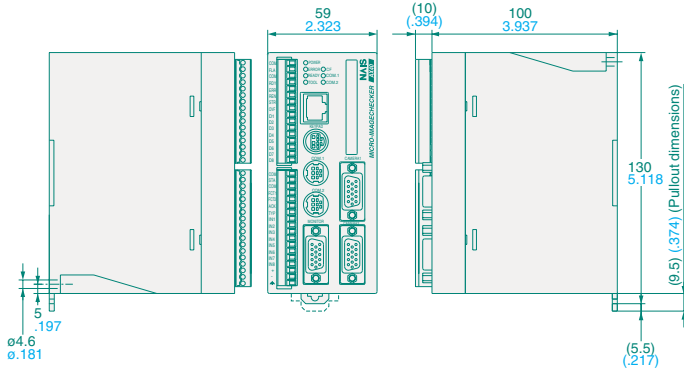

● Operation keypad
ANM8520

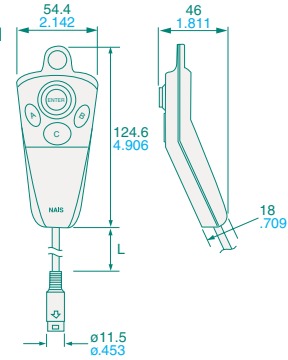

● Keypad cable
(VGA monitor with keypad connector
and Controller connection)
ANMX8333

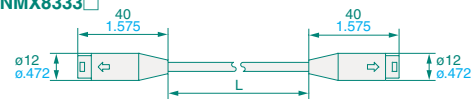

● Dedicated color camera: C mount
ANMX8310

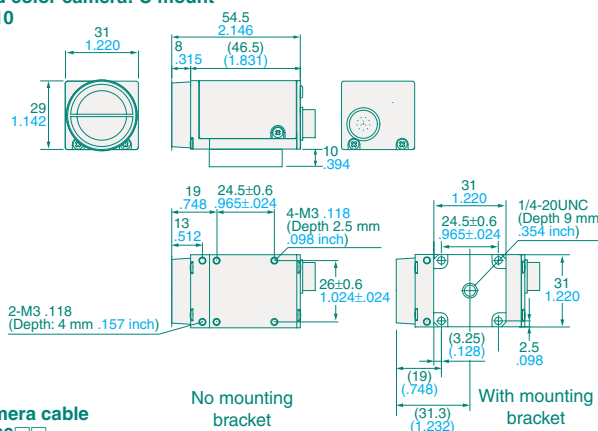

● Color camera cable
ANMX8330

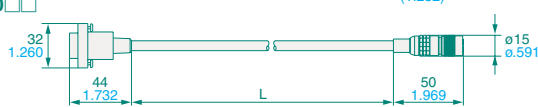

● Lens

Mounting screw (lenses with lock only)

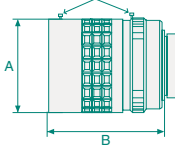

C mount lens	f	A	B
ANB842L	f=6.5 .256	ø48 ø1.890	42 1.654
ANB843L	f=8.5 .335	ø42 ø1.654	40 1.575
ANB845NL	f=16 .630	ø30 ø1.181	33 1.299
ANB846NL	f=25 .984	ø30 ø1.181	37.3 1.469
ANB847L	f=50 1.969	ø48 ø1.890	48 1.890
ANM88161	f=16 .630	ø30.5 ø1.201	25 .984
ANM88251	f=25 .984	ø30.5 ø1.201	25.5 1.004
ANM8850	f=50 1.969	ø27.5 ø1.083	38.5 1.516
ANM88501	f=50 1.969	ø30.5 ø1.201	38.5 1.516

● Color LCD VGA monitor
ANMX8300

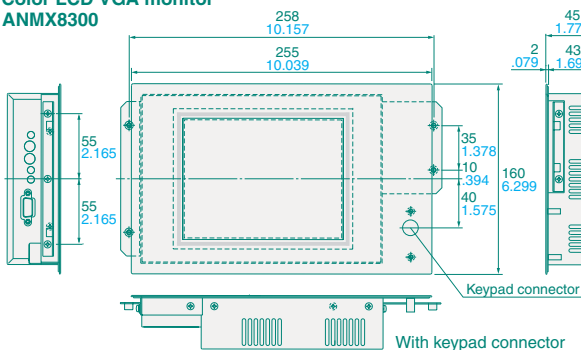

ANMX8301

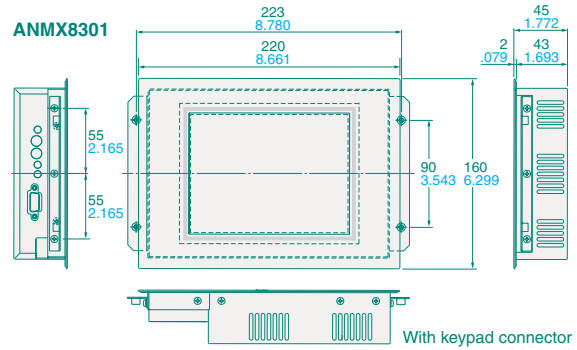

● VGA monitor cable
ANMX8331

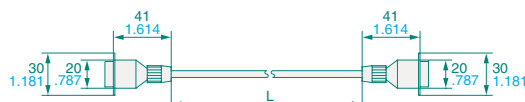

Product Numbers and Specifications

Table of Product Numbers

Product name	Specification	Part No.
AX40 Series Controller	NPN output; Japanese/English switchover (No manual)	ANMX401
	NPN output; English/Japanese switchover (English manual)	ANMX402
	PhotoMOS output; English/Japanese switchover (No manual)	ANMX403
	PhotoMOS output; German/English switchover (No manual)	ANMX404
	PhotoMOS output; French/English switchover (No manual)	ANMX405
	PhotoMOS output; Spanish/English switchover (No manual)	ANMX406
	PhotoMOS output; Italy/English switchover (No manual)	ANMX407
	NPN output; Chinese/English switchover (English manual)	ANMX409
Color camera	Random color camera	ANMX8310
Color camera cable	Camera cable: 3 m	ANMX833003*
	Camera cable: 5 m	ANMX833005*
	Camera cable: 10 m	ANMX833010*
	Camera cable: 15 m	ANMX833015*
	Camera cable: 20 m	ANMX833020*
VGA monitor	With keypad connector	ANMX8300
	No keypad connector	ANMX8301
Product set for installation on main unit	With keypad connector Mounting brackets (ANMX835)/ Monitor cable: 0.5 m/Keypad cable: 0.5 m	ANMX8302
	Without keypad connector Mounting brackets (ANMX835)/Monitor cable: 0.5 m	ANMX8303
Mounting brackets for installation of VGA monitor on controller	Brackets for mounting VGA monitor on the controller	ANMX835
VGA monitor cable	Monitor cable length: 0.5 m (dedicated for all-in-one mounting)	ANMX83310
	Monitor cable length: 1 m	ANMX83311
	Monitor cable length: 2m	ANMX83312
	Monitor cable length: 3m	ANMX83313
Keypad cable (VGA monitor with keypad connector and Controller connection)	Cable length: 0.5 m	ANMX83330
	Cable length: 1 m	ANMX83331
	Cable length: 2 m	ANMX83332
	Cable length: 3 m	ANMX83333
C mount lens	f6.5 C mount lens with lock	ANB842L
	f8.5 C mount lens with lock	ANB843L
	f16 C mount compact lens with lock	ANB845NL
	f16 C mount super-compact lens with lock	ANM88161
	f25 C mount compact lens with lock	ANB846NL
	f25 C mount super-compact lens with lock	ANM88251
	f50 C mount lens with lock	ANB847L
	f50 C mount compact lens f50 C mount compact lens with lock	ANM8850 ANM88501
Adapter ring	5 mm adapter ring	ANB84805
	(0.5/1/5/10/20/40 mm) adapter ring	ANB848
Operation keypad	With 2 m cable	ANM85202
	With 3 m cable	ANM85203
	With 2 m cable: CE	ANM85202CE
	With 3 m cable: CE	ANM85203CE
COM port connecting cable	COM port and PC (D-SUB: 9pins) connection; 3m	ANM81103
	COM port and PLC (discrete-wire cable) connection; 3m	ANM81303
Vision Support Tool AXTOOL	English version	ANMX8321

* When ordering CE products, please add "CE" to the end of the product number.

Functional specification

Product name	Specification
CPU	32-bit RISC CPU
Settings data storage capacity	Approx. 4 MB
Frame memory	512 x 480 (pixels)
Operation environment	Menu selection using dedicated keypad (Japanese/English switchable)
	Menu selection using key emulation serial commands
Monitor display	Full color VGA/gray scale image/binary image/extraction color + brightness image through
	Memory + data display area
	Two-screen compressed display
Connected camera	Random color camera (progressive)
Number of connected cameras	2
	When 1 camera is connected 2 processes can be selected among gray scale, differentiation and color extraction processing. When 2 cameras are connected, gray scale, differentiation or color extraction can be selected for each camera.
Process	Gray scale processing
	Differentiation processing
	Color extraction processing
Number of product types	16
Inspection functions	Max 99/product type
Position adjustment function	99/product type positional adjustment function (multiple adjustment possible) Binary edge (with priority designation) Gray scale edge (with priority designation) *Only when gray scale and differentiation processing are selected. Feature extraction (mask setting possible) Matching (template mask setting possible) *Only when gray scale and differentiation processing is selected.
	Rotation adjustment function
Binary window	Max. 99/product type (multiple adjustment possible) Horizontal binary edge Vertical binary edge Horizontal gray scale edge *Only when gray scale and differentiation processing are selected. Vertical gray scale edge *Only when gray scale and differentiation processing are selected. Feature extraction (mask setting possible) Matching (template mask setting possible) *Only when gradation and differentiation processing are selected. Contour matching (±180 degrees)
	Binary edge
Feature extraction	Max. 99/product type Shape: rectangle/polygon (3 to 16 points)/ellipse; 16 mask shape: rectangle/polygon/ellipse; 16 white (extraction)/black (no extraction) selectable Expansion and contraction filter Judgement = surface value Output = surface value
	Max. 99/product type Shape = line/plane Selection possible among white (extraction) → black (no extraction) and white (extraction) → black (no extraction) Depth/width designation function Judgement = detection/no detection Output = edge detection coordinate
Feature extraction	Max. 99/product type Shape: rectangle/polygon (3 to 16 points)/ellipse; mask shape: rectangle/polygon/ellipse; 16 white (extraction)/black (no extraction) selectable Expansion and contraction filter Judgment: number of detections Output: number of detections/barycentric coordinate/area value/ projection width/main axis angle/circumference

Product name		Specification
Inspection function	Gray scale window	Max. 99/product type *Only when gray scale and differential processing are selected. Shape: rectangle/polygon (3 to 16 points)/ellipse; mask shape: rectangle/polygon/ellipse; 16 Upper and lower brightness levels can be set. Judgment: average gray scale value Output: average gray scale value
	Gray scale edge	Max 99/product type *Only when gray scale and differentiation processing are selected. Shape: line/plane Projection/individual scan Light to dark; dark to light; designation of both possible Edge; leading edge and trailing edge; maximum derivative; multiple Depth/width designation function Judgment: number of detections Output: number of detections/edge detection coordinate
	Smart matching	Max. 99/product type *Only when gray scale and differentiation processing is selected. Shape: rectangle template; mask shape: rectangle/polygon/ellipse; 16 Difference setting possible Judgment: number of detections and number of differences Output: number of detections/detected coordinates/detected angle/correlation value/difference area value/number of differences
	Contour matching	Max. 2/product type Shape: rectangle ±180 degree detection possible Judgment: correlation Output: detected coordinate/detected angle/correlation
Numerical computation	Max. 99/product type 4-operation computation/ $\sqrt{\quad}$ /arc tangent/distance between 2 points/case arc/Sin/Cos/absolute value of difference Possible to quote output of each inspection function. Reference previous data.	
Judgment output	Max. 99/product type NOT/AND/OR/XOR/case arc Image storage condition setting/general judgment condition setting/output setting	
Data monitor	Max. 50/product type Data can be displayed in chart format when running. Title input or numerical calculation results, judgment output results, statistical results and product numbers can be quoted. External output settings of quoted items Upper and lower limit values of numerical computations can be changed from the chart while running.	
Statistics	Max. 16 per product type Numerical calculation and judgment output results can be quoted. The following can be calculated: number of scans, number of OK results, number NG (no-go) results, OK average, OK dispersion, max. value, min. value, and range. Quoting is possible to the data monitor.	
Operation data	Max. 4/environment Quoting to numerical computation is possible. Comment input is possible	
Marker	Max. 8/product type Graphic display on screen while running (rectangle/circle and ellipse/straight lines)	

Product name		Specification
External I/O	Serial	RS232C: 2 channels (max. speed 115,200 bps) Input: start/product type switching/camera display switching/template re-registration/CompactFlash restore/reference of numerical computation upper and lower limits and changes/data storage/statistical initialization/reference and change of binarization level/reference and change of gray scale edge threshold value Output: judgment output and quoted data from data monitor Computer link support: Matsushita Electric Works' FP series and Mitsubishi's A, Q and FX series/Omron's C, CV and CS1 series/Allen-Bradley's SLC500 series
	Parallel	Input: 13 points; output: 14 points; removable screw-down terminal block Input: start, product type switching, camera display switching, template re-registration Output: ready/error/flash/judgment output data
	Ethernet	Ethernet: 1 channel Output: judgment output, data quoted from data monitor (TCP/IP) Setting data and image backup, restore, documentation of setting data (AXTOOL)
	CompactFlash	Compact flash: 1 slot Output: judgment output and data quoted from data monitor (text file) Setting data, image backup/restore, screen hard copy
Other	Display function	Transparent menu Output status monitor Reference coordinate display (quoting to numerical computation possible) Numerical setting of set color and center color display Checkers with NG (no-go) results displayed with different color
	Movement at once	Checker movement all at once is possible for each position and rotation adjustment group.
	Screen storage	Max. 16 images/camera Each time/storage possible by judgment result Test execution possible with saved images. Display of date saved. Function to keep last image to be saved displayed.
	Setting help	White balance setting Focusing/aperture adjustment (only when gray scale processing is selected) Parallel monitor
	Calendar	Calendar data added to saved images
Password	Password function for moving between setting modes	

Please contact

Panasonic Electric Works Co., Ltd.

Automation Controls Business Unit

■ Head Office: 1048, Kadoma, Kadoma-shi, Osaka 571-8686, Japan

■ Telephone: +81-6-6908-1050 ■ Facsimile: +81-6-6908-5781

panasonic-electric-works.net/ac

Panasonic®

All Rights Reserved © 2010 COPYRIGHT Panasonic Electric Works

单击下面可查看定价，库存，交付和生命周期等信息

[>>Panasonic\(松下\)](#)