



Discontinued: 50 and 54 contacts, Last time buy: October 31, 2011
 Discontinued: 26, 28, 34, 40 and 45 contacts, Last time buy: August 31, 2012

AYF52

Panasonic
 ideas for life

For FPC/FFC	Y5F Series
FPC connectors (0.5mm pitch) Front lock	



RoHS compliant

FEATURES

1. A wide variety of digital equipments
 The 0.5mm pitch, 2.0mm height, and 6.3mm depth are suitable for a variety of digital equipment.

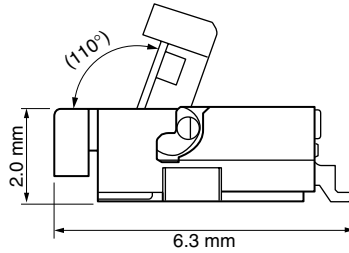

2. Front lock structure with tactile feedback

The front lock structure facilitates FPC connection work.

3. Equipped with soldering terminals for higher mounting strength

APPLICATIONS

Digital equipment, such as PCs, digital TVs, HDDs, car navigation systems, home-use game machines, multifunction fax machines, and security cameras

ORDERING INFORMATION

AYF 5 2 1 5

52: FPC Connector 0.5 mm pitch (Front lock)

Number of contacts (2 digits)

Contact direction
 1: Bottom contact

Surface treatment (Contact portion / Terminal portion)
 5: Au plating/Au flash plating

PRODUCT TYPES

Height	Number of pins	Part number	Packing	
			Inner carton	Outer carton
2.0 mm	26	AYF522615	2,000 pieces	4,000 pieces
	28	AYF522815		
	34	AYF523415		
	40	AYF524015		
	45	AYF524515		
	50	AYF525015		
54	AYF525415			

Note: Order unit;
 For mass production: in 1-inner carton (1-reel) units
 Samples for mounting check: in 50-connector units.
 Samples: Small lot orders are possible. Please contact our sales office.



Discontinued: 50 and 54 contacts, Last time buy: October 31, 2011
 Discontinued: 26, 28, 34, 40 and 45 contacts, Last time buy: August 31, 2012

AYF52

SPECIFICATIONS

1. Characteristics

	Item	Specifications	Conditions
Electrical characteristics	Rated current	0.5A/pin contact	
	Rated voltage	50V AC/DC	
	Insulation resistance	Min. 1,000MΩ (initial)	Using 250V DC megger
	Breakdown voltage	250V AC for 1 min.	No short-circuiting or damage at a detection current of 1 mA when the specified voltage is applied for one minute.
	Contact resistance	Max. 45mΩ	Measurement using HP4338B based on the measurement method specified by JIS C 5402.
Mechanical characteristics	FPC/FFC holding force	Min. 0.2N/pin contacts × pin contacts (initial)	Measurement of the maximum force applied until the inserted compatible FPC is pulled out in the insertion axis direction while the connector lever is closed
	Contact holding force	Min. 1.0N/pin contacts	Measuring the maximum force. As the contact is axially pull out.
	Soldering terminal holding force	Min. 1.0N/pin contacts	Measuring the maximum force. As the soldering terminal is axially pull out.
Environmental characteristics	Ambient temperature	-55°C to +85°C	No freezing at low temperatures. No dew condensation.
	Storage temperature	-55°C to +85°C (product only) -40°C to +50°C (emboss packing)	
	Thermal shock resistance (with FPC/FFC inserted)	5 cycles, contact resistance max. 45mΩ	Sequence 1. -40°C, 30 minutes 2. Normal temperature (+20 to 35°C), 5 to 15 minutes 3. +85°C, 30 minutes 4. Normal temperature (+20 to 35°C), 5 to 15 minutes
	Humidity resistance (with FPC/FFC inserted)	120 hours, insulation resistance min. 500MΩ, contact resistance max. 45mΩ	Bath temperature 40±2°C, humidity 90 to 95% R.H.
	Saltwater spray resistance (with FPC/FFC inserted)	24 hours, contact resistance max. 45mΩ	Bath temperature 35±2°C, saltwater concentration 5±1%
	H ₂ S resistance (with FPC/FFC inserted)	48 hours, contact resistance max. 45mΩ	Bath temperature 40±2°C, gas concentration 3±1 ppm, humidity 75% R.H.
	Soldering heat resistance	Peak temperature: 260°C or less 300°C within 5 sec. 350°C within 3 sec.	Reflow soldering Soldering iron
Lifetime characteristics	Insertion and removal life	30 times	Repeated insertion and removal: min. 10 sec./time
Unit weight		50 pin contact type: 0.51 g	

2. Material and surface treatment

Part name	Material	Surface treatment
Molded portion	Housing: LCP resin Lever: Polyamide resin	—
Contact	Copper alloy	Contact portion; Base: Ni plating, Surface: Au plating Terminal portion; Base: Ni plating, Surface: Au plating
Soldering terminal portion	Copper alloy	Base: Ni plating, Surface: Sn plating

DIMENSIONS (Unit: mm)

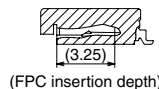
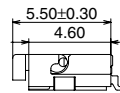
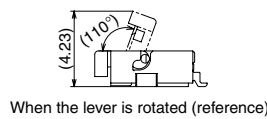
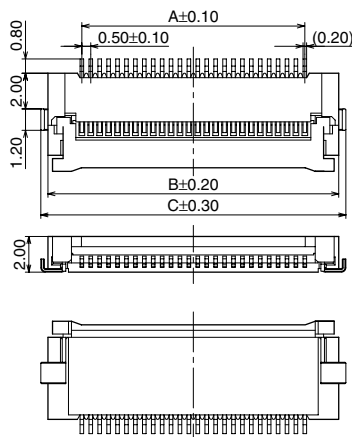

Number of pins/ dimension	A	B	C
26	12.5	16.3	17.1
28	13.5	17.3	18.1
34	16.5	20.3	21.1
40	19.5	23.3	24.1
45	22.0	25.8	26.6
50	24.5	28.3	29.1
54	26.5	30.3	31.1



Discontinued: 50 and 54 contacts, Last time buy: October 31, 2011
 Discontinued: 26, 28, 34, 40 and 45 contacts, Last time buy: August 31, 2012

RECOMMENDED FPC/FFC DIMENSIONS

Surface finish: Au plating

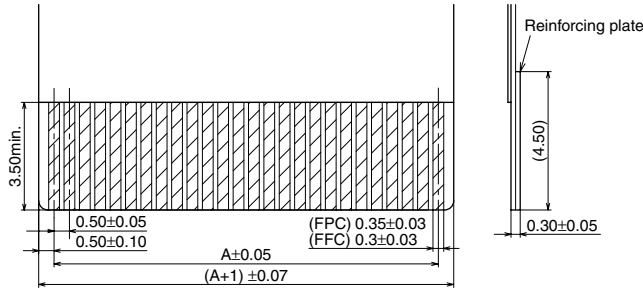

Number of pins/ dimension	A
26	12.5
28	13.5
34	16.5
40	19.5
45	22.0
50	24.5
54	26.5

EMBOSSED TAPE DIMENSIONS (Unit: mm) (Common for respective contact type)

• Specifications for taping

• Specifications for reel

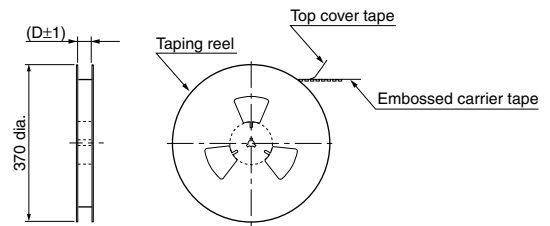
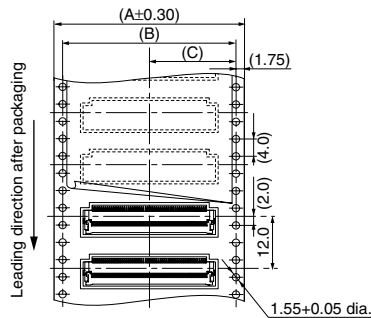

• Dimension table (Unit: mm)

Number of pins	A	B	C	D	Quantity per reel
26, 28 and 34 pin contacts	32.0	28.4	14.2	33.0	2,000
40, 45, 50 and 54 pin contacts	44.0	40.4	20.2	45.0	2,000

• Connector orientation with respect to embossed tape feeding direction

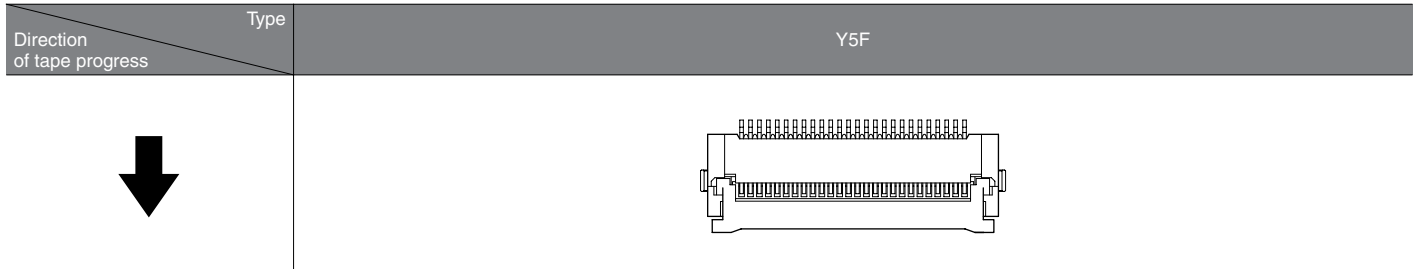

NOTES

1. Recommended PC board pattern

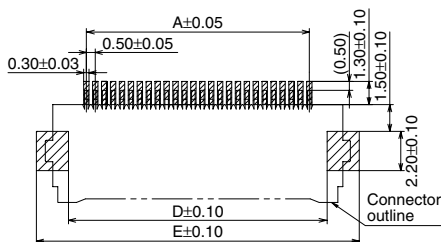

Number of pins/ dimension	A	D	E
26	12.5	14.5	18.1
28	13.5	15.5	19.1
34	16.5	18.5	22.1
40	19.5	21.5	25.1
45	22.0	24.0	27.6
50	24.5	26.5	30.1
54	26.5	28.5	32.1

2. Precautions for insertion/removal of FPC/FFC

When the connector has 40 or more contacts, press both ends of the lever with two fingers to lock the lever. If only the center of the lever is pressed, a lock failure may occur, leading to a continuity failure or connector breakage. When the connector has less than 40 contacts, open/close the lever at its center. A load applied to the lever unevenly or on only one side may deform the lever. Fully open the lever to insert an FPC. Don't further apply an excessive load to the fully opened lever; otherwise, the lever may be deformed.

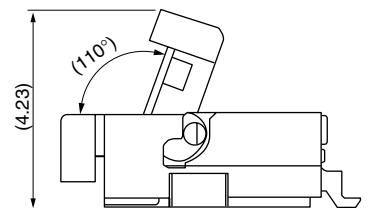

When the lever is half-opened, the cable cannot be inserted. Don't pull out the FPC when the lever is locked; otherwise, this may result in a continuity failure or connector breakage. After an FPC is inserted, carefully handle it so as not to apply excessive stress to the base of the FPC.

Please refer to the latest product specifications when designing your product.

NOTES FOR USING FPC CONNECTORS (Common)

■ PC board design

Design the recommended foot pattern in order to secure the mechanical strength in the soldered areas of the terminal.

■ FPC and equipment design

Design the FPC based with recommended dimensions to ensure the required connector performance.

Due to the FPC size, weight, or the reaction force of the routed FPC.

Carefully check the equipment design and take required measures to prevent the FPC from being removed due to a fall, vibration, or other impact.

■ Connector mounting

Excessive moulder chucking force may deform the molded or metal part of the connector. Consult us in advance if chucking is to be applied.

■ Soldering

1) Manual soldering.

- Due to the connector's low profile, if an excessive amount of solder is applied during manual soldering, the solder may creep up near the contact points, or solder interference may cause imperfect contact.

- Make sure that the soldering iron tip is heated within the temperature and time limits indicated in the specifications.

- Flux from the solder wire may adhere to the contact surfaces during soldering operations. After soldering, carefully check the contact surfaces and clean off any flux before use.

- Be aware that a load applied to the connector terminals while soldering may displace the contact.

- Thoroughly clean the iron tip.

2) Reflow soldering

- Screen-printing is recommended for printing paste solder.

- To determine the relationship between the screen opening area and the PC board foot pattern area, refer to the diagrams in the recommended patterns for PC boards and metal masks when setting.

- Note that excess solder on the terminals prevents complete insertion of the FPC, and that excess solder on the soldering terminals prevents the lever from rotating.

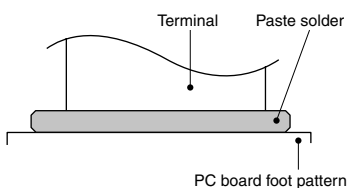

- Screen thickness of 120 μ m is recommended for paste solder printing.
- Consult us when using a screen-printing thickness other than that recommended.
- Depending on the size of the connector being used, self alignment may not be possible. Accordingly, carefully position the terminal with the PC board pattern.
- The recommended reflow temperature profile is given in the figure below

Recommended reflow temperature profile

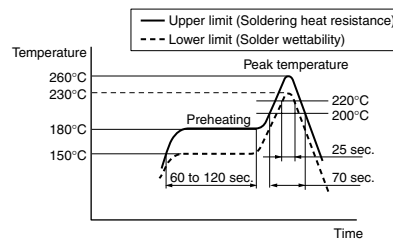

- The temperature is measured on the surface of the PC board near the connector terminal.
- Certain solder and flux types may cause serious solder creeping. Solder and flux characteristics should be taken into consideration when setting the reflow soldering conditions.

- When performing reflow soldering on the back of the PC board after reflow soldering the connector, secure the connector using, for example, an adhesive. (Double reflow soldering on the same side is possible)

3) Reworking on a soldered portion

- Finish reworking in one operation.

- For reworking of the solder bridge, use a soldering iron with a flat tip. Do not add flux, otherwise the flux may creep to the contact parts.

- Use a soldering iron whose tip temperature is within the temperature range specified in the specifications.

■ **Do not drop or handle the connector carelessly. Otherwise, the terminals may become deformed due to excessive force or applied solderability may be during reflow degrade.**

■ **Don't open/close the lever or insert/remove an FPC until the connector is soldered. Forcibly applied external pressure on the terminals can weaken the adherence of the terminals to the molded part or cause the terminals to lose their evenness. In addition, do not insert an FPC into the connector before soldering the connector.**

■ **When cutting or bending the PC board after mounting the connector, be careful that the soldered sections are subjected to excessive forces.**

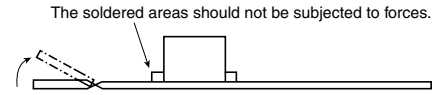

■ Other Notes

When coating the PC board after soldering the connector (to prevent the deterioration of insulation), perform the coating in such a way so that the coating does not get on the connector.

The connectors are not meant to be used for switching.

Please refer to the latest product specifications when designing your product.

单击下面可查看定价，库存，交付和生命周期等信息

[>>Panasonic\(松下\)](#)