

- Electrical construction possible at 100V power.
- The built-in magnet safeguards checking of the facility cover and gate.
- Built-in switch with accurate ON/OFF detection.
- Combination of magnet (support) and limit switch (detection) saves on both construction and space.
- Two types of contact: 1 Form A (ON when gate is closed)
1 Form B (ON when gate is open.)
- The unit case is available in three colors: Yellow, brown, and gray.
- The product comes with three different types of weight sustainability: 1kg, 3kg and 5kg.

PRODUCT TYPE

Product name	Specifications				Part No.
	Contact construction	Case color	Sustainable weight sustainability	Packaging	
Magnelimit 1 Form A	1a (ON when gate is closed)	Yellow	3kg type (29.4N {3kgf}) (Note: 1)	-	AZC11013Y
		Brown		-	AZC11013A
		Gray		-	AZC11013H
Magnelimit 1 Form B	1b (ON when gate is open)	Yellow		-	AZC11113Y
		Brown		-	AZC11113A
		Gray		-	AZC11113H
Options	Metal plate	Metal plate (13mm × 60mm × 1.6mm .512inch × 2.362inch × .063inch)		AZC1801	

Notes:1. The unit comes with an metal plate enclosed.
2. The blister pack type comes with 1 metal plate and 4 screws (2 long, 2 short) enclosed.
3. Weight sustainability also comes in 1kg and 5kg types. Specify when ordering by replacing "3" with "1" for the 1kg type, and "5" for the 5kg type at the end of the part No.

SPECIFICATIONS

1. Ratings

Rated voltage	Load type	Resistance load	Lamp load	Guidance load
125V AC		5A	1.5A	3A
250V AC		5A	-	3A
30V DC		5A	-	1.5A

Notes:1. Inductive load is a minimum 0.4 (AC) and time duration is maximum 7ms (DC).
2. Lamp load has 10 times the inrush current.
3. Minute load ratings: 5mA 6V DC, 1mA 24V DC.

2. Switch operating features

Operating force (O.F.) (N{gf})	3.43 {350} max.
Return force (R.F.) (N{gf})	0.49 {50} min.
Pretravel (P.T.)	1.8mm .071inch max.
Movement differential (M.D.)	0.2 to 0.8
Release position (R.P.)	4.0mm .157inch max.

3. Capabilities overview

Electrical capabilities	Insulation resistance (initial)	Min. 100 \triangleright (measured at 500V DC insulation resistance)
	Voltage resistance	Contact distance: AC 1000V/1 min. (initial) Distance between each pin and uncharged metal parts: AC 2100V/1 min. Distance between each pin and earth: AC 2100V/1 min.
Life	Mechanical life	Min. 100 thousand times (ON/OFF frequency 60 times/min.)
	Electrical life	Min. 50 thousand times (resistance load AC 250V 5A) Min. 30 thousand times (lamp load AC 125V 1.5V) ON/OFF frequency 20 times/min.
Protective capabilities		IP40
Usage conditions	Ambient temperature	-20 to +80°C -4 to 176°F (but not in a frozen environment.)
	Ambient humidity	Max. 95% RH
	Tolerable operating frequency	Mechanical: 60 times/min. Electrical: 20 times/min.
Sustainability (when using the enclosed metal plate)		1kg (9.8N {1kgf}), 3kg (29.4N {3kgf}), 5kg (49N {5kgf})

OUTPUT CIRCUIT DIAGRAM

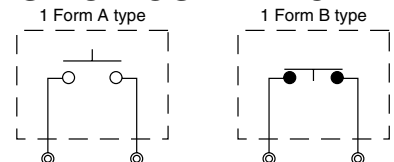

DIMENSIONS

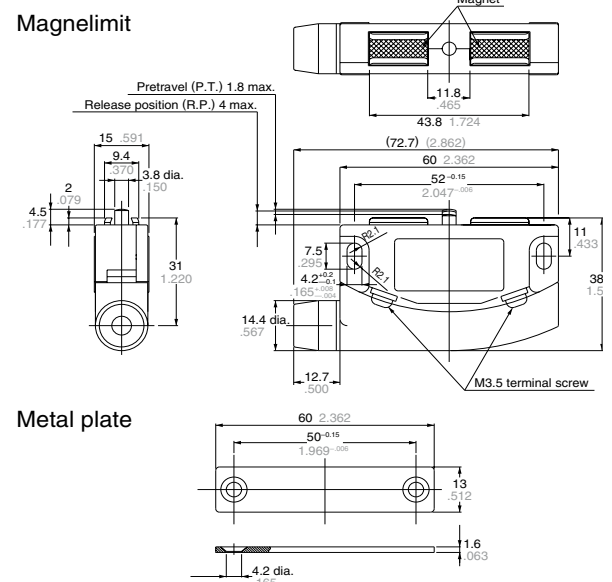

METAL PLATE ATTACHMENT

• Attaching the main unit

- Using an M4 screw, attach firmly remembering to employ a washer, etc. The appropriate torque is 1.18 to 1.47N (12 to 15kg/cm.)
- When moveable parts such as the gate are closed, ensure that the yoke and metal plate are flush with each other.

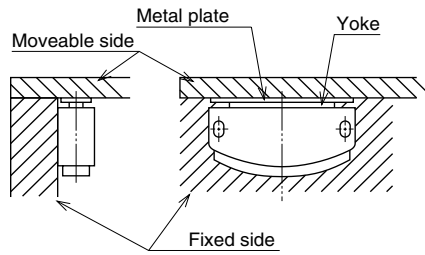

• Attaching the metal plate

- Using an M3 dish screw, attach to the side opposite from the yoke. Pay particular attention that the head of the attached screw does not protrude further than the surface of the metal plate (if using wooden screws, a call of 2.7 is optimum.)
- If the adhesive side is magnetic (metal plate), the adhesion may prove ineffective. Further, since the sustainability varies depending on the board thickness and the surface processing (paint, etc.), it is best to check beforehand.

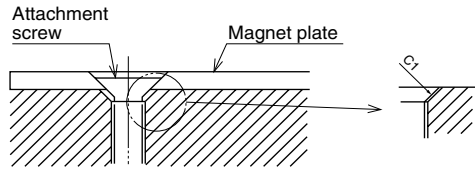

Unit attachment hole processing dimensions

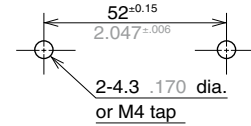

Unless the metal plate and the yoke are flush with each other, adhesive power will be lost, and there is a risk that the switch will not operate.

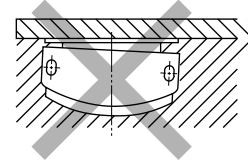

Adhesion board hole processing dimensions

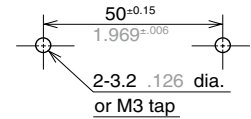

(Fit a C1 panel to the inlet vent)

SUITABLE WIRING

• Maximum external dimensions upon completion

Circular: 8mm dia. .315 inch dia. max.
Flat: Lengthwise 9.4mm .370inch max.
(VVF 2 cores, conductor radius 1.6 dia.)

• Wiring processing dimensions

Refer to the diagram below for the wiring processing dimensions

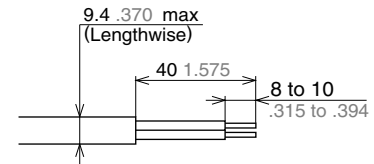
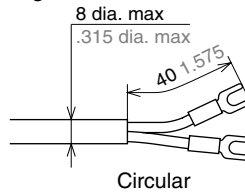

WIRING

- Terminal uses a M3.5 angle washer attachment.
- During wiring work, do not connect the lead wire directly to the terminal, but via a crimp contact. However, this excludes single wiring.
- Wiring by solder should be avoided.

- Wiring method
Insert a flat screwdriver into the indentation of the product side, and remove the terminal cover.

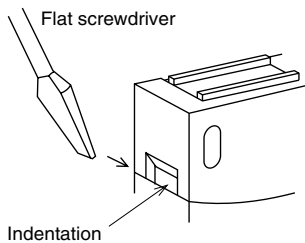

- Slide the rubber cap and the terminal cover over the wire, as shown in the illustration then attach a crimp contact to the terminal. The torque applied to the terminal screw should be within the range of 0.39-0.59 Nm (4-6 kg/cm).

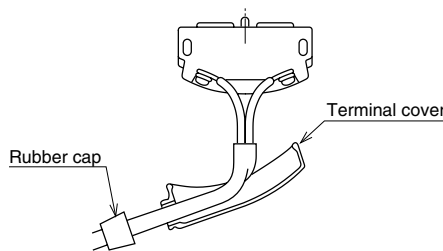

- If using a VVF wire, bend the wire towards the unit, and once it has taken the proper shape, install the terminal cover. After installing the terminal cover, attach the rubber cap.

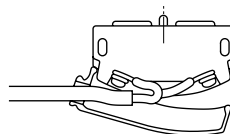

CAUTIONS FOR USE

- Because the magnelimit is not water-proof, avoid using in areas where it may be splashed with either water or oil. Also, avoid using in locations where dust may accumulate.
- Do not use in atmospheres where the unit may directly come into contact with any kind of organic solvent, strong acid or alkaline liquids, or combustible or corrosive gasses.
- Avoid using in silicon environments such as organic silicon-based rubber, solvents, sealants, oil, grease, or wiring.
- The moveable parts on the magnelimit such as the gates are equipped with a stopper, so avoid attachments that require them to bear the full load.
- In order to improve reliability under actual working conditions, check the quality under as close to actual working conditions as possible.
- This magnelimit has a built-in electro-magnet. For this reason, take care not to place floppy disks, magnetic cards, or other magnetic recording mediums near the unit, as the data may be corrupted or lost.

单击下面可查看定价，库存，交付和生命周期等信息

[>>Panasonic\(松下\)](#)