

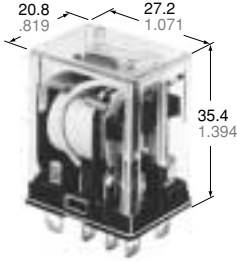

Panasonic
ideas for life

**15A (1C), 10 A (2C)
SPACE SAVING
POWER RELAY**

HL RELAYS



mm inch

FEATURES

- **High switching capacity in a compact size**
1 Form C (15 A 125 V AC), 2 Form C (10 A 250 V AC)
- **Rugged construction for tough applications**
- **Long life**
Mechanical: Min. 10^8 operations (DC),
Min. 5×10^7 operations (AC)
Electrical: Min. 5×10^5 operations

SPECIFICATIONS

Contacts

Arrangement		1 Form C	2 Form C
Initial contact resistance, max. (By voltage drop 6 V DC 1 A)		50 mΩ	
Contact material		Silver alloy	
Rating (resistive)	Nominal switching capacity	15 A 125 V AC, 10 A 250 V AC	10 A 250 V AC
	Max. switching power	AC: 2,500 VA DC: 90 W	AC: 2,500 VA DC: 90 W
	Max. switching voltage	250 V AC 30 V DC	250 V AC 30 V DC
	Max. switching current	15 A	10 A
	Min. switching capacity ^{#1}	100 mA, 5 V DC	
Expected life	Mechanical (at 180 cpm)	5×10^7 (AC), 10^6 (DC)	
	Electrical (resistive)	15 A 125 V AC	5×10^5
		10 A 250 V AC	5×10^5
	3 A 30 V DC	5×10^5	

#1 This value can change due to the switching frequency, environmental conditions, and desired reliability level, therefore it is recommended to check this with the actual load.

Remarks

- * Specifications will vary with foreign standards certification ratings.
- *1 Measurement at same location as "Initial breakdown voltage" section
- *2 Detection current: 10 mA
- *3 Excluding contact bounce time
- *4 Half-wave pulse of sine wave: 11ms; detection time: 10μs
- *5 Half-wave pulse of sine wave: 6ms
- *6 Detection time: 10μs
- *7 Refer to 6. Conditions for operation, transport and storage mentioned in AMBIENT ENVIRONMENT

Characteristics (at 25°C 77°F, 50% Relative humidity)

Max. operating speed		20 cpm
Initial insulation resistance*1		Min. 100 MΩ (at 500 V DC)
Initial breakdown voltage*2	Between contact sets	1,500 Vrms for 1 min.
	Between open contacts	1,000 Vrms for 1 min.
	Between contacts and coil	2,000 Vrms for 1 min.
Operate time (at nominal voltage)		Max. 25 ms (DC type) Max. 25 ms (AC type)
Release time*3 (without diode) (at nominal voltage)		Max. 25 ms (DC type) Max. 25 ms (AC type)
Temperature rise, max. (at nominal voltage)		Max. 80°C
Shock resistance	Functional*4	Min. 196 m/s ² {20 G}
	Destructive*5	Min. 980 m/s ² {100 G}
Vibration resistance	Functional*6	10 to 55 Hz at double amplitude of 1 mm
	Destructive	10 to 55 Hz at double amplitude of 2 mm
Conditions for operation, transport and storage*7 (Not freezing and condensing at low temperature)	Ambient temperature	-50°C to +70°C -58°F to +158°F
	Humidity	5 to 85% R.H.
Unit weight		Approx. 35 g 1.25 oz

TYPICAL APPLICATIONS

Power station control equipment,
refrigerators, building control equipment,
office machines, and medical equipment.

ORDERING INFORMATION

Ex. HL 2 — H — AC240V

Contact arrangement	Terminal arrangement	Coil voltage
1: 1 Form C 2: 2 Form C	H: Plug-in HP: PC board HTM: Top mounting L: Light emitting diode wired, plug-in PL: Light emitting diode wired, PC board	AC 6, 12, 24, 48, 120, 240 V DC 6, 12, 24, 48, 110 V

Note: Standard packing Carton: 20 pcs., Case: 200 pcs.
UL/CSA approved type is standard.

COIL DATA (at 20 °C 68°F)

DC coils

Coil voltage, V DC	Pick-up voltage, V DC (max.)	Drop-out voltage, V DC (min.)	Max. allowable voltage, V DC	Coil resistance, Ω (±10%)	Nominal coil current, mA	Operating power, W	
						Nominal	Minimum
6	4.8	0.6	6.6	40	150	0.90	0.58
12	9.6	1.2	13.2	160	75		
24	19.2	2.4	26.4	650	37		
48	38.4	4.8	52.8	2,600	18.5	1.0	0.64
110	88.0	11.0	121.0	10,000	10		

AC coils at 60 Hz

Coil voltage, V DC	Pick-up voltage, V AC (max.)	Drop-out voltage, V AC (min.)	Max. allowable voltage, V AC	Nominal coil current, mA	Operating power, VA	
					Nominal	Minimum
6	4.8	1.8	6.6	200	1.20	0.77
12	9.6	3.6	13.2	100		
24	19.2	7.2	26.4	50		
48	38.4	14.4	52.8	25		
110/120	88	36	132	10.9/11.9		
220/240	176	72	264	6.0/6.5		

Notes:

1. The range of coil current is ±15% for AC (60 Hz), ±10% for DC, at 20°C.
2. The relay may be used in the range of 80% to 110% of the nominal coil voltage. However, it is recommended that the relay be used at 85% to 110% nominal voltage to take temporary voltage variations into consideration.
3. Each coil resistance of DC types is the measured value at a coil temperature of 20°C. Please allow a compensation of ±0.4% resistance for each coil temperature change of ±1°C.

4. All AC 240 V types are rated for double coil voltages, both AC 220 V and AC 240 V.
5. For use with 220 or 240 V DC, connect a resistor, as suggested below, in series with the 110 V DC relay.

Voltage	1 Form C, 2 Form C
220 V DC	11 kW (5 W)
240 V DC	13 kW (5 W)

DIMENSIONS

mm inch

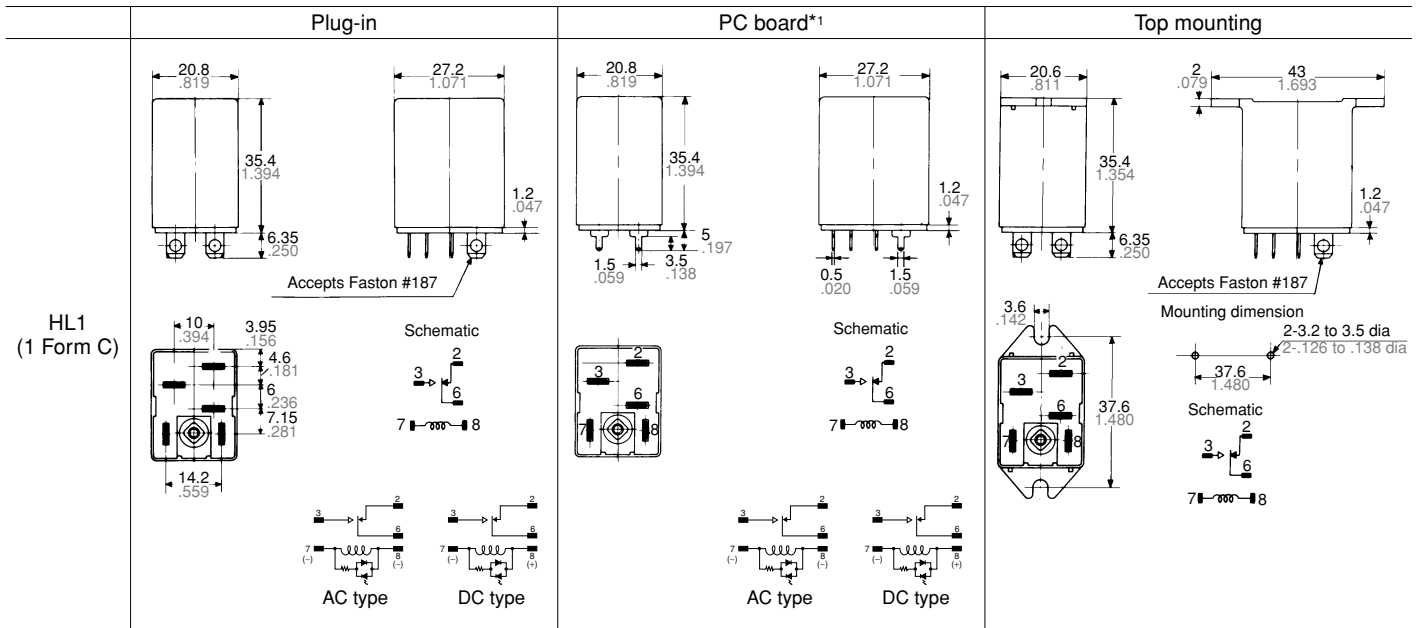

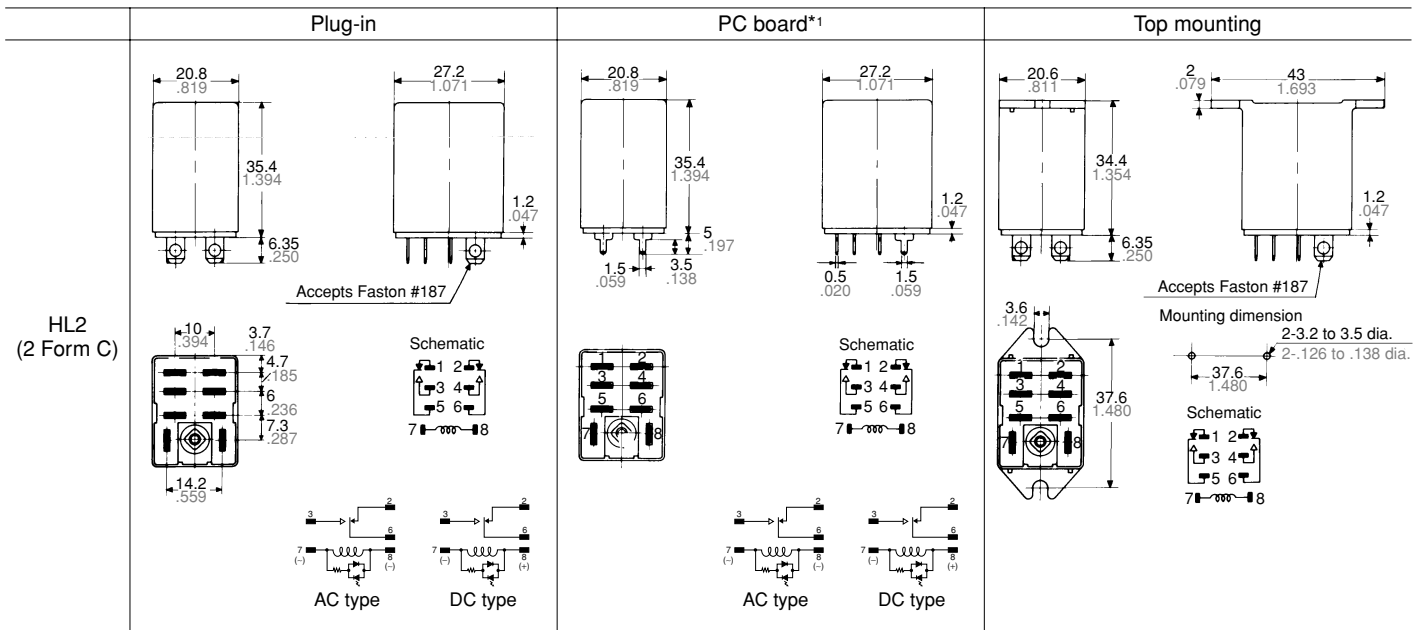

Tolerance: $\pm 0.5 \pm .020$

*1 PC board pattern

Copper-side view

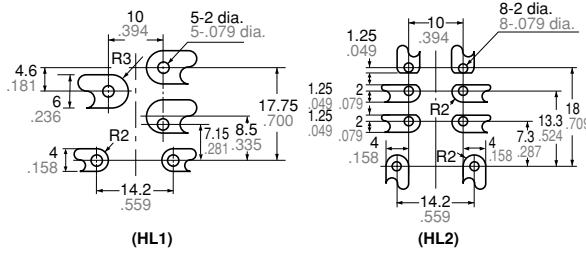
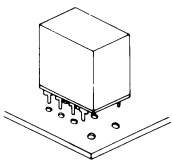

Tolerance: $\pm 0.1 \pm .004$

ACCESSORIES

HL1-SS-K (with hold-down clip)

HL2-SS-K (with hold-down clip)

Plug-in terminal socket mount
Simply insert socket into panel hole and push down as indicated to lock socket in place.

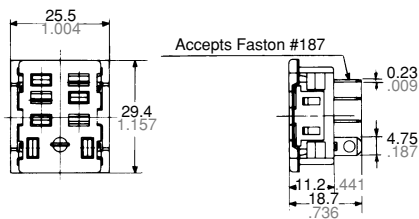
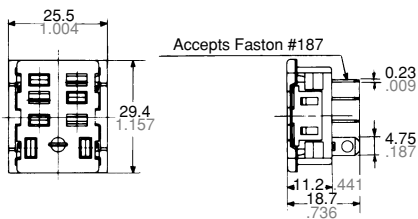
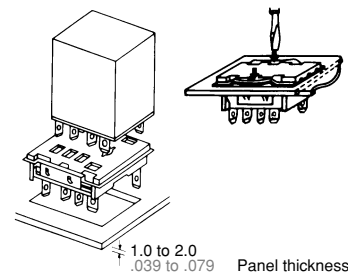

Panel cutout

Panel cutout

Panel cutout for tandem mounting

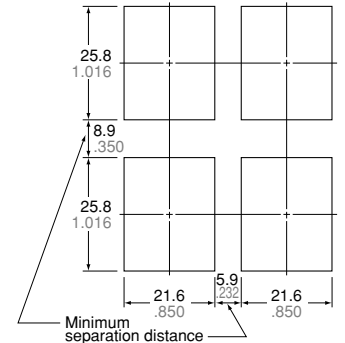
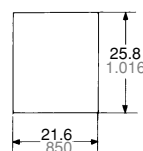
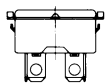
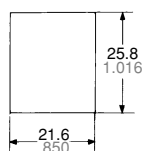
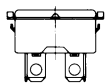

Tolerance: $\pm 0.1 \pm .004$

2. PC board terminal socket

HL1-PS-K

HL2-PS-K

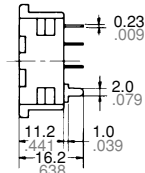
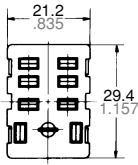

PC board pattern

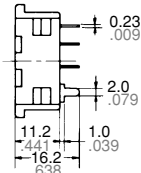
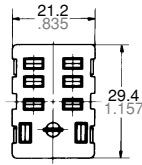
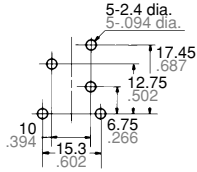

PC board pattern

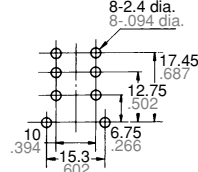

Layout for tandem mounting (2 Form C)

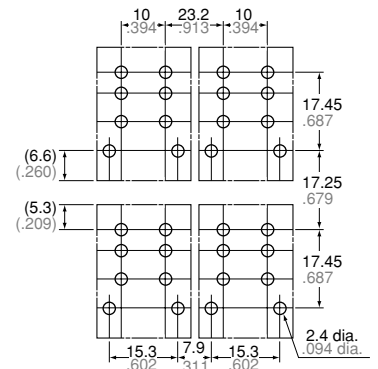

Tolerance: $\pm 0.1 \pm 0.04$

3. Screw terminal socket for DIN rail assembly

HL2-SFD-K (with hold-down clip)

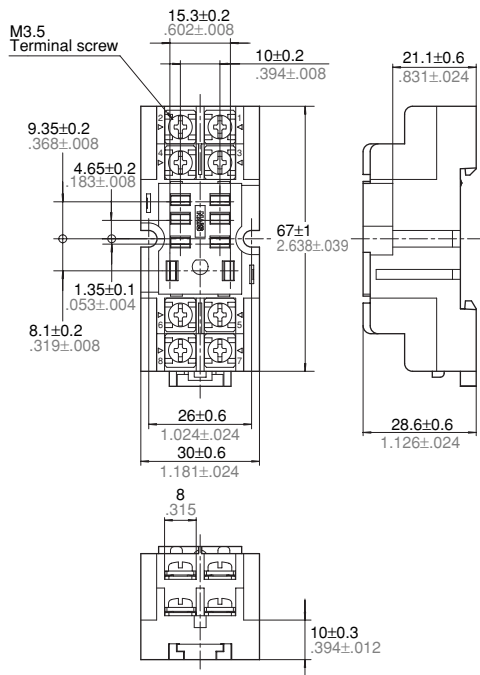
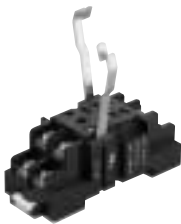

Schematic

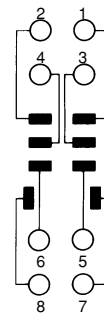

Layout for tandem mounting

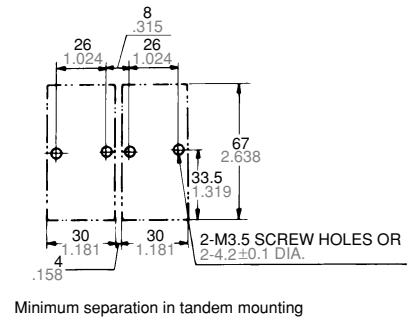

Minimum separation in tandem mounting

Tolerance: $\pm 0.1 \pm 0.04$

(Remark) Max. continuous current of all HL sockets is 10 A.

For Cautions for Use, see Relay Technical Information

单击下面可查看定价，库存，交付和生命周期等信息

[>>Panasonic\(松下\)](#)