

## Anti-Sulfurated Chip Resistors Array

EXB type

**EXB U14, U18, U24, U28** series

**EXB U2H, U34, U38** series

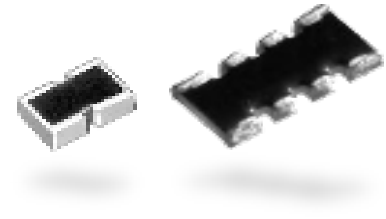

### Features

- High resistance to sulfurization achieved by adopting an Ag-Pd-based inner electrode
- High density
  - 2 resistors in 0.8 mm × 0.6 mm size / 0302 inch size : EXBU14
  - 4 resistors in 1.4 mm × 0.6 mm size / 0502 inch size : EXBU18
  - 2 resistors in 1.0 mm × 1.0 mm size / 0404 inch size : EXBU24
  - 4 resistors in 2.0 mm × 1.0 mm size / 0804 inch size : EXBU28
  - 8 resistors in 3.8 mm × 1.6 mm size / 1506 inch size : EXBU2H
  - 2 resistors in 1.6 mm × 1.6 mm size / 0606 inch size : EXBU34
  - 4 resistors in 3.2 mm × 1.6 mm size / 1206 inch size : EXBU38
- Improvement of placement efficiency  
Placement efficiency of chip resistor array is two, four or eight times of the flat type chip resistor
- Reference standard : IEC 60115-9, JIS C 5201-9, EIAJ RC-2129
- AEC-Q200 compliant (EXBU2, EXBU3)
- RoHS compliant

■ As for packaging methods, land pattern, soldering conditions and safety precautions, please see data files.

### Explanation of part numbers

Note : Please check the "Ratings" for the presence/absence of part numbers for combinations of the symbols below.

1	2	3	4	5	6	7	8	9	10	11	
E	X	B	U	2	8	4	7	2	J	X	
Product code	Code	inch size	Construction	Resistance value			Resistance tolerance		Packaging methods		
	Code	inch size	Construction	Resistance value			Code	Tolerance	Code	Packaging	Part No.
Thick film chip resistor networks	U14	0201×2	Convex terminal	The first two digits are significant figures of resistance value and the third one denotes the number of zeros following. Jumper is expressed by R00. (Ex.) 222 : 2.2 kΩ			J	±5 %	X	Punched carrier taping 2 mm pitch, 10,000 pcs	EXBU14
	U18	0201×4	Flat terminal				EXBU18				
	U24	0402×2	Convex terminal				EXBU24				
	U28	0402×4	Convex terminal				EXBU28				
	U2H	0602×8	Convex terminal				EXBU2H				
	U34	0603×2	Convex terminal				EXBU34				
U38	0603×4	Convex terminal	EXBU38	V	Punched carrier taping 4 mm pitch, 5,000 pcs	EXBU34	EXBU38				

## Ratings

### [For Resistor]

Part No. (inch size)	Power rating (70 °C) (W/element)	Limiting element voltage <sup>*1</sup> (V)	Maximum overload voltage <sup>*2</sup> (V)	Resistance tolerance (%)	Resistance range (Ω)	T.C.R. (×10 <sup>-6</sup> /K)	Category temperature range (°C)	AEC-Q200 Grade
EXBU14 (0201×2)	0.031	12.5	25	±5	10 to 1 M (E24)	R<10 Ω : -200 to +600  10 Ω to 1 MΩ : ±200	-55 to +125	Grade 1
EXBU18 (0201×4)	0.031 (0.1 W / package)	12.5	25	±5	10 to 1 M (E24)			
EXBU24 (0402×2)	0.063	50	100	±5	1 to 1 M (E24)			
EXBU28 (0402×4)	0.063	50	100	±5	1 to 1 M (E24)			
EXBU2H (0602×8)	0.063 (0.25 W / package)	25	50	±5	10 to 1 M (E24)			
EXBU34 (0603×2)	0.063	50	100	±5	1 to 1 M (E24)			
EXBU38 (0603×4)	0.063	50	100	±5	1 to 1 M (E24)			

\*1: Rated Continuous Working Voltage (RCWV) shall be determined from  $RCWV = \sqrt{\text{Power Rating} \times \text{Resistance Value}}$ , or Limiting Element Voltage listed above, whichever less.

\*2: Overload Test Voltage (OTV) shall be determined from  $OTV = \text{Specified Magnification (refer to performance)} \times RCWV$  or Maximum Overload Voltage listed above, whichever less.

### [For Jumper]

Part No.	Resistance	Rated current	Maximum overload current <sup>*1</sup>
EXBU24	100 mΩ or less	1 A	2 A
EXBU28			
EXBU2H			
EXBU34			
EXBU38			

\*1: Overload test current

### Power derating curve

For resistors operated in ambient temperatures above 70°C, power rating shall be derated in accordance with the figure below.

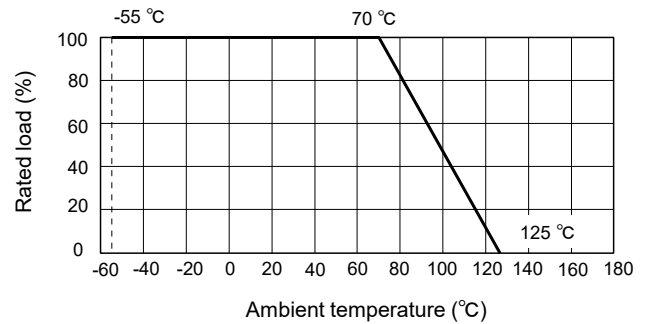

## Construction

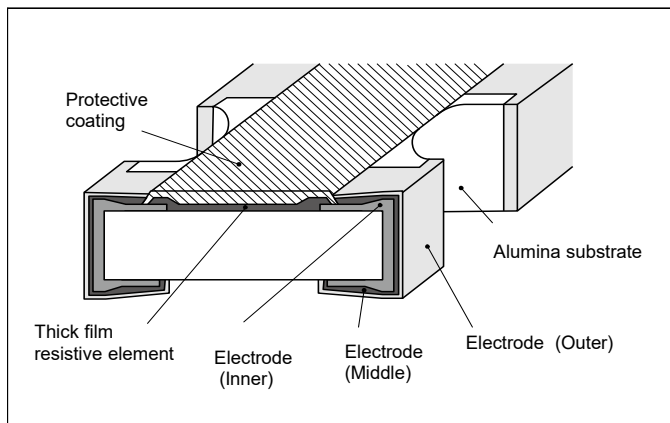

## Schematics

### ● Isolated type

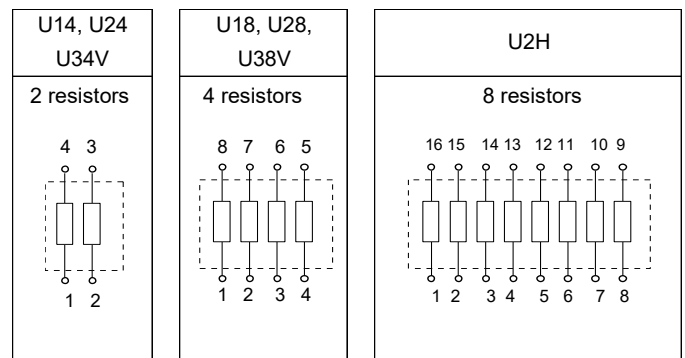

## Anti-Sulfurated Chip Resistors Array

### Dimensions (not to scale)

EXBU14, U24, U34

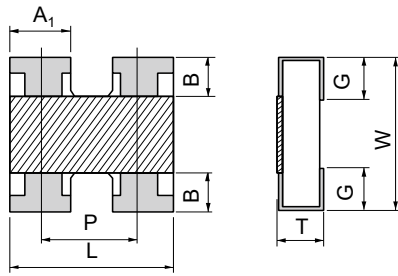

EXBU18

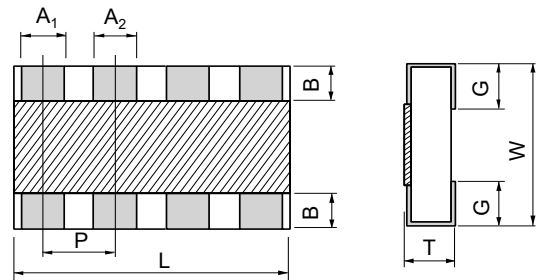

EXBU28, U38

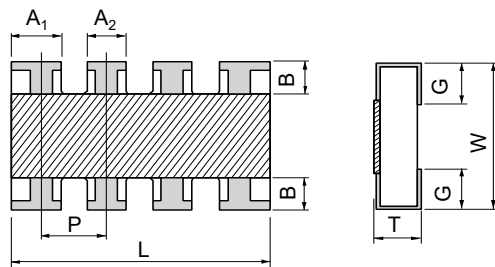

EXBU2H

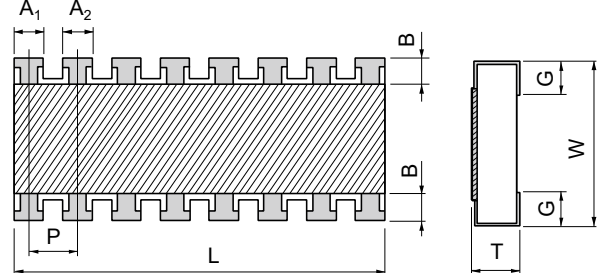

Unit : mm

Part No. (inch size)	Dimensions								Mass (Weight) (Reference) (g/1000 pcs)
	L	W	T	A <sub>1</sub>	A <sub>2</sub>	B	P	G	
EXBU14 (0201X2)	0.80±0.10	0.60±0.10	0.35±0.10	0.35±0.10	—	0.15±0.10	(0.50)	0.15±0.10	0.5
EXBU18 (0201×4)	1.40±0.10	0.60±0.10	0.35±0.10	0.20±0.10	0.20±0.10	0.10±0.10	(0.40)	0.20±0.10	1.0
EXBU24 (0402×2)	1.00±0.10	1.00±0.10	0.35±0.10	0.40±0.10	—	0.18±0.10	(0.65)	0.25±0.10	1.2
EXBU28 (0402×4)	2.00±0.10	1.00±0.10	0.35±0.10	0.45±0.10	0.35±0.10	0.20±0.10	(0.50)	0.25±0.10	2.0
EXBU2H (0602×8)	3.80±0.10	1.60±0.10	0.45±0.10	0.35±0.10	0.35±0.10	0.30±0.10	(0.50)	0.30±0.10	9.0
EXBU34 (0603×2)	1.60±0.20	1.60±0.15	0.50±0.10	0.65±0.15	—	0.30±0.20	(0.80)	0.30±0.20	3.5
EXBU38 (0603×4)	3.20±0.20	1.60±0.15	0.50±0.10	0.65±0.15	0.45±0.15	0.30±0.20	(0.80)	0.35±0.20	7.0

( ) Reference

### Performance

Test Item	Performance requirements ΔR	Test conditions
Resistance	Within specified tolerance	20 °C
T. C. R.	Within Specified T. C. R.	+25 °C / +125 °C
Overload	±2 %	Rated voltage x 2.5, 5 s Jumper type : Max. overload current, 5 s
Resistance to soldering heat	±1 %	270 °C, 10 s
Rapid change of temperature	±1 %	-55 °C (30 min.) / +125 °C (30 min.), 100 cycles
High temperature exposure	±1 %	+125 °C, 1000 h
Damp heat, Steady state	±1 %	60 °C, 90 % to 95 %RH, 1000 h
Load life in humidity	±3 %	60 °C, 90 % to 95 %RH, Rated voltage (Jumper type : Rated current), 1.5 h ON / 0.5 h OFF cycle, 1000 h
Endurance at 70 °C	±3 %	70 °C, Rated voltage (Jumper type : Rated current), 1.5 h ON / 0.5 h OFF cycle, 1000 h

## Safety and Legal Matters to Be Observed

### Product specifications and applications

- Please be advised that this product and product specifications are subject to change without notice for improvement purposes. Therefore, please request and confirm the latest delivery specifications that explain the specifications in detail before the final design, or purchase or use of the product, regardless of the application. In addition, do not use this product in any way that deviates from the contents of the company's delivery specifications.
- Unless otherwise specified in this catalog or the product specifications, this product is intended for use in general electronic equipment (AV products, home appliances, commercial equipment, office equipment, information and communication equipment, etc.).  
When this product is used for the following special cases, the specification document suited to each application shall be signed/sealed (with Panasonic Industry and the user) in advance..These include applications requiring special quality and reliability, wherein their failures or malfunctions may directly threaten human life or cause harm to the human body (e.g.: space/aircraft equipment, transportation/traffic equipment, combustion equipment, medical equipment, disaster prevention/crime prevention equipment, safety equipment, etc.).

### Safety design and product evaluation

- Please ensure safety through protection circuits, redundant circuits, etc., in the customer's system design so that a defect in our company's product will not endanger human life or cause other serious damage.
- This catalog shows the quality and performance of individual parts. The durability of parts varies depending on the usage environment and conditions. Therefore, please ensure to evaluate and confirm the state of each part after it has been mounted in your product in the actual operating environment before use.  
If you have any doubts about the safety of this product, then please notify us immediately, and be sure to conduct a technical review including the above protection circuits and redundant circuits at your company.

### Laws / Regulations / Intellectual property

- The transportation of dangerous goods as designated by UN numbers, UN classifications, etc., does not apply to this product. In addition, when exporting products, product specifications, and technical information described in this catalog, please comply with the laws and regulations of the countries to which the products are exported, especially those concerning security export control.
- Each model of this product complies with the RoHS Directive (Restriction of the use of hazardous substances in electrical and electronic equipment) (2011/65/EU and (EU) 2015/863). The date of compliance with the RoHS Directive and REACH Regulation varies depending on the product model.  
Further, if you are using product models in stock and are not sure whether or not they comply with the RoHS Directive or REACH Regulation, please contact us by selecting "Sales Inquiry" from the inquiry form.
- During the manufacturing process of this product and any of its components and materials to be used, Panasonic Industry does not intentionally use ozone-depleting substances stipulated in the Montreal Protocol and specific bromine-based flame retardants such as PBBs (Poly-Brominated Biphenyls) / PBDEs (Poly-Brominated Diphenyl Ethers). In addition, the materials used in this product are all listed as existing chemical substances based on the Act on the Regulation of Manufacture and Evaluation of Chemical Substances.
- With regard to the disposal of this product, please confirm the disposal method in each country and region where it is incorporated into your company's product and used.
- The technical information contained in this catalog is intended to show only typical operation and application circuit examples of this product. This catalog does not guarantee that such information does not infringe upon the intellectual property rights of Panasonic Industry or any third party, nor imply that the license of such rights has been granted.
- Design, materials, or process related to technical owned by Panasonic Industry are subject to change without notice.

**Panasonic Industry will assume no liability whatsoever if the use of our company's products deviates from the contents of this catalog or does not comply with the precautions. Please be advised of these restrictions.**

## Matters to Be Observed When Using This Product

### (Fixed resistor)

#### Use environments and cleaning conditions

- This product (fixed resistor) is not designed for use in specific environments. Using the resistor in the following specific environments or service conditions may affect the performance/reliability of the resistor. Avoid using it in such specific environments. If you intend to use the resistor in such environments, checking the performance, reliability, etc., of the product sufficiently is your own responsibility.
  - (1) Used in liquid, such as water, oil, chemicals, and organic solvents.
  - (2) Used in a place exposed to direct sunlight, an outdoor place with no shielding, or a dusty place.
  - (3) Used in a place where the product is heavily exposed to sea breeze or a corrosive gas, such as Cl<sub>2</sub>, H<sub>2</sub>S, NH<sub>3</sub>, SO<sub>2</sub>, or NO<sub>x</sub>.
  - (4) Used in an environment where static electricity and electromagnetic waves are strong.
  - (5) Located close to a heating component or a flammable material, such as a vinyl cable placed near the product.
  - (6) Sealed or coated with a resin.
  - (7) Solder flux of the resistor soldered with no-clean type solder, etc., is cleansed with a solvent, water, or a water-soluble cleaner, etc. (Water-soluble flux residues have a particularly large influence on a resistor.)
  - (8) Used in a place where dew concentrates on the product.
  - (9) Used in a contaminated state.  
(Example: Touching the resistor mounted on a printed board leaving sebum on the resistor (improper handling))
- Sealing the resistor with a resin in a resin potting process, damp-proofing process, etc., applies excessive stress to the resistor, which may cause the internal electrodes a connection problem. In such cases, the proper operation of the resistor is not guaranteed. If you intend to use the resistor in such environments, checking the performance, reliability, etc., of the product sufficiently is your own responsibility.
- Do not leave the resistor immersed in a solvent for a long time. When using the resistor immersed in a solvent, confirm the operation of the product mounted on the board.
- When a cleaning solution or cleaning condition for cleaning the printed board or a drying condition for drying the printed board after soldering the resistor is improper, it may have a negative effect on the performance/reliability of the resistor. Confirming these conditions sufficiently is your own responsibility. Also examine the effects of soiled cleaning agent, cleaning residues, and post-cleaning contaminations, and control for these effects properly.

#### Response to anomalies and handling conditions

- When the resistor is heating abnormally or emitting a smell, stop using the resistor immediately, for example, turn off the main power supply of the device.  
Also, keep your face and hands away from the product as it may become hot and cause burns.
- The resistor is so thin that it may break easily when subjected to impact. Before putting the resistor in use, confirm that the resistor has not been broken by impact that applied thereto when mounted on the printed board. Applying impact to the resistor or pinching the resistor with a hard tool (pliers, tweezers, etc.) may chip the resistor or its protective film, which affects its performance. Be careful to avoid such cases.
- Do not reuse a resistor having been used on a printed board and removed therefrom. Do not touch the resistor with your bare hands.
- Be careful not to drop the resistor on the floor, etc. The resistor is likely to suffer mechanical or electrical damage when dropped on the floor. Avoid using said resistor.
- The resistor may have its resistance value changed due to electrostatic discharge (ESD). Take ESD prevention measures when handling the resistor. ESD prevention measures include an environment where static electricity is not likely to be generated (recommended RH: 40% to 60%), by wearing an earth band, conductive gloves, etc., grounding the device in which the resistor is incorporated, and placing a conductive mat, etc., on a work platform.
- It is guaranteed that a resistor not exposed to any stress will have its proper resistance value. Any stress or pressure applied to the resistor may cause its resistance value to change. Examine and evaluate the characteristics of the resistor sufficiently before using it.

## Reliability and product life

A product conforming to "AEC-Q200" refers to a product having passed some or all of the evaluation test items defined in AEC-Q200. To know the detailed specifications of individual products or specific evaluation test scores, please contact us. We issue a delivery specification sheet for each product ordered. Please confirm with the sheet when you place an order with us.

## Circuit design and circuit board design

- To prevent a case where a transient load (e.g., a pulse for a short period) too large for the product to handle is applied, make sure to evaluate and confirm the operation of the product incorporated in your product. Applying power or voltage (current) larger than the rated power or rated voltage (current) to the resistor may impair its performance and reliability. Make sure to use the resistor with power or voltage (current) equal to or lower than the rated power or rated voltage (current). The product warranty does not cover usage where an excessively large load, such as a pulse current, is applied to the product.
- The resistor may have a high temperature even when used with power equal to or lower than the rated power. Be careful in such cases. Another factor to be considered are effects on the board, peripheral components, etc., and the effects of peripheral components on the resistor. Make sure to confirm first that the temperature of the resistor incorporated in your product is equal to or lower than the specified temperature, and then use the resistor.
- When the resistors are connected in series or parallel, loads applied respectively to the resistors may not be equal to each other. Check whether the loads are equal in the actual circuit in which the resistors are incorporated.
- When a resistor is used in a high-frequency circuit, the resistor may fail to offer the required characteristics. Check whether the resistor offers the required characteristics in the actual circuit in which the resistors are incorporated.
- Be careful that unusual stress caused by an excessive bend of the printed board is not applied to the resistor. Design the circuit structure such that the resistor is not close to a perforated line for board splitting or on a line with sizable holes bored on the board.
- When a different component is mounted on the board where the resistor has been soldered, be careful that the board does not bend excessively. If necessary, provide the board with backup pins (support pins) to keep it straight.
- Avoid manual board splitting. Use a jig, etc., to break the board so that it does not bend excessively when split apart.

## Mounting conditions

- When the product is used under mounting conditions departing from mounting conditions specified in our specification sheet, the product may be exposed to unexpected stress to fail. Be careful to avoid such a case. When mounting the resistor on a printed board, set the resistor's front and back surfaces in the direction indicated by the tape. Make sure to evaluate and confirm the operation of the resistor incorporated in your product and determine whether the resistor is usable as a component of the product.
- Set soldering conditions for the resistor within the recommended soldering conditions specified by our company. Any time, soldering condition departing from the specified soldering condition, such as a high peak temperature or a long heating may impair the performance/reliability of the resistor. Note that the specified soldering conditions indicate conditions under which degradation of the resistor characteristics does not occur but do not indicate conditions under which stable soldering can be performed. Check and set individual conditions under which stable soldering can be performed.
- Heat the resistor in advance so that a difference between the soldering temperature and the temperature of the resistor surface is reduced to 100 °C or lower. When dipping the soldered resistor in a solvent, etc., to cool the resistor rapidly, ensure that the temperature difference between the resistor and the solvent is 100 °C or lower during the dipping.
- When soldering the resistor using a soldering iron, apply hot air, etc., to the resistor to heat it sufficiently in advance and then solder the resistor without bringing the soldering iron tip into contact with the product. If the temperature of the soldering iron tip is high, finish the soldering work quickly (within 3 seconds when the temperature of the soldering iron tip is 350 °C or lower). In the case of a fixed resistor with low resistance, the resistor may fail to offer the exactly intended resistance value because of the variation in the solder volume, etc. Make sure to confirm the resistance value of the resistor in the actual circuit configuration.

- Soldering the resistor with too much solder or too little solder results in the poor reliability of the solder connection of the resistor. Use the proper volume of solder in the soldering process. Sufficiently check for the volume of solder used.
- Soldering with high bond strength or special property solder may affect the quality of the resistor. Do not use such solder.
- Use rosin-based solder flux. When using highly active solder flux made mainly of halogen (chlorine, bromine, etc.), flux residues may affect the performance and reliability of the resistor. Check the effects of flux residues before using the solder flux. Do not use highly acidic flux, water-soluble flux, or flux containing fluoride ions. When solder flux sticks to the resistor after the soldering process, the activation energy of the flux may corrode the resistor and cause it to fail. Prevent solder flux from sticking to the resistor.

## Storage conditions

Keeping the product in the following environments or conditions may lead to degradation of its performance, solderability, etc. Do not keep the product in the following environments.

- (1) Stored in a place where the product is heavily exposed to sea breeze or a corrosive gas, such as Cl<sub>2</sub>, H<sub>2</sub>S, NH<sub>3</sub>, SO<sub>2</sub>, or NO<sub>x</sub>.
- (2) Stored in a place where the product is exposed to direct sunlight.
- (3) Stored in a place where a temperature condition of 5 °C to 35 °C and a relative humidity condition of 45% to 85% cannot be maintained.
- (4) Kept in storage for more than one year from the delivery date (when the product is kept in conditions excluding any of the environments (1) to (3)).

## Reference information

### Guidelines

Before using the resistor, refer to the technical report issued by JEITA, EIAJ RCR-2121B "Safety Application Guide for Fixed Resistor for Use in Electronic Equipment" revised in February 2015.

单击下面可查看定价，库存，交付和生命周期等信息

[>>Panasonic\(松下\)](#)