



FEATURES

- Sound pressure reduced by approx. 20 dB from that of the company's non-silent relays
- Space saving
- Adopting standard terminal pitch (for compact relays)
- Plastic sealed type
- Wiper load models are listed

TYPICAL APPLICATIONS

For intermittent wipers and applications requiring quiet operation

ORDERING INFORMATION

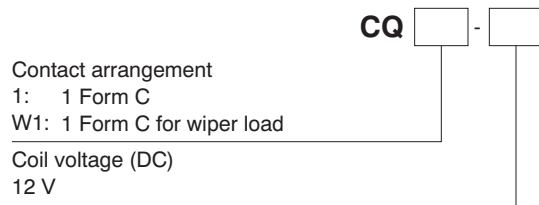

TYPES

Contact arrangement	Coil voltage	Model No.	Part No.
1 Form C	12V DC	ACQ131	CQ1-12V
1 Form C for wiper load		ACQW131	CQ1W-12V

Standard packing; Carton (tube): 40 pcs.; Case: 800 pcs.

RATING

1. Coil data

Nominal coil voltage	Pick-up voltage (at 20°C 68°F)	Drop-out voltage (at 20°C 68°F)	Nominal operating current [±10%] (at 20°C 68°F)	Coil resistance [±10%] (at 20°C 68°F)	Nominal operating power	Usable voltage range
12V DC	Max. 7.2V DC (Initial)	Min. 1.0V DC (Initial)	53.3 mA	225Ω	640 mW	10 to 16V DC

Note: Other pick-up voltage types are also available. Please contact us for details.

2. Specifications

1) Standard CQ relay

Characteristics	Item	Specifications	
Contact	Arrangement	1 Form C	
	Contact resistance (Initial)	N.O.: Typ7mΩ, N.C.: Typ8mΩ (By voltage drop 6V DC 1A)	
	Contact voltage drop	Max. 0.2V (at 10 A)	
	Contact material	Ag alloy (Cadmium free)	
Rating	Nominal switching capacity (resistive load)	N.O.: 20A 14V DC, N.C.: 10A 14V DC	
	Max. carrying current (12V DC initial)*3	N.O.: 35A for 2 minutes, 25A for 1 hour (at 20°C 68°F) 30A for 2 minutes, 20A for 1 hour (at 85°C 185°F)	
	Nominal operating power	640 mW	
	Min. switching capacity (resistive load)*1	1A 14V DC	
Electrical characteristics	Insulation resistance (Initial)	Min. 100 MΩ (at 500V DC, Measurement at same location as "Breakdown voltage" section.)	
	Breakdown voltage (Initial)	Between open contacts	500 Vrms for 1 min. (Detection current: 10mA)
		Between contacts and coil	500 Vrms for 1 min. (Detection current: 10mA)
	Operate time (at nominal voltage)	Max. 10ms (at 20°C 68°F, excluding contact bounce time) (Initial)	
Release time (at nominal voltage)	Max. 10ms (at 20°C 68°F, excluding contact bounce time) (Initial)		
Mechanical characteristics	Shock resistance	Functional	Min. 100 m/s ² {10G} (Half-wave pulse of sine wave: 11ms; detection time: 10μs)
		Destructive	Min. 1,000 m/s ² {100G} (Half-wave pulse of sine wave: 6ms)
	Vibration resistance	Functional	10 Hz to 100 Hz, Min. 44.1 m/s ² {4.5G} (Detection time: 10μs)
		Destructive	10 Hz to 500 Hz, Min. 44.1 m/s ² {4.5G} Time of vibration for each direction; X, Y direction: 2 hours, Z direction: 4 hours
Expected life	Mechanical	Min. 10 ⁷ (at 120 cpm)	
	Electrical*4	<Resistive load> Min. 10 ⁵ (at nominal switching capacity, operating frequency: 1s ON, 9s OFF) <Motor load> Min. 3×10 ⁵ (Inrush 30A, steady 5A, 20A 14V DC at brake current) (Operating frequency: 1s ON, 2s OFF)	
Conditions	Conditions for operation, transport and storage*2	Ambient temperature: -40°C to +85°C -40°F to +185°F Humidity: 5% R.H. to 85% R.H. (Not freezing and condensing at low temperature)	
	Max. operating speed	6 cpm (at nominal switching capacity)	
Mass		Approx. 6.5g .23 oz	

Notes:

*1.This value can change due to the switching frequency, environmental conditions, and desired reliability level, therefore it is recommended to check this with the actual load.

*2.The upper operation ambient temperature limit is the maximum temperature that can satisfy the coil temperature rise value. Refer to "6. Usage, Storage and Transport Conditions" in [AMBIENT ENVIRONMENT section in Relay Technical Information](#).

*3.Depends on connection conditions. Also, this does not guarantee repeated switching. We recommend that you confirm operation under actual conditions.

*4.Motor load does not apply to wiper load applications.

2) For wiper load (ACQW131)

Anything outside of that given below complies with standard CQ relays.

Characteristics	Item	Specifications
Rating	Max. carrying current (12V DC initial)*1	N.O.: 25A for 1 minutes, 15A for 1 hour (at 20°C 68°F) <Wiper motor load (L = Approx. 1mH)>
Expected life	Electrical	N.O. side: Min. 5×10 ⁵ (Inrush 25A, steady 6A 14V DC) N.C. side: Min. 5×10 ⁵ (12A 14V DC at brake current) (Operating frequency: 1s ON, 9s OFF)

Note: *1. Depends on connection conditions. Also, this does not guarantee repeated switching. We recommend that you confirm operation under actual conditions.

REFERENCE DATA

1. Max. switching capability (Resistive load, initial)

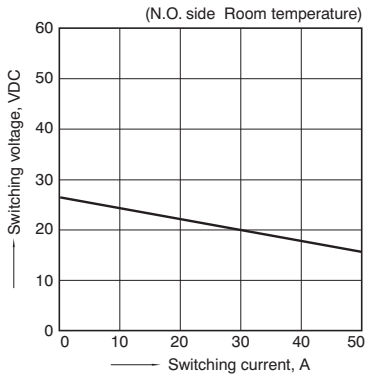

2. Ambient temperature and operating voltage range

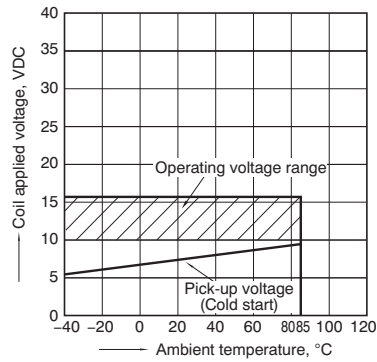

3. Ambient temperature characteristics

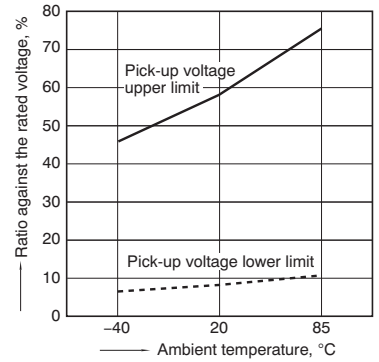

4. Distribution of pick-up and drop-out voltage
Sample: ACQ131, 100pcs

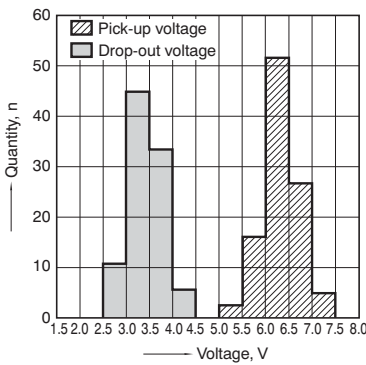

5. Distribution of operate time
Sample: ACQ131, 100pcs

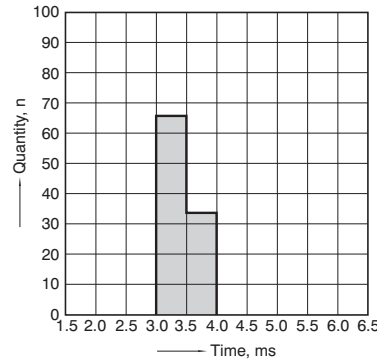

6. Distribution of release time
Sample: ACQ131, 100pcs

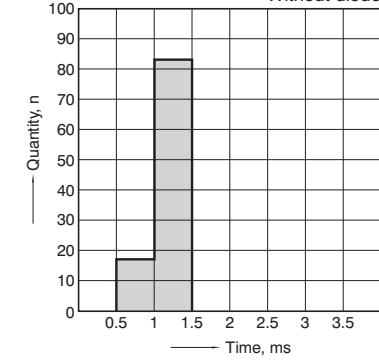

7. Electrical life test for wiper load (motor free)

Sample: ACQW131
Quantity: n = 3
Load: N.O. side: Inrush 25A, steady 6A 14V DC
N.C. side: Brake current 12A 14V DC
Operating frequency: ON 1s, OFF 9s
Ambient temperature: Room temperature
Circuit

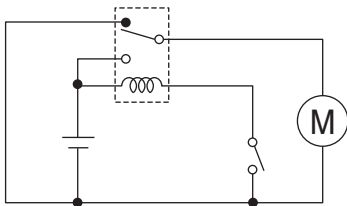

Change of pick-up and drop-out voltage

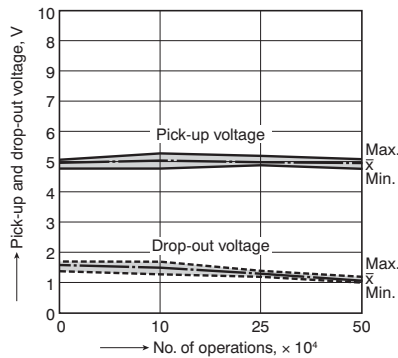

Change of contact resistance

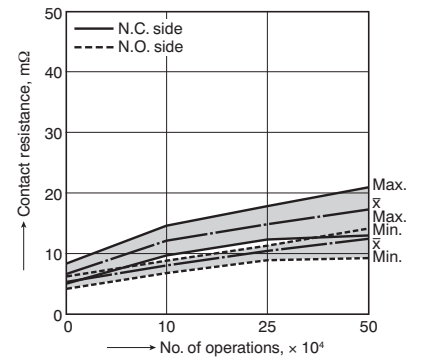

8.-(1) Operation noise distribution
When operate

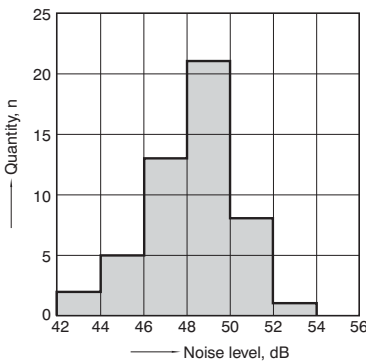

8.-(2) Operation noise distribution
When release

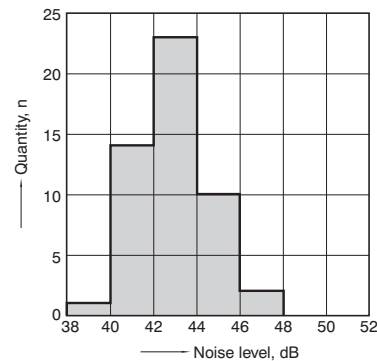

Measuring conditions
Sample: ACQ131, 50 pcs.
Equipment setting: "A" weighted, Fast, Max. hold
Coil voltage: 12V DC
Coil connection device: Diode
Background noise: Approx. 20dB

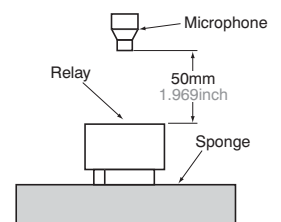

[CAD Data](#)



[CAD Data](#)

External dimensions

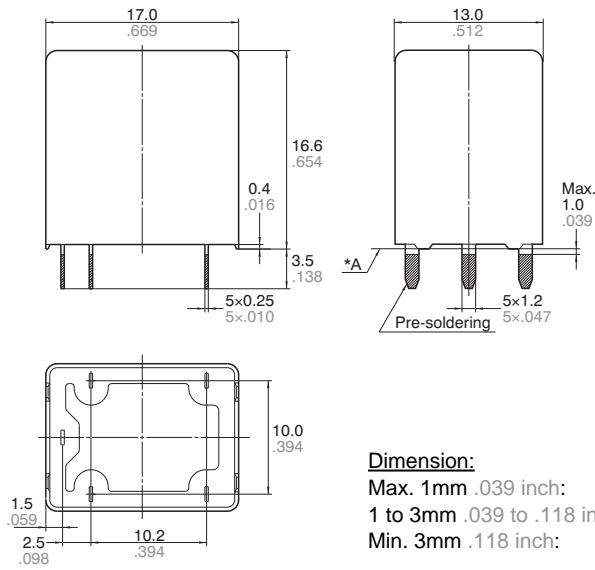

PC board pattern (Bottom view)

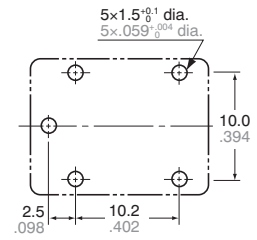

Tolerance: $\pm 0.1 \pm .004$

Schematic (Bottom view)

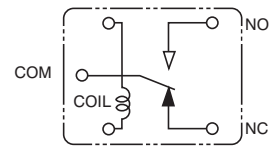

* Dimensions (thickness and width) of terminal is measured before pre-soldering.
Intervals between terminals is measured at A surface level.

For Cautions for Use, see [Relay Technical Information](#).

单击下面可查看定价，库存，交付和生命周期等信息

[>>Panasonic\(松下\)](#)