

**4 mm height!
2 A high capacity
1 Form C type ultra thin,
super miniature relay**

TK RELAYS

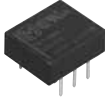

FEATURES

- 1. Compact and flat type**
10.6(L) × 9.0(W) × 4.0(H) .417(L) × .354(W) × .157(H)
- 2. High contact capacity: 2 A**
- 3. Outstanding surge resistance**
Surge breakdown voltage between contact and coil:
2,500 V 2 × 10 μsec. (Telcordia)
Surge breakdown voltage between open contacts:
1,500 V 10 × 160 μsec. (FCC part 68)

- 4. Initial breakdown voltage:**
1,500 Vrms for 1 min. (Between contact and coil)
- 5. Nominal operating power:**
High sensitivity of 140mW (Single side stable type)
By using the highly efficient polar magnetic circuit “seesaw balance mechanism”, a nominal operating power of 140 mW (minimum operating power of 79 mW) has been achieved.
- 6. Outstanding vibration and shock resistance**
Functional shock resistance: 750 m/s²
Destructive shock resistance: 1,000 m/s²
Functional vibration resistance: 10 to 55 Hz (at double amplitude of 3.3 mm .130 inch)
Destructive vibration resistance: 10 to 55 Hz (at double amplitude of 5 mm .197 inch)
- 7. The use of gold-clad twin crossbar contacts ensures high contact reliability.**
***We also offer a range of products with AgPd contacts suitable for use in low level load analog circuits (Max. 10V DC 10 mA).**
***SX relays designed for low level loads are also available.**

- 8. Self-clinching terminal also available**
- 9. Pre-soldering terminal**
- 10. Sealed construction allows automatic washing.**

TYPICAL APPLICATIONS

- 1. Computer peripherals**
- 2. Telephone devices and telecommunications equipment**
- 3. Crime and disaster prevention equipment**
- 4. Machine tools**

ORDERING INFORMATION

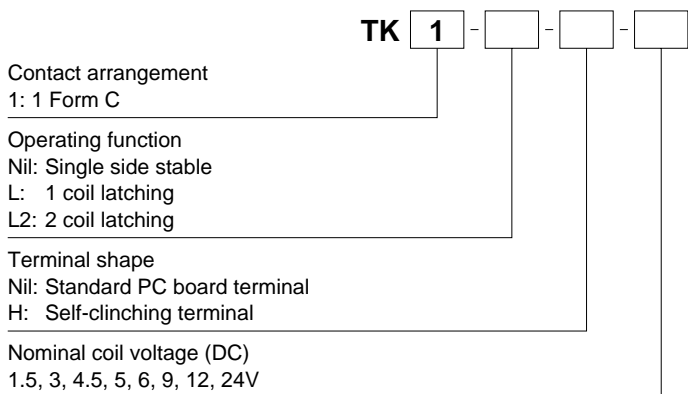

Contact arrangement
1: 1 Form C

Operating function
Nil: Single side stable
L: 1 coil latching
L2: 2 coil latching

Terminal shape
Nil: Standard PC board terminal
H: Self-clinching terminal

Nominal coil voltage (DC)
1.5, 3, 4.5, 5, 6, 9, 12, 24V

Note: In case of 5 V drive circuit, it is recommended to use 4.5 V type relay.

TYPES

1) Standard PC board terminal

Contact arrangement	Nominal coil voltage	Single side stable	1 coil latching	2 coil latching
		Part No.	Part No.	Part No.
1 Form C	1.5V DC	TK1-1.5V	TK1-L-1.5V	TK1-L2-1.5V
	3V DC	TK1-3V	TK1-L-3V	TK1-L2-3V
	4.5V DC	TK1-4.5V	TK1-L-4.5V	TK1-L2-4.5V
	5V DC	TK1-5V	TK1-L-5V	TK1-L2-5V
	6V DC	TK1-6V	TK1-L-6V	TK1-L2-6V
	9V DC	TK1-9V	TK1-L-9V	TK1-L2-9V
	12V DC	TK1-12V	TK1-L-12V	TK1-L2-12V
	24V DC	TK1-24V	TK1-L-24V	TK1-L2-24V

Standard packing: Tube: 50 pcs.; Case: 1,000 pcs.

2) Self-clinching terminal

Contact arrangement	Nominal coil voltage	Single side stable	1 coil latching	2 coil latching
		Part No.	Part No.	Part No.
1 Form C	1.5V DC	TK1-H-1.5V	TK1-L-H-1.5V	TK1-L2-H-1.5V
	3V DC	TK1-H-3V	TK1-L-H-3V	TK1-L2-H-3V
	4.5V DC	TK1-H-4.5V	TK1-L-H-4.5V	TK1-L2-H-4.5V
	5V DC	TK1-H-5V	TK1-L-H-5V	TK1-L2-H-5V
	6V DC	TK1-H-6V	TK1-L-H-6V	TK1-L2-H-6V
	9V DC	TK1-H-9V	TK1-L-H-9V	TK1-L2-H-9V
	12V DC	TK1-H-12V	TK1-L-H-12V	TK1-L2-H-12V
	24V DC	TK1-H-24V	TK1-L-H-24V	TK1-L2-H-24V

Standard packing: Tube: 50 pcs.; Case: 1,000 pcs.

RATING

1. Coil data

1) Single side stable

Nominal coil voltage	Pick-up voltage (at 20°C 68°F)	Drop-out voltage (at 20°C 68°F)	Nominal operating current [±10%] (at 20°C 68°F)	Coil resistance [±10%] (at 20°C 68°F)	Nominal operating power	Max. applied voltage (at 20°C 68°F)
1.5V DC	75%V or less of nominal voltage* (Initial)	10%V or more of nominal voltage* (Initial)	93.8mA	16Ω	140mW	150%V of nominal voltage
3V DC			46.7mA	64.3Ω		
4.5V DC			31mA	145Ω		
5V DC			28.1mA	178Ω		
6V DC			23.3mA	257Ω		
9V DC			15.5mA	579Ω		
12V DC			11.7mA	1,028Ω		
24V DC			11.3mA	2,133Ω		

2) 1 coil latching

Nominal coil voltage	Set voltage (at 20°C 68°F)	Reset voltage (at 20°C 68°F)	Nominal operating current [±10%] (at 20°C 68°F)	Coil resistance [±10%] (at 20°C 68°F)	Nominal operating power	Max. applied voltage (at 20°C 68°F)
1.5V DC	75%V or less of nominal voltage* (Initial)	75%V or less of nominal voltage* (Initial)	66.7mA	22.5Ω	100mW	150%V of nominal voltage
3V DC			33.3mA	90Ω		
4.5V DC			22.2mA	202.5Ω		
5V DC			20mA	250Ω		
6V DC			16.7mA	360Ω		
9V DC			11.1mA	810Ω		
12V DC			8.3mA	1,440Ω		
24V DC			6.3mA	3,840Ω		

*Pulse drive (JIS C 5442-1986)

3) 2 coil latching

Nominal coil voltage	Set voltage (at 20°C 68°F)	Reset voltage (at 20°C 68°F)	Nominal operating current [±10%] (at 20°C 68°F)		Coil resistance [±10%] (at 20°C 68°F)		Nominal operating power		Max. applied voltage (at 20°C 68°F)
			Set coil	Reset coil	Set coil	Reset coil	Set coil	Reset coil	
1.5V DC	75%V or less of nominal voltage* (Initial)	75%V or less of nominal voltage* (Initial)	133.9mA	133.9mA	11.2Ω	11.2Ω	200mW	200mW	150%V of nominal voltage
3V DC			66.7mA	66.7mA	45Ω	45Ω			
4.5V DC			44.5mA	44.5mA	101.2Ω	101.2Ω			
5V DC			40mA	40mA	125Ω	125Ω			
6V DC			33.3mA	33.3mA	180Ω	180Ω			
9V DC			22.2mA	22.2mA	405Ω	405Ω			
12V DC			20.8mA	20.8mA	576Ω	576Ω	250mW	250mW	120%V of nominal voltage
24V DC	16.7mA	16.7mA	1,440Ω	1,440Ω	400mW	400mW	110%V of nominal voltage		

*Pulse drive (JIS C 5442-1986)

2. Specifications

Characteristics	Item	Specifications	
Contact	Arrangement	1 Form C	
	Initial contact resistance, max.	Max. 50 mΩ (By voltage drop 6 V DC 1A)	
	Contact material	Ag+Au clad	
Rating	Nominal switching capacity	2 A 30 V DC (resistive load)	
	Max. switching power	60 W (DC) (resistive load)	
	Max. switching voltage	220 V DC	
	Max. switching current	2 A	
	Min. switching capacity (Reference value)*1	10μA 10mV DC	
	Nominal operating power	Single side stable 1 coil latching 2 coil latching	140 mW (1.5 to 12 V DC), 270 mW (24 V DC) 100 mW (1.5 to 12 V DC), 150 mW (24 V DC) 200 mW (1.5 to 9 V DC), 250 mW (12 V DC), 400 mW (24 V DC)
Electrical characteristics	Insulation resistance (Initial)	Min. 1,000MΩ (at 500V DC) Measurement at same location as "Initial breakdown voltage" section.	
	Breakdown voltage (Initial)	Between open contacts	750 Vrms for 1 min. (Detection current: 10 mA)
		Between contact and coil	1,500 Vrms for 1 min. (Detection current: 10 mA)
	Surge breakdown voltage (Initial)	Between open contacts	1,500 V (10×160μs) (FCC Part 68)
		Between contacts and coil	2,500 V (2×10μs) (Telcordia)
	Temperature rise (at 20°C 68°F)		Max. 50°C (By resistive method, nominal coil voltage applied to the coil; contact carrying current: 2A.)
Operate time [Set time] (at 20°C 68°F)		Max. 3 ms [Max. 3 ms] (Nominal coil voltage applied to the coil, excluding contact bounce time.)	
Release time [Reset time] (at 20°C 68°F)		Max. 2 ms [Max. 3 ms] (Nominal coil voltage applied to the coil, excluding contact bounce time.) (without diode)	
Mechanical characteristics	Shock resistance	Functional	Min. 750 m/s ² (Half-wave pulse of sine wave: 6 ms; detection time: 10μs.)
		Destructive	Min. 1,000 m/s ² (Half-wave pulse of sine wave: 6 ms.)
	Vibration resistance	Functional	10 to 55 Hz at double amplitude of 3.3 mm (Detection time: 10μs.)
		Destructive	10 to 55 Hz at double amplitude of 5 mm
Expected life	Mechanical	Min. 10 ⁸ (Single side stable), Min. 5×10 ⁷ (1 or 2 coil latching) (at 180 cpm)	
	Electrical	Min. 10 ⁵ (2 A 30 V DC resistive) (at 20 cpm)	
Conditions	Conditions for operation, transport and storage*2	Ambient temperature: -40°C to 85°C -40°F to 185°F*3; Humidity: 5 to 85% R.H. (Not freezing and condensing at low temperature)	
	Max. operating speed (at rated load)	20 cpm	
Unit weight		Approx. 1 g .035 oz.	

Notes: *1 This value can change due to the switching frequency, environmental conditions, and desired reliability level, therefore it is recommended to check this with the actual load. (SX relays are available for low level load switching [10V DC, 10mA max. level])

*2 Refer to 6. Conditions for operation, transport and storage mentioned in [AMBIENT ENVIRONMENT \(p. 19, Relay Technical Information\)](#).

*3 The maximum ambient temperature allows for coil temperature rise at maximum allowable coil voltage.

As for the applicable range of continuous carrying current against temperature, please refer to "Maximum value of continuous carrying current" chart. (Page 4)

REFERENCE DATA

1. Maximum value of continuous carrying current

Test conditions:
Coil applied voltage: 110% of rated voltage
Continuous carrying current: 1,000 hours

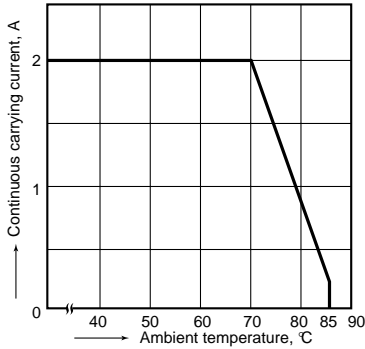

2. Maximum switching capacity

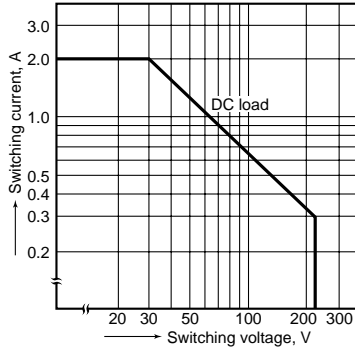

3. Life curve

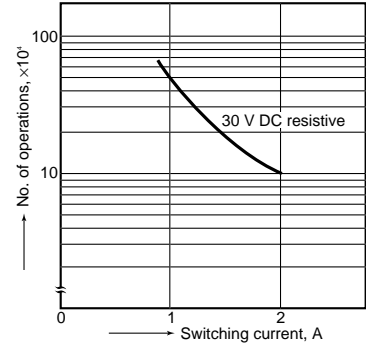

4. Mechanical life

Tested sample: TK1-12V, 8 pcs.
Switching frequency: 30 Hz

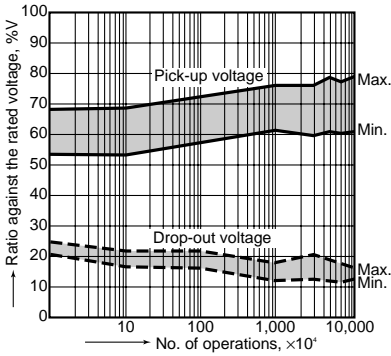

5. Electrical life (DC load)

Tested sample: TK1-12V, 10 pcs.
Condition: 2 A 30 V DC resistive load, 20 cpm
Change of pick-up and drop-out voltage

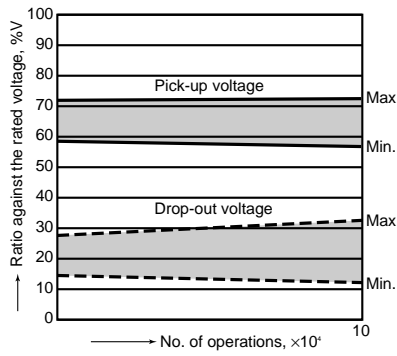

Change of contact resistance

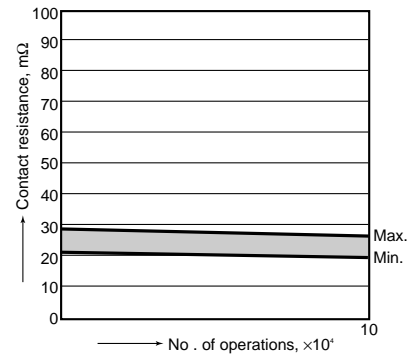

6.-(1) Coil temperature rise

Tested sample: TK1-12V, 6 pcs.
Measured portion: Inside the coil
Ambient temperature: 25°C 77°F

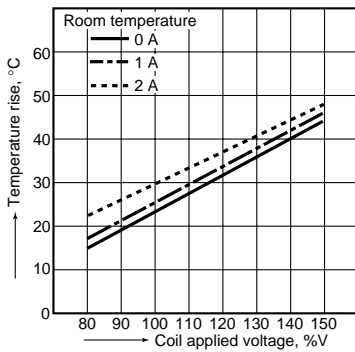

6.-(2) Coil temperature rise

Tested sample: TK1-12V, 6 pcs.
Measured portion: Inside the coil
Ambient temperature: 70°C 158°F

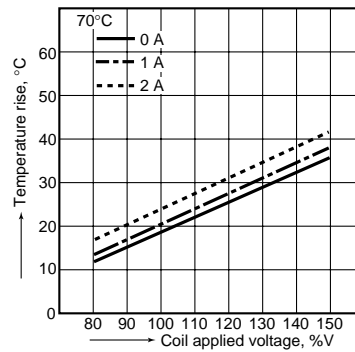

7.-(1) Operate/release time characteristics

Tested sample: TK1-5 V, 50 pcs.
<Without diode>

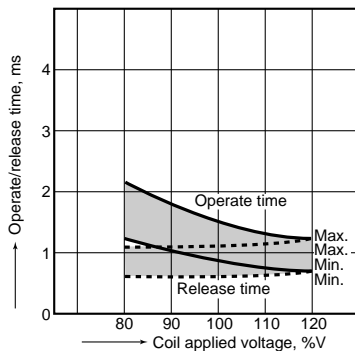

7.-(2) Operate/release time characteristics

Tested sample: TK1-5 V, 50 pcs.
<With diode>

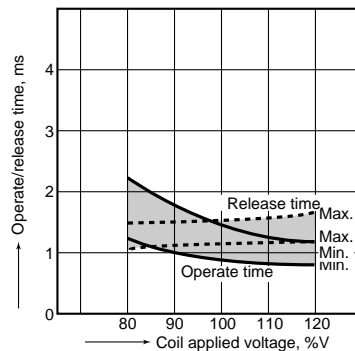

8. Ambient temperature characteristics

Tested sample: TK1-12V, 5 pcs.

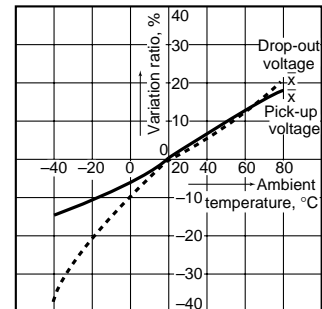

9.-(1) High-frequency characteristics (Isolation)

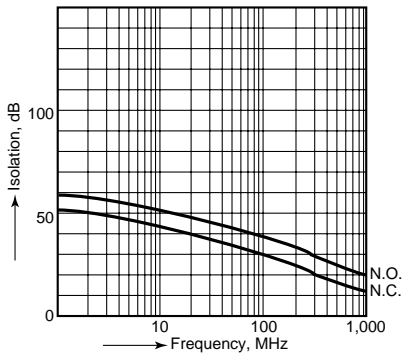

9.-(2) High-frequency characteristics (Insertion loss)

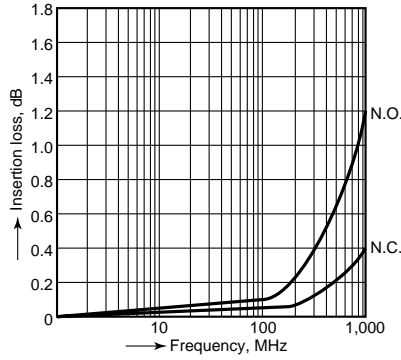

10. Malfunctional shock

Tested sample: TK1-12V, 6 pcs. (single side stable); TK1-L2-12V, 6 pcs. (latching)

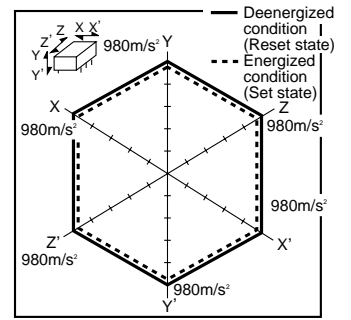

11.-(1) Influence of adjacent mounting

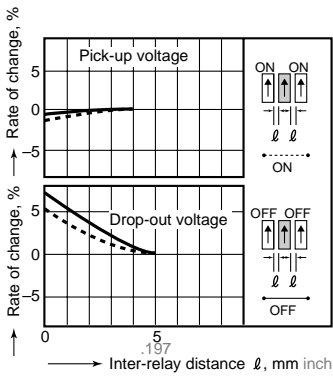

11.-(2) Influence of adjacent mounting

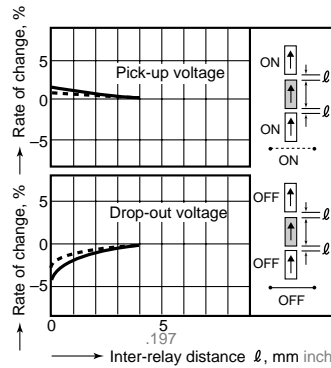

12. Actual load test (35 mA 48 V DC wire spring relay load)

Circuit

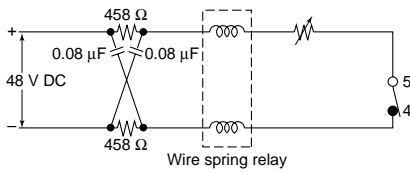

Change of pick-up and drop-out voltage

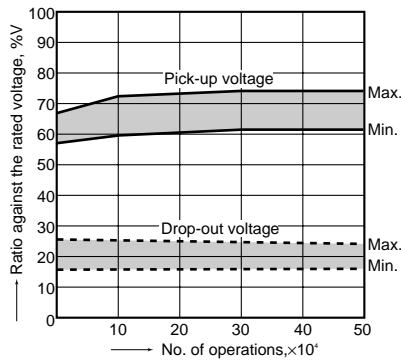

Change of contact resistance

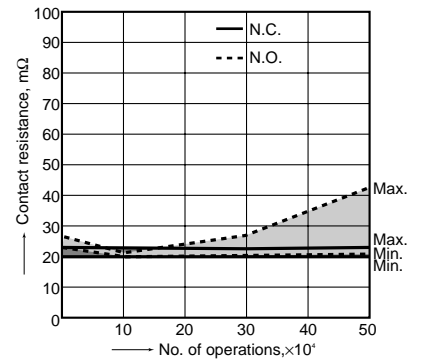

DIMENSIONS (mm inch)



External dimensions
Standard PC board terminal

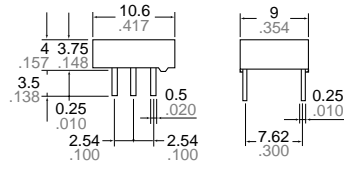

PC board pattern (Bottom view)

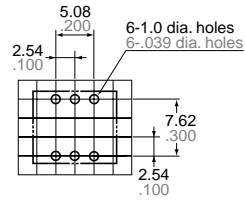

Tolerance: $\pm 0.1 \pm 0.004$

Self-clinching terminal

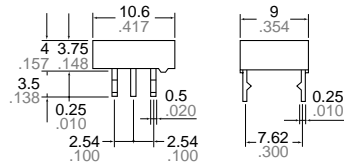

General tolerance: $\pm 0.3 \pm 0.012$

Schematic (Bottom view)

Single side stable

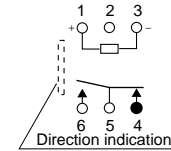

(Deenergized condition)

1-coil latching

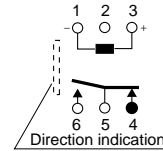

(Reset condition)

2-coil latching

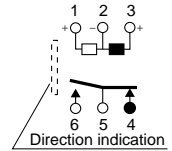

(Reset condition)

NOTES

1. Packing style

The relay is packed in a tube with the relay orientation mark on the left side, as shown in the figure below.

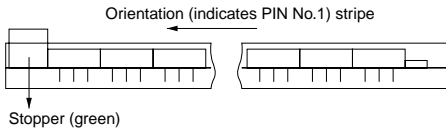

2. Automatic insertion

To maintain the internal function of the relay, the chucking pressure should not exceed the values below.

Chucking pressure in the direction A:

9.8 N {1 kgf} or less

Chucking pressure in the direction B:

29.4 N {3 kgf} or less

Chucking pressure in the direction C:

9.8 N {1 kgf} or less

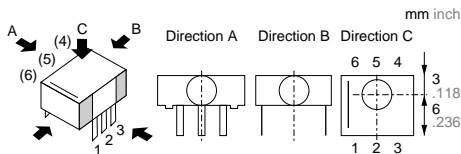

Please chuck the portion.

Avoid chucking the center of the relay.

In addition, excessive chucking pressure to the pinpoint of the relay should be avoided.

For Cautions for Use, see [Relay Technical Information](#).

单击下面可查看定价，库存，交付和生命周期等信息

[>>Panasonic\(松下\)](#)