

Date : November 29.2017

To: PIDSA

PRODUCT REFERENCE DATA SHEET

Product Description : ZNR SURGE ABSORBER
Product Part Number : ERZV20R (= 201 to 511)

Deveice Solutions Business Division
Automotive & Industrial Systems Company
Panasonic Corporation

1037-2 Kamiosatsu, Chitose City,
Hokkaido 066-8502 Japan

Phone : +81-123-23-8194

Prepared by : Engineering Section

Contact Person :

Signature



Name(Print) : Masayoshi Kanazawa

Title : Charge

Check by :

Signature

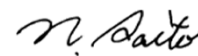

Name(Print) : Naoki Saito

Title : Engineer

Panasonic

CLASSIFICATION	PRODUCT REFERENCE DATA SHEET	
SUBJECT	ZNR SURGE ABSORBER V-SERIES (Bulk Type) ERZV20R271	1 - 20
		DATE November 1, 2016

[HANDLING PRECAUTIONS]

⚠ Precautions for Safety

In the case that a ZNR surge absorber (Type D, Series V) (hereafter referred to as the ZNR ,or product name) is used if an abnormality takes place because of peripheral conditions of the ZNR (material, environments, power source conditions, circuit conditions, etc. in equipment design), fire, electric shock, burn, or product failure may be occur.

The precautions for this product are described below, understand the content thoroughly before usage.

For more questions, contact us.

1. ⚠ Precautions to be strictly observe

1.1 Confirmation of performance ratings

Use the ZNR within its rated range of performance such as the Max. allowable voltage, withstanding surge current, withstanding energy, impulse life (surge life), average pulse power, and operating temperature range. If used outside the range, the ZNR can be degrade and have element fracture, which may result in smoking and ignition.

1.2 To avoid accidents due to unexpected phenomena, take the following measures

- 1) In the event of fracture of the ZNR, its pieces may scatter ; hence, put the case or cover of the set product in place.
- 2) Do not install the ZNR near combustibile substances (polyvinyl chloride wires, resin moldings, etc.).
If it is difficult to do, install a nonflammable cover.
- 3) Across-the-line use
When the ZNR is used across a line, put a current fuse in series with the ZNR.
(Refer to Item 2.1.1 (4) and Table 1.)
- 4) Use between line to ground
 - (1) In the case that the ZNR is used between a line to the ground, the short-circuit of the ZNR may not blow the current fuse because of grounding resistance, which may cause smoking and ignition of the ZNR's exterior resin. As the measure against it, install an earth leakage breaker on the power supply side of the ZNR position. If no earth leakage breaker is installed, use a thermal fuse together with a current fuse in series.
(Refer to Table 1.)
 - (2) In the case that the ZNR is used between a live part and metal case, a electric shock may develop at a short circuit of the ZNR ; hence, ground the metal case to the ground or keep it from the human body.

2. Application notes

2.1 Pay attention to the following items to avoid the shortened life and failure of the ZNR

- 1) Circuit conditions
 - (1) Select a ZNR of which the maximum voltage including fluctuations in source voltage allows for the maximum permissible circuit voltage. (Refer to Table 1.)
 - (2) In cases that surges are intermittently applied at short intervals (for example, in the case that the voltage of the noise simulator test is impressed etc.), do not cause them to exceed the ZNR's rated pulse power.
 - (3) Select a ZNR recommended in Table 1.
- <1> Across the Line (Line to Line) use
If possible, use a Part No. marked with * incase of voltage temporarily rises load unbalance of separately-wired loads, short between hot and neutral-line, open of neutral line in single-phase-three-wired system, and due to resonance at switching for a capacitive, inductive load.

CLASSIFICATION	PRODUCT REFERENCE DATA SHEET	
SUBJECT	ZNR SURGE ABSORBER V-SERIES (Bulk Type) ERZV20R271	
		2 - 20

<2> Used between line to ground

Use a different Part No. from "Across-the-line use" as table 1, because of raising voltage in case of "Line to Ground Fault".

Use a part No. marked with ** in table 1, in case of the insulation resistance test (500VDC) for equipment.

When using a part of the varistor voltage that the insulation efficiency examination can not be cleared, there is a case where the surge absorber can be done by removing it from the circuit depending on the circuit condition (Refer examination of Japan Domestic Safety Regulations).

Use a Part No. marked with *** in table 1, in case of the withstanding voltage test (1000VAC or 1200VAC) for equipment.

(4) Concerning current fuse

<1> We recommended to selecting a ZNR and the rated current of a current fuse as follows.

Finally, please be sure that there is no danger if the ZNR mounted on equipment breaks.

Series	V05	V07	V09	V10	V14	V20
Std. Bulk P/N	ERZV05++++	ERZV07++++	ERZV09++++	ERZV10++++	ERZV14++++	ERZV20++++
Std. Taped P/N	ERZV+5++++	ERZV+7++++	ERZV+9++++	ERZV+A++++	ERZV+E++++	————
Fuse rated current	3A max	5A max	7A max	7A max	10A max	10A max

* Fuses shall use rated voltages appropriate for circuits.

* Refer to Item (2.1 5) " CSA safety standard approved fuse" as well.

<2> The recommended fuse position is shown in table 1, "Example of ZNR application", however, if the load current of protected equipment is larger than that of the above recommended fuse rated current, install a current fuse at the position shown below.

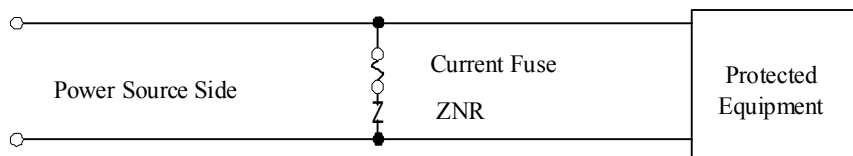

(5) Concerning thermal fuse

Set a thermal fuse to get high thermal conductivity with ZNR.

Note/Revision

CLASSIFICATION	PRODUCT REFERENCE DATA SHEET	
SUBJECT	ZNR SURGE ABSORBER V-SERIES (Bulk Type) ERZV20R271	
		3 - 20

Table 1 Example of ZNR application

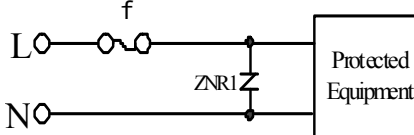
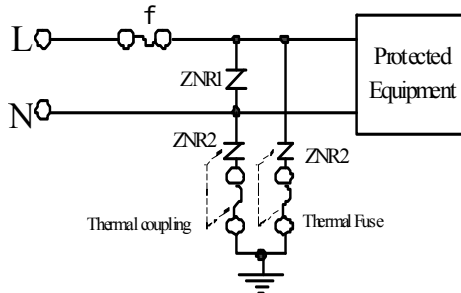
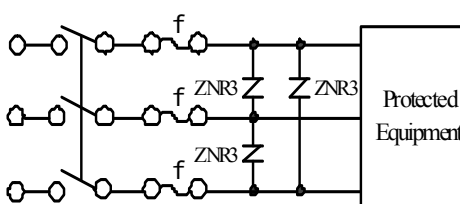
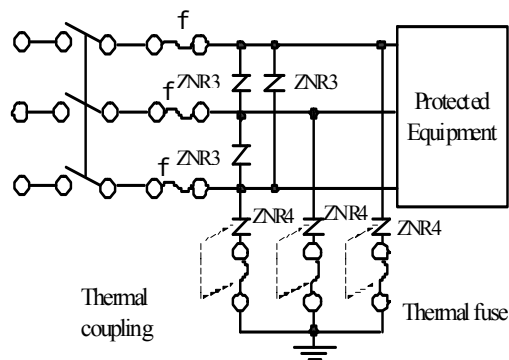
Connection example	Measure against across-the-line surge			Measure against surge across the line and between the line and ground		
	DC/AC single-phase			DC/AC single-phase		
	 <p style="text-align: center;">f: fuse</p>			 <p style="text-align: center;">f: fuse</p>		
	AC 3-phase			AC 3-phase		
 <p style="text-align: center;">f: fuse</p>			 <p style="text-align: center;">f: fuse</p>			
Example of rating selection	Across the Line (Line to Line) use			Line to Ground use		
	ZNR	Source voltage	Nominal varistor voltage	ZNR	Source voltage	Nominal varistor voltage
	ZNR1 ZNR3	AC100V	201 to 361*	ZNR2 ZNR4	AC100V ~ AC220V	471
		AC120V	241 to 431*			511
		AC200V	471 to 621*			621*
		AC220V	471 to 621*		821 and more**	
		AC240V	511, 621*		182***	
		AC380V	821		511	
			AC230V ~ AC240V	621*		
			AC380V	821 and more**		
				182***		
				112**		
				182***		

Note/Revision

CLASSIFICATION	PRODUCT REFERENCE DATA SHEET	
SUBJECT	ZNR SURGE ABSORBER V-SERIES (Bulk Type) ERZV20R271	
		4 - 20

2) Operating environments

- (1) The ZNR is designed and manufactured for application in general purpose electronic devices.
The ZNR shall not be exposed to the weather, except for usage inside unit.
- (2) Do not use the ZNR in places exposed to temperatures beyond the operating temperature range, such as places exposed to sunlight and vicinities of heating equipment.
- (3) Do not use the ZNR in places exposed to high temperatures and high humidity, such as places exposed directly to rain, wind, dew condensation, and vapor.
- (4) Do not use the ZNR in dusty and salty places and atmospheres polluted by corrosive gases.

3) Processing conditions

- (1) Do not wash the ZNR by such solvents (thinner, acetone, etc.) as its exterior resin deteriorates.
- (2) Do not apply a strong vibration, shock (by falling, etc.) to the ZNR, cracking to its exterior resin and element may occur.
- (3) When coating the ZNR with resin (including molding), do not use such resin.
- (4) Do not bend the ZNR lead wires at the position close to its ZNR exterior resin, or apply external force to the position.
- (5) When soldering the ZNR lead wires, follow the recommended condition and do not melt the solder and insulating materials constituting the ZNR.

Type D	Soldering Method	Recommended Condition	Attention
	Flow soldering	260deg.C, within 10sec	Type D is not Reflow soldering object part.

*1 When using at the thing except the condition that it is possible to suggest to the above, confirm that there is not a problem.

The limit of the repair be once and go in solder temperature within 400 and moreover within 5 seconds.

*2 Profile be careful because there is a margin of error in the way of measuring.

*3 The temperature depend on the size and the package density of the substrate.

Therefore, confirm every kind of the substrate.

- Soldering temperature-time profile to recommend

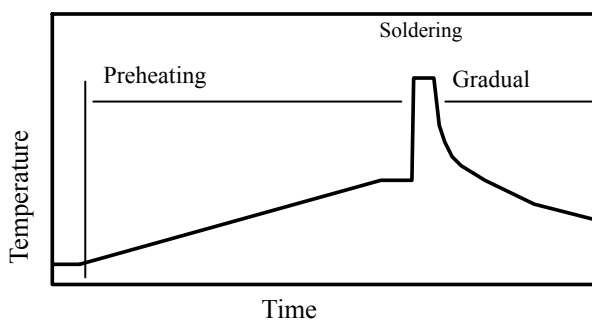

Preheating	The normal to 130deg.C	max.120s
Soldering	max.260deg.C	max.10s
Gradual cooling	Gradual cooling	

Note/Revision

CLASSIFICATION	PRODUCT REFERENCE DATA SHEET	
SUBJECT	ZNR SURGE ABSORBER V-SERIES (Bulk Type) ERZV20R271	
		5 - 20

4) Long-term storage

- (1) Do not store the ZNR under high temperature and high humidity. Store it at temperature up to 40 degree-C and at humidity below 75%RH, and use it within two years.
Before using the ZNR that has been stored for a long period (two year or longer), confirm the solderability.
- (2) Avoid atmospheres full of corrosive gases (hydrogen sulfide, sulfurous acid, chlorine, ammonia, etc.).
- (3) Avoid direct sunlight and dew condensation.

5) Application notes for CSA

- (1) CSA regulate "Maximum Rating of Fuse" for using ZNR to "Audio, Video and Similar Electronic Equipment" as below.

Maximum Peak Current 8/20 μ s, 1 time (A)	Maximum Rating of Fuse (A)
500 and under	3
Over 500 to 2000 and under	5
Over 2000 to 6000 and under	10
Over 6000	Not specified.

- (2) "Rated Voltages" are specified for UL/CSA recognized components besides Maximum Allowable Voltage because of conforming to the Standby Current specified in safety standards.
In case of making an application to UL/CSA approval for equipment with ZNR, the maximum AC operating voltage of equipment shall be lower than the ZNR Rated Voltage.

3. Notices

- 3.1 In cases that the ZNR is used in equipment (aerospace equipment, medical equipment, etc.) requiring extremely high reliability, ask us for selection of Part No., and protection coordination, etc. in advance.**
- 3.2 There is possibility that the ZNR will unexpectedly smoke or ignite because of abnormal rise of the circuit voltage and invasion of excessive surge. To prevent that accident from spreading over the equipment and not to expand the damage, use multiplex protection such as the adoption of flame-retardant materials for housing parts and structural parts.**
- 3.3 Package marking includes the product number, quantity, and country of origin.
As a rule, country of origin should be indicated in English.**

4. Substances of this product

- 4.1 This product not been manufactured with any ozone depleting chemical controlled under the Montreal Protocol.
- 4.2 This product comply with RoHS(Restriction of the use of certain Hazardous Substance in electrical and electronic equipment) Directive(2011/65/EU).
- 4.3 All the materials used in this part are registered material under the Law Concerning the Examination and Regulation of Manufacture, etc. of Chemical Substance

Note/Revision

CLASSIFICATION	PRODUCT REFERENCE DATA SHEET	
SUBJECT	ZNR SURGE ABSORBER V-SERIES (Bulk Type) ERZV20R271	
		6 - 20

[SPECIFICATIONS]

1. Scope, Part Numbers, Construction

1.1 Scope

This specification applies to the ZNR Surge Absorbers (Bulk Type).

1.2 Part Numbers

Explanation of Part Numbers

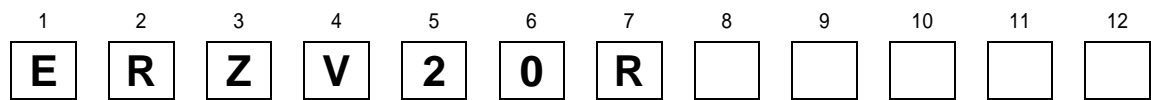

Product Code

Series

Design no.

V20	V20 series
-----	------------

Lead Configuration	
R	W:7.5mm

Nominal Varistor Voltage
The first two digits are significant figures and the third one denotes the number of zeros following.

Note/Revision

CLASSIFICATION	PRODUCT REFERENCE DATA SHEET	
SUBJECT	ZNR SURGE ABSORBER V-SERIES (Bulk Type) ERZV20R271	7 - 20

1.3 Construction

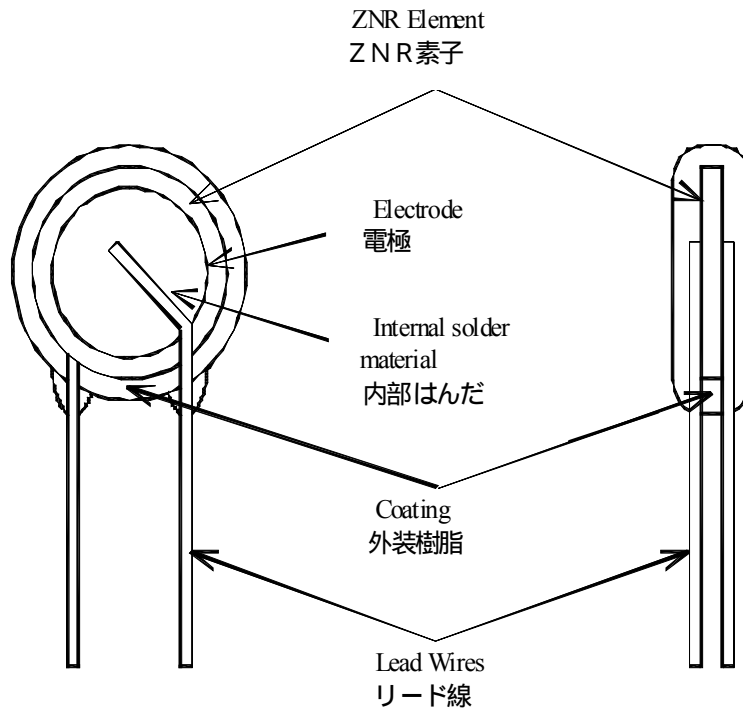

Item 部品名	Material 材質
ZNR Element ZNR素子	ZnO Ceramics etc. 酸化亜鉛 他
Electrode 電極	Silver 銀
Internal solder material 内部はんだ	Sn-Ag-Cu
Coating 外装樹脂	Epoxy Resin (UL94 V-0 approved) エポキシ樹脂 (UL94 V-0 認定品)
Lead Wires リード線	Tin(Sn100%) Plated Copper 錫(Sn100%)メッキ銅線
series :V20 シリーズ :V20	

Note/Revision

CLASSIFICATION	PRODUCT REFERENCE DATA SHEET	
SUBJECT	ZNR SURGE ABSORBER V-SERIES (Bulk Type) ERZV20R271	
		8 - 20

2. Appearance, Dimensions

2.1 Appearance

Without dirt and crack, marking should be clear.

2.2 Dimensions

Refer to Figure 1.1 to 1.2 and table 1.1 to 1.2.

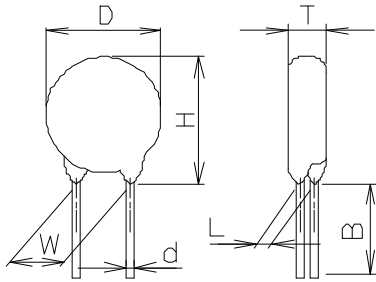

Fig. 1.1

Straight Lead Type

Part No :ERZV20R271

Note/Revision

CLASSIFICATION	PRODUCT REFERENCE DATA SHEET	
SUBJECT	ZNR SURGE ABSORBER V-SERIES (Bulk Type) ERZV20R271	
		9 - 20

3. Electrical Requirements

Listed below of Specifications, Test Specifications, and Test Methods.
Individual specifications is in the table 2

Characteristics		Specifications		Test Specifications
3.1	Max. allowable voltage	AC : Table 2 DC : Table 2		
3.2	Rated voltage	AC : Table 2		
3.3	Rated wattage	Table 2		
3.4	Varistor voltage	V1 Table 2		Measuring current : 1mA DC
3.5	Clamping voltage	Table 2		Measuring current : Table 2 Current Waveform : 8/20 μ s
3.6	Maximum peak current (Withstanding surge current)	1 pulse	Table 2	Impulse : 8/20 μ s
		2 pulses	Table 2	Impulse : 8/20 μ s at interval of 5 min.
3.7	Maximum energy	Table 2		Impulse : 2ms , 1 pulse
		Table 2		Impulse : 10/1000 μ s, 1 pulse
3.8	Temperature coefficient of varistor voltage	0 ~ - 0.05%/		Measured voltage : V_1 Temp. range : +25 to +85deg.C
3.9	Capacitance	Table 2		Measuring frequency : 1kHz 1MHz (below 100pF)
3.10	Dielectric loss	Table 2		Measuring frequency : 1kHz 1MHz (below 100pF)
3.11	Withstand voltage	No breakdown		Applied voltage : Table 2
				Time : 1 min.

Note/Revision

CLASSIFICATION	PRODUCT REFERENCE DATA SHEET	
SUBJECT	ZNR SURGE ABSORBER V-SERIES (Bulk Type) ERZV20R271	
		10 - 20

3.Electrical Test Methods		
Characteristics		Test Methods/Description
	Standard test condition	Environmental conditions under which every measuring is done without doubt on the measuring results. Unless specially, specified, temperature, relative humidity are 5deg.C to 35deg.C, 45 to 85%RH respectively.
3. 1	Maximum allowable voltage	The maximum Sine wave voltage (rms) that can be applied continuously or maximum DC voltage in the specified environmental temperature range.
3. 2	Rated voltage	The maximum Sine wave voltage (rms) that can be applied continuously in CSA recognized equipment.
3. 3	Rated wattage	The maximum power to be loaded with in the specified environmental temperature range.
3. 4	Varistor voltage	Voltage between both terminals of ZNR measured when CmA of DC current is applied under standard conditions. It is called Vc or VcmA. Measuring the varistor voltage should be made promptly to avoid heat affection.
3. 5	Clamping voltage	The maximum voltage between two terminals with the specified standard impulse current (8/20 μ s).
3. 6	Maximum peak current (Withstanding surge current)	The maximum current within the varistor voltage change of $\pm 10\%$ with the standard impulse (8/20 μ s) applied by the specified condition.
3. 7	Maximum energy	The maximum energy within the varistor voltage change of $\pm 10\%$ when the specified impulse is applied.
3. 8	Temperature coefficient of varistor voltage	Coefficient indicating dependency of varistor voltage on specified temperature.
3. 9	Capacitance	Capacitance shall be measured at 1kHz $\pm 10\%$, 1Vrms max. (1MHz $\pm 10\%$ below 100pF), 0V bias and 20 ± 2 deg.C.
3.10	Dielectric loss	Dielectric loss tangent shall be measured at 1kHz $\pm 10\%$, 1Vrms max. (1MHz $\pm 10\%$ below 100pF), 0V bias and 20 ± 2 deg.C.
3.11	Withstand voltage	The specified voltage shall be applied both terminals of the specimen connected together and metal foil closely wrapped round its body for 1 minute.

Note/Revision

CLASSIFICATION	PRODUCT REFERENCE DATA SHEET	
SUBJECT	ZNR SURGE ABSORBER V-SERIES (Bulk Type) ERZV20R271	
		11 - 20

4. Mechanical Requirements

Listed below of Specifications, Test Specifications, and Test Methods.

4. Mechanical Requirements		
Characteristics	Specifications	Test Specifications
4.1 Robustness of terminations (Tensile)	No outstanding damage	V20 series : 19.6N, 10s
4.2 Robustness of terminations (Bending)	No outstanding damage	V20 series : 9.8N
4.3 Vibration	No outstanding damage	Frequency : 10 to 55Hz Amplitude : 0.75mm Time : each 2 hours
4.4 Solderability	Minimum 95% of the terminals should be covered with solder uniformly	Solder temp. : 235±5 Immersed time : 2±0.5s
4.5 Resistance to soldering heat	$\Delta V_I \pm 5\%$	Solder temp. : 260±5 Immersed time : 10±1s

4. Mechanical Test Methods		
Characteristics	Test Methods/Description	
4.1 Robustness of terminations (Tensile)	After gradually applying the specified load and keeping the unit fixed for ten seconds, the terminal shall be visually examined for any damage.	
4.2 Robustness of terminations (Bending)	The unit shall be secured with its terminals kept vertical and the specified load is applied, gradually bent by 90° in one direction, back to the original position, then 90° in the opposite direction, and again back to the original position. The damage of the terminals is visually examined.	
4.3 Vibration	After repeatedly applying a single harmonic vibration (amplitude ; 0.75mm ; double amplitude ; 1.5mm with 1 minute vibration frequency cycles(10Hz to 55Hz to 10Hz) to each of three perpendicular directions for 2 hours. The varistor shall then be visually examined.	
4.4 Solderability	After dipping the terminals to a depth of about 3mm from the body, in the melted solder of 235±5 for 2±0.5 seconds, the terminals are visually examined.	
4.5 Resistance to Soldering Heat	After each lead shall be dipped into a solder bath having a temperature 260±5 to a point 2.0 ~ 2.5mm from the body of the unit, be held there for specified time, and then be stored at room temperature and humidity for 1 to 2 hour. The change of Vc and mechanical damages are examined.	
Note : Varistor Voltage change of forward direction shall be measured in the test of uni-pole surge life and DC load life.		

Note/Revision

CLASSIFICATION	PRODUCT REFERENCE DATA SHEET	
SUBJECT	ZNR SURGE ABSORBER V-SERIES (Bulk Type) ERZV20R271	
		12 - 20

5. Environmental Requirements

Listed below of Specifications, Test Specifications, and Test Methods.
Individual specifications is in the table 2

5. Environmental Requirements																		
5.1	High temperature storage (Dry heat)	$\Delta V1 \pm 5\%$	Ambient temp. : 125 ± 2 Time : 1000h															
5.2	Damp heat	$\Delta V1 \pm 5\%$	Ambient condition : 40 ± 2 , 90 to 95%RH Time : 1000h															
5.3	Low temperature storage (Cold)	$\Delta V1 \pm 5\%$	Ambient temp. : -40 ± 2 Time : 1000h															
5.4	Heat cycle	$\Delta V1 \pm 5\%$ No outstanding damage	<table border="1"> <thead> <tr> <th>Step</th> <th>Temp.</th> <th>Period</th> </tr> </thead> <tbody> <tr> <td>1</td> <td>-40 ± 3</td> <td>30min.</td> </tr> <tr> <td>2</td> <td>Room Temp.</td> <td>15min.</td> </tr> <tr> <td>3</td> <td>$+125 \pm 2$</td> <td>30min.</td> </tr> <tr> <td>4</td> <td>Room Temp.</td> <td>15min.</td> </tr> </tbody> </table> <p style="text-align: center;">5cycles</p>	Step	Temp.	Period	1	-40 ± 3	30min.	2	Room Temp.	15min.	3	$+125 \pm 2$	30min.	4	Room Temp.	15min.
Step	Temp.	Period																
1	-40 ± 3	30min.																
2	Room Temp.	15min.																
3	$+125 \pm 2$	30min.																
4	Room Temp.	15min.																
5.5	High temperature load (Dry heat load)	$\Delta V1 \pm 10\%$	Ambient temp. : 85 ± 2 Time : 1000h															
5.6	Damp heat load	$\Delta V1 \pm 10\%$	Ambient condition : 40 ± 2 , 90 to 95%RH Time : 1000h															
5.7	Impulse life I (Surge life I)	$\Delta V1 \pm 10\%$ at listed table 2	Impulse : $8/20\mu s$ Applied condition : 10^4 times by interval 10s															
5.8	Impulse life (Surge life)	$\Delta V1 \pm 10\%$ at listed table 2	Impulse : $8/20\mu s$ Applied condition : 10^5 times by interval 10s															
Operating Temperature Range		-40 to +85																
Storage Temperature Range		-40 to +125																

Note/Revision

CLASSIFICATION	PRODUCT REFERENCE DATA SHEET	
SUBJECT	ZNR SURGE ABSORBER V-SERIES (Bulk Type) ERZV20R271	
		13 - 20

5. Environmental Test Methods		
5.1	High temperature storage (Dry heat)	The specimen shall be subjected to 125 ± 2 for 1000 hours in a thermostatic bath without load and then stored at room temperature and humidity for 1 to 2 hours. Thereafter, the change of Vc shall be measured.
5.2	Damp heat	The specimen shall be subjected to 40 ± 2 , 90 to 95%RH for 1000 hours without load and then stored at room temperature and humidity for 1 to 2 hours. Thereafter, the change of Vc shall be measured.
5.3	Low temperature storage (Cold)	The specimen shall be subjected to -40 ± 2 without load for 1000 hours and then stored at room temperature for 1 to 2 hours. Thereafter, the change of Vc shall be measured.
5.4	Heat cycle	The temperature cycling shall be repeated 5 times and stored at room temperature and humidity for 1 to 2 hours. The change of Vc as well as mechanical damage shall be examined.
5.5	High temperature load (Dry heat load)	After being continuously applied the maximum allowable voltage at 85 ± 2 for 1000 hours, the specimen shall be stored at room temperature and humidity for 1 to 2 hours. Thereafter, the change of Vc shall be measured.
5.6	Damp heat load	The specimen shall be subjected to 40 ± 2 , 90 to 95%RH and the maximum allowable voltage for 1000 hours and then stored at room temperature and humidity for 1 to 2 hours. Thereafter, the change of Vc shall be measured.
5.7	Impulse life I (Surge life I)	After the specified impulse is applied 10000 times continuously with the interval 10 seconds at room temperature, the specimen shall be stored at room temperature and humidity for 1 to 2 hours. Thereafter, the change of Vc shall be measured.
5.8	Impulse life II (Surge life II)	After the specified impulse is applied 100000 times continuously with the interval 10 seconds at room temperature, the specimen shall be stored at room temperature and humidity for 1 to 2 hours. Thereafter, the change of Vc shall be measured.
Note : Varistor Voltage change of forward direction shall be measured in the test of uni-pole surge life and DC load life.		

6. Marking Contents

Refer to table 3

Individual specifications of Dimensions and Electrical Requirements and Environmental Requirements are indicated below.

Dimensions : Table 1

Electrical Requirements : Table 2

Environmental Requirements : Table 2

Marking Contents : Table 3

Note/Revision

CLASSIFICATION	PRODUCT REFERENCE DATA SHEET	
SUBJECT	ZNR SURGE ABSORBER V-SERIES (Bulk Type) ERZV20R271	
		14 - 20

Table 1 Series V20 Straight Lead Type

品番 Part No.	付図番号 Fig. No.	D max. (mm)	H max. (mm)	T max. (mm)	W +/-1.0 (mm)	L +/-1.0 (mm)	B min. (mm)	C +/-0.4 (mm)	Φd +/- (mm)	¹⁾ 単重 Approx. (g)
ERZV20R271	付図 1.1 Fig. 1.1	21.5	24.5	5.6	7.5	2.5	20.0	-	0.8 +0.08 -0.05	4.4

¹⁾参考値 Typical

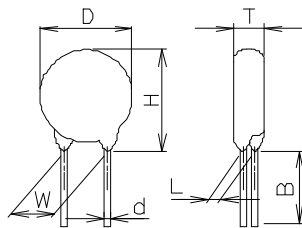

Fig 1.1 Straight Lead Type

Note/Revision

CLASSIFICATION	PRODUCT REFERENCE DATA SHEET	
SUBJECT	ZNR SURGE ABSORBER V-SERIES (Bulk Type) ERZV20R271	
		15 - 20





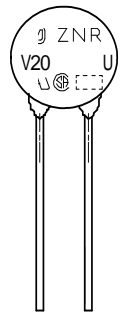



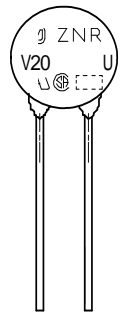



Table 2 Series V20

Part Number	Electrical														Environmental			
	Maximum Allowable Voltage		Rated Voltage	Rated watt-age	Varistor Voltage	Clamping Voltage		Maximum Peak Curent		Maximum Energy		Capaci-tance	Di-electric Loss	With-stand voltage	Impulse Life (Surge Life)			
	ACrms	DC	ACrms			(max.)	1 time	2 times	2ms	10/1000 µs	(max.)	(max.)	(max.)	I	II			
	(V)	(V)	(V)				(W)	(V)								VxA(V)	xA	(A)
ERZV20R201			130	170	118	1.0	185 ~ 225	340	100	10000	7000	100	140	1700	10	1000	250	120
ERZV20R221			140	180	127	1.0	198 ~ 242	360	100	10000	7000	110	155	1600	10	1000	250	120
ERZV20R241			150	200	136	1.0	216 ~ 264	395	100	10000	7000	120	168	1500	10	1000	250	120
ERZV20R271			175	225	159	1.0	247 ~ 303	455	100	10000	7000	135	190	1300	10	1000	250	120
ERZV20R331			210	270	189	1.0	297 ~ 363	545	100	10000	6500	160	228	1100	10	1000	250	120
ERZV20R361			230	300	209	1.0	324 ~ 396	595	100	10000	6500	180	255	1100	10	1500	250	120
ERZV20R391			250	320	227	1.0	351 ~ 429	650	100	10000	6500	195	275	1100	10	1500	250	120
ERZV20R431			275	350	250	1.0	387 ~ 473	710	100	10000	6500	215	303	1000	10	1500	250	120
ERZV20R471			300	385	272	1.0	423 ~ 517	775	100	10000	6500	250	350	900	10	1500	250	120
ERZV20R511			320	410	291	1.0	459 ~ 561	845	100	10000	6500	273	382	800	10	1500	250	120

Note/Revision

CLASSIFICATION	PRODUCT REFERENCE DATA SHEET	
SUBJECT	ZNR SURGE ABSORBER V-SERIES (Bulk Type) ERZV20R271	16 - 20

Table 3 Series V20

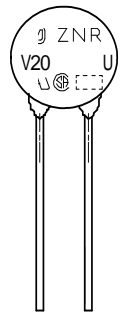
Part Number 品番	Marking Contents 表示の内容	Explanation of the content 内容の説明																																																																																						
		<table border="1"> <tr> <td></td> <td>Trade Mark 製造者識別マーク</td> </tr> <tr> <td>ZNR</td> <td>Product Name 品名</td> </tr> <tr> <td></td> <td></td> </tr> <tr> <td>V20 U</td> <td>Type Name, Abbreviation of Part No. タイプ名, 品番略称 ... Nominal Varistor Voltage 公称バリスタ電圧略称</td> </tr> <tr> <td></td> <td>UL Recognized Component Mark UL 認定マーク</td> </tr> <tr> <td></td> <td>CSA Monogram CSA モノグラム</td> </tr> <tr> <td></td> <td>Factory Identification Marking 工場識別コード</td> </tr> <tr> <td></td> <td> <table border="1"> <tr> <td>None 表記なし</td> <td>... Japan 日本国</td> </tr> <tr> <td>Q</td> <td>... Indonesia インドネシア</td> </tr> </table> </td> </tr> <tr> <td></td> <td></td> <td> <p>Year Code(example) 年コード(例)</p> <table border="1"> <tr> <td>2010</td><td>0</td> <td>2020</td><td>K</td> <td>2030</td><td>0</td> </tr> <tr> <td>2011</td><td>1</td> <td>2021</td><td>A</td> <td>2031</td><td>1</td> </tr> <tr> <td>:</td><td>:</td> <td>:</td><td>:</td> <td>:</td><td>:</td> </tr> <tr> <td>2018</td><td>8</td> <td>2028</td><td>H</td> <td>2038</td><td>8</td> </tr> <tr> <td>2019</td><td>9</td> <td>2029</td><td>J</td> <td>2039</td><td>9</td> </tr> </table> <ul style="list-style-type: none"> When the tens digit of Christian era is even number, an alphabetic character (1:A, 2:B...9:J, 0:K, I is excluded.) shall be used for the abbreviation of end of Christian era. 西暦年の+の位が偶数年は末尾略称に英字(1:A, 2:: B...9:J, 0:K, Iを除く)を使用する。 When the tens digit of Christian era is odd number, a numeric character (End of Christian era) shall be used for the abbreviation of end of Christian era. 西暦年の+の位が奇数年は末尾略称に数字(西暦末尾)を使用する。 </td> </tr> <tr> <td></td> <td></td> <td> <p>Monthly Code 月コード</p> <table border="1"> <tr> <td>Jan.</td><td>1</td> <td>Jul.</td><td>7</td> </tr> <tr> <td>Feb.</td><td>2</td> <td>Aug.</td><td>8</td> </tr> <tr> <td>Mar.</td><td>3</td> <td>Sep.</td><td>9</td> </tr> <tr> <td>Apr.</td><td>4</td> <td>Oct.</td><td>O</td> </tr> <tr> <td>May.</td><td>5</td> <td>Nov.</td><td>N</td> </tr> <tr> <td>Jun.</td><td>6</td> <td>Dec.</td><td>D</td> </tr> </table> </td> </tr> <tr> <td>ERZV20R271</td> <td>  </td> <td></td> </tr> <tr> <td></td> <td>  <p>部品表示の一例 example</p> </td> <td></td> </tr> </table>		Trade Mark 製造者識別マーク	ZNR	Product Name 品名			V20 U	Type Name, Abbreviation of Part No. タイプ名, 品番略称 ... Nominal Varistor Voltage 公称バリスタ電圧略称		UL Recognized Component Mark UL 認定マーク		CSA Monogram CSA モノグラム		Factory Identification Marking 工場識別コード		<table border="1"> <tr> <td>None 表記なし</td> <td>... Japan 日本国</td> </tr> <tr> <td>Q</td> <td>... Indonesia インドネシア</td> </tr> </table>	None 表記なし	... Japan 日本国	Q	... Indonesia インドネシア			<p>Year Code(example) 年コード(例)</p> <table border="1"> <tr> <td>2010</td><td>0</td> <td>2020</td><td>K</td> <td>2030</td><td>0</td> </tr> <tr> <td>2011</td><td>1</td> <td>2021</td><td>A</td> <td>2031</td><td>1</td> </tr> <tr> <td>:</td><td>:</td> <td>:</td><td>:</td> <td>:</td><td>:</td> </tr> <tr> <td>2018</td><td>8</td> <td>2028</td><td>H</td> <td>2038</td><td>8</td> </tr> <tr> <td>2019</td><td>9</td> <td>2029</td><td>J</td> <td>2039</td><td>9</td> </tr> </table> <ul style="list-style-type: none"> When the tens digit of Christian era is even number, an alphabetic character (1:A, 2:B...9:J, 0:K, I is excluded.) shall be used for the abbreviation of end of Christian era. 西暦年の+の位が偶数年は末尾略称に英字(1:A, 2:: B...9:J, 0:K, Iを除く)を使用する。 When the tens digit of Christian era is odd number, a numeric character (End of Christian era) shall be used for the abbreviation of end of Christian era. 西暦年の+の位が奇数年は末尾略称に数字(西暦末尾)を使用する。 	2010	0	2020	K	2030	0	2011	1	2021	A	2031	1	:	:	:	:	:	:	2018	8	2028	H	2038	8	2019	9	2029	J	2039	9			<p>Monthly Code 月コード</p> <table border="1"> <tr> <td>Jan.</td><td>1</td> <td>Jul.</td><td>7</td> </tr> <tr> <td>Feb.</td><td>2</td> <td>Aug.</td><td>8</td> </tr> <tr> <td>Mar.</td><td>3</td> <td>Sep.</td><td>9</td> </tr> <tr> <td>Apr.</td><td>4</td> <td>Oct.</td><td>O</td> </tr> <tr> <td>May.</td><td>5</td> <td>Nov.</td><td>N</td> </tr> <tr> <td>Jun.</td><td>6</td> <td>Dec.</td><td>D</td> </tr> </table>	Jan.	1	Jul.	7	Feb.	2	Aug.	8	Mar.	3	Sep.	9	Apr.	4	Oct.	O	May.	5	Nov.	N	Jun.	6	Dec.	D	ERZV20R271				 <p>部品表示の一例 example</p>	
	Trade Mark 製造者識別マーク																																																																																							
ZNR	Product Name 品名																																																																																							
V20 U	Type Name, Abbreviation of Part No. タイプ名, 品番略称 ... Nominal Varistor Voltage 公称バリスタ電圧略称																																																																																							
	UL Recognized Component Mark UL 認定マーク																																																																																							
	CSA Monogram CSA モノグラム																																																																																							
	Factory Identification Marking 工場識別コード																																																																																							
	<table border="1"> <tr> <td>None 表記なし</td> <td>... Japan 日本国</td> </tr> <tr> <td>Q</td> <td>... Indonesia インドネシア</td> </tr> </table>	None 表記なし	... Japan 日本国	Q	... Indonesia インドネシア																																																																																			
None 表記なし	... Japan 日本国																																																																																							
Q	... Indonesia インドネシア																																																																																							
		<p>Year Code(example) 年コード(例)</p> <table border="1"> <tr> <td>2010</td><td>0</td> <td>2020</td><td>K</td> <td>2030</td><td>0</td> </tr> <tr> <td>2011</td><td>1</td> <td>2021</td><td>A</td> <td>2031</td><td>1</td> </tr> <tr> <td>:</td><td>:</td> <td>:</td><td>:</td> <td>:</td><td>:</td> </tr> <tr> <td>2018</td><td>8</td> <td>2028</td><td>H</td> <td>2038</td><td>8</td> </tr> <tr> <td>2019</td><td>9</td> <td>2029</td><td>J</td> <td>2039</td><td>9</td> </tr> </table> <ul style="list-style-type: none"> When the tens digit of Christian era is even number, an alphabetic character (1:A, 2:B...9:J, 0:K, I is excluded.) shall be used for the abbreviation of end of Christian era. 西暦年の+の位が偶数年は末尾略称に英字(1:A, 2:: B...9:J, 0:K, Iを除く)を使用する。 When the tens digit of Christian era is odd number, a numeric character (End of Christian era) shall be used for the abbreviation of end of Christian era. 西暦年の+の位が奇数年は末尾略称に数字(西暦末尾)を使用する。 	2010	0	2020	K	2030	0	2011	1	2021	A	2031	1	:	:	:	:	:	:	2018	8	2028	H	2038	8	2019	9	2029	J	2039	9																																																								
2010	0	2020	K	2030	0																																																																																			
2011	1	2021	A	2031	1																																																																																			
:	:	:	:	:	:																																																																																			
2018	8	2028	H	2038	8																																																																																			
2019	9	2029	J	2039	9																																																																																			
		<p>Monthly Code 月コード</p> <table border="1"> <tr> <td>Jan.</td><td>1</td> <td>Jul.</td><td>7</td> </tr> <tr> <td>Feb.</td><td>2</td> <td>Aug.</td><td>8</td> </tr> <tr> <td>Mar.</td><td>3</td> <td>Sep.</td><td>9</td> </tr> <tr> <td>Apr.</td><td>4</td> <td>Oct.</td><td>O</td> </tr> <tr> <td>May.</td><td>5</td> <td>Nov.</td><td>N</td> </tr> <tr> <td>Jun.</td><td>6</td> <td>Dec.</td><td>D</td> </tr> </table>	Jan.	1	Jul.	7	Feb.	2	Aug.	8	Mar.	3	Sep.	9	Apr.	4	Oct.	O	May.	5	Nov.	N	Jun.	6	Dec.	D																																																														
Jan.	1	Jul.	7																																																																																					
Feb.	2	Aug.	8																																																																																					
Mar.	3	Sep.	9																																																																																					
Apr.	4	Oct.	O																																																																																					
May.	5	Nov.	N																																																																																					
Jun.	6	Dec.	D																																																																																					
ERZV20R271																																																																																								
	 <p>部品表示の一例 example</p>																																																																																							

Note/Revision

CLASSIFICATION	PRODUCT REFERENCE DATA SHEET	
SUBJECT	ZNR SURGE ABSORBER V-SERIES (Bulk Type) ERZV20R271	17 - 20

7. Packing

7.1 Packing quantity shall be shown Table 4

7.2 ZNR Surge Absorbers shall be packed in plastic bag, and then packed into carton box.

7.3 Dimensions of packing materials and marking on the packing materials shall be shown Fig. 2.1 and Fig. 2.2

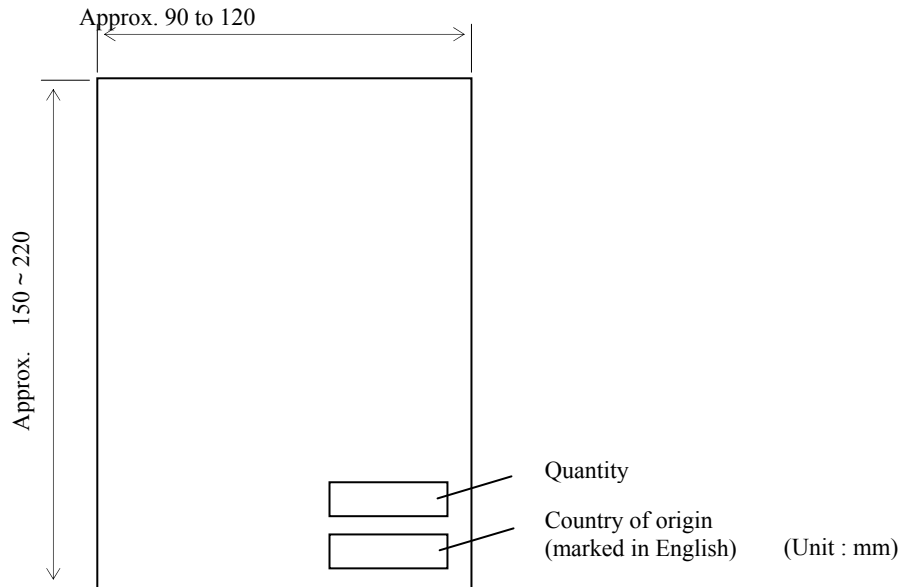

Fig 2.1 Bag

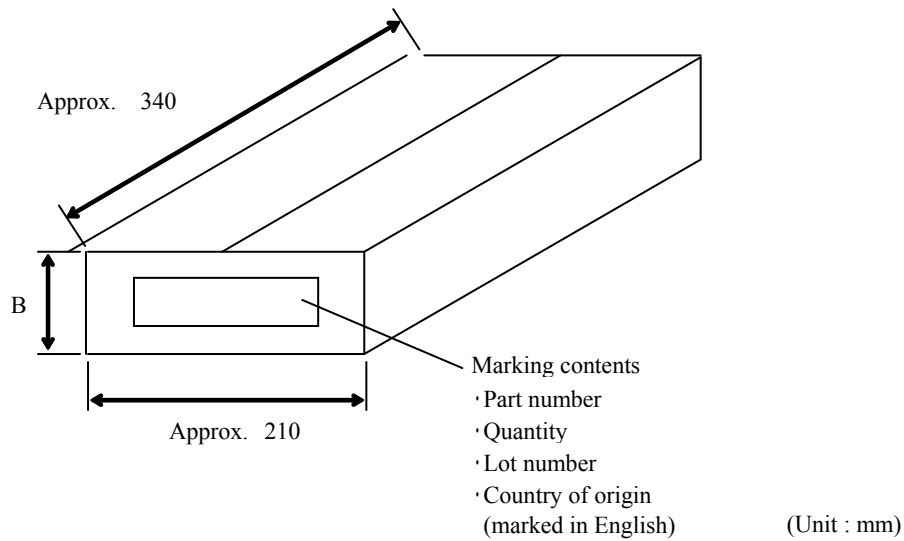

Fig 2.2 Carton box

Note/Revision

CLASSIFICATION	PRODUCT REFERENCE DATA SHEET	
SUBJECT	ZNR SURGE ABSORBER V-SERIES (Bulk Type) ERZV20R271	
		18 - 20

Table 4 Series V20

Part Numbers	Quantity in Packing Unit pcs.	Packing Quantity in Carton pcs.	Dimension B (mm)
ERZV20R271	50	2,000	Approx. 160

Note/Revision

CLASSIFICATION	PRODUCT REFERENCE DATA SHEET	
SUBJECT	ZNR SURGE ABSORBER V-SERIES (Bulk Type) ERZV20R271	
		19 - 20

7.4 Packing Indication Contents of Label

7.4.1 Bar Code Label Specification

Bar code symbology : EIAJ Code39
 Label size : 90.0 mm x 45.0 mm
 Bar code height : 5 mm
 Bar code dimension
 Wide element width : 0.334 mm
 Narrow/Wide bar ratio : 1:2
 Inter character gap : 0.167 mm
 Quiet zone : 3.81 mm
 Bar code resolution : 11.70 character/inch

7.4.2 Bar Code Contents

Bar Code 1	*	3N	1	Panasonic P/N	SP	Quantity	*
------------	---	----	---	---------------	----	----------	---

Bar Code 2	*	3N	2	SP	Serial No.	SP	Vender code	*
------------	---	----	---	----	------------	----	-------------	---

Bar Code 3	*	1P	Panasonic P/N	*
------------	---	----	---------------	---

7.4.3 Label Contents

Panasonic P/N, Quantity, Lot.No., Country of origin, Company name, etc.

7.4.4 Constitution of Lot No.

2 4 02 GH A67
 | | | day Fix Consecutive No(ex. A01,A02,...,A99,B01,...)
 | Month(1,2,...,9,O,N,D)月
 Year(Last digit)

7.4.5 Label Form and Examples (ERZV07D471)



Note/Revision

CLASSIFICATION	PRODUCT REFERENCE DATA SHEET	
SUBJECT	ZNR SURGE ABSORBER V-SERIES (Bulk Type) ERZV20R271	
		20 - 20

8. Country of origin

8.1 Country of origin	Japan	Indonesia
8.2 Factory name	Panasonic Corporation	P.T. Panasonic Industrial Devices Batam
8.3 Address	1037-2 Kamiosatsu, Chitose City, Hokkaido 066-8502 Japan	Puri Industrial Park 2000, Batam Centre, Kelurahan Baloi Permai Batam
8.4 Factory Identification Method	Factory Identification Marking : None	Factory Identification Marking : Q

Note/Revision

单击下面可查看定价，库存，交付和生命周期等信息

[>>Panasonic\(松下\)](#)