

FJ4B01100L1

Single P-channel MOS FET

For Load switching circuits

■ Features

- Low Drain-source ON resistance: $R_{ds(on)}$ typ. = 68 m Ω ($V_{GS} = -2.5$ V)
- CSP (Chip Size Package)
- RoHS compliant (EU RoHS / MSL: Level 1 compliant)

■ Marking Symbol: 1D

■ Packaging

Embossed type (Thermo-compression sealing) : 1 000 pcs / reel (standard)

■ Absolute Maximum Ratings $T_a = 25$ °C

Parameter	Symbol	Rating	Unit
Drain-Source Voltage	VDS	-12	V
Gate-Source Voltage	VGS	± 8	V
Drain Current	ID1 ^{*1}	-2.2	A
	ID2 ^{*2}	-3.3	
	ID3 ^{*3}	-4.1	
Peak Drain Current	IDp1 ^{*1*4}	-17	A
	IDp2 ^{*2*4}	-26	
	IDp3 ^{*3*4}	-32	
Power Dissipation	PD1 ^{*1}	0.36	W
	PD2 ^{*2}	0.82	
	PD3 ^{*3}	1.3	
Channel Temperature	Tch	150	°C
Operating Ambient Temperature	Topr	-40 ~ +85	°C
Storage Temperature	Tstg	-55 ~ +150	°C

Note *1 FR4 board (25.4mm×25.4mm×1.0mm), Min Cu 36mm² Copper

*2 FR4 board (25.4mm×25.4mm×1.0mm), Full Cu

*3 Ceramic substrate (70mm×70mm×1.0mm)

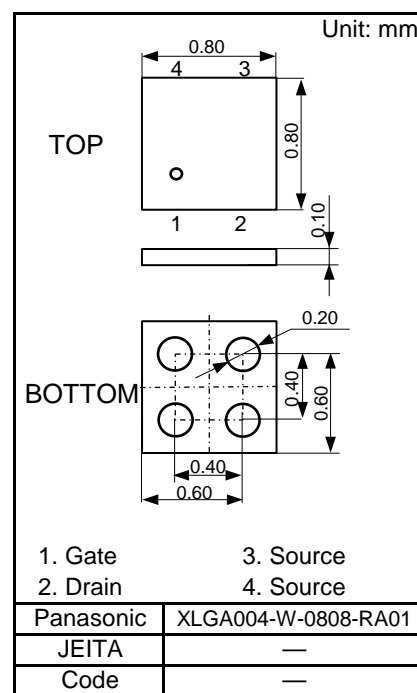
*4 $t = 10$ μ s, Duty Cycle < 1%

■ Internal Connection

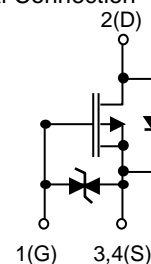

■ Electrical Characteristics Ta = 25 °C ± 3 °C

Parameter	Symbol	Conditions	Min	Typ	Max	Unit
Drain-Source Breakdown Voltage	VDSS	ID = -1 mA, VGS = 0	-12			V
Zero Gate Voltage Drain Current	IDSS	VDS = -12 V, VGS = 0			-10	μA
Gate-Source Leakage Current	IGSS	VGS = ±8 V, VDS = 0 V			±10	μA
Gate Threshold Voltage	Vth	ID = -1.2 mA, VDS = -10 V	-0.3		-1.0	V
Drain-Source ON Resistance	RDS(on)	ID = -1.5 A, VGS = -4.5 V		57	74	mΩ
		ID = -1.5 A, VGS = -2.5 V		68	90	
		ID = -0.2 A, VGS = -1.8 V		82	139	
		ID = -0.1 A, VGS = -1.5 V		97	290	
Input Capacitance ^{*1}	Ciss	VDS = -10 V		459		pF
Output Capacitance ^{*1}	Coss	VGS = 0		85		
Reverse Transfer Capacitance ^{*1}	Crss	f = 1MHz		75		
Turn-on delay time ^{*1,*2}	td(on)	VDD = -6 V VGS = 0 to -4.5 V ID = -1.0 A		8		ns
Rise time ^{*1,*2}	tr			11		
Turn-off delay time ^{*1,*2}	td(off)			59		
Fall time ^{*1,*2}	tf			10		
Total Gate Charge ^{*1}	Qg	VDD = -6 V		7		nC
Gate to Source Charge ^{*1}	Qgs	VGS = -4.5 V		0.75		nC
Gate to Drain Miller Charge ^{*1}	Qgd	ID = -1.0 A		0.95		nC
Body Diode Forward Voltage	VF(D-S)	IF = -0.2A, VGS = 0V		-0.7	-1.2	V

Note Measuring methods are based on JAPANESE INDUSTRIAL STANDARD JIS C 7030 Measuring methods for transistors.

*1 Guaranteed by design, not subject to production testing

*2 Measurement circuit for Turn-on delay time / Rise time / Turn-off delay time / Fall time

■ Electrical State Discharge Characteristics

Standard	Test Type	Symbol	Conditions	Class	Value	Unit
AEC-Q101-001	Human body model	HBM	C = 100 pF, R = 1.5 kΩ	H1C	>1k to ≤ 2k	V
	Machine model	MM	C = 200 pF, R = 0 Ω	M2	>100 to ≤ 200	V



Note2: Measurement circuit

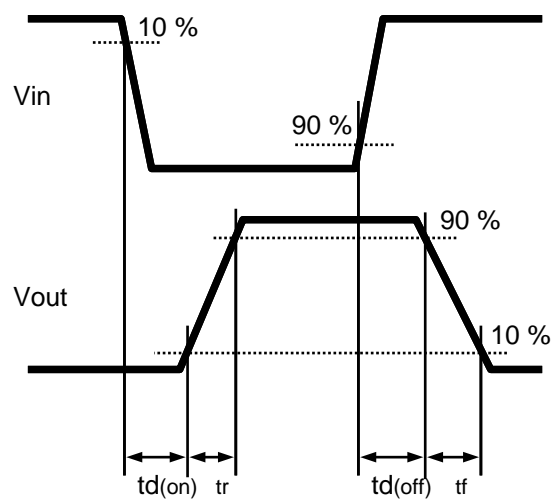
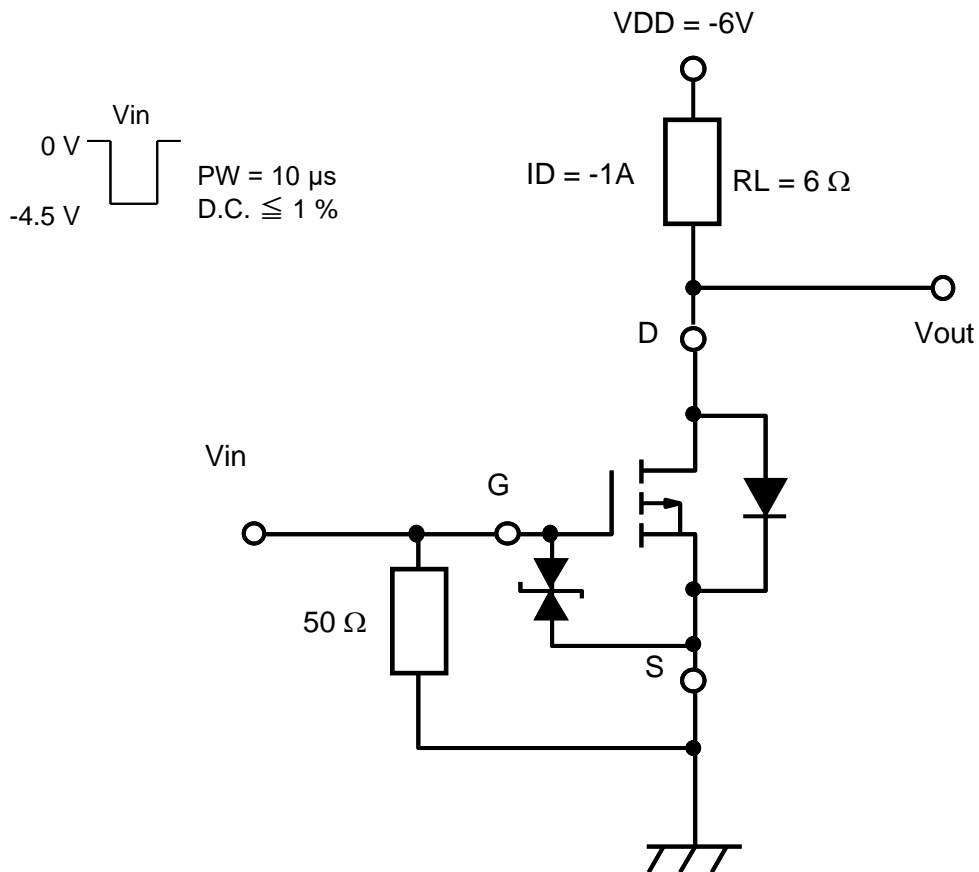

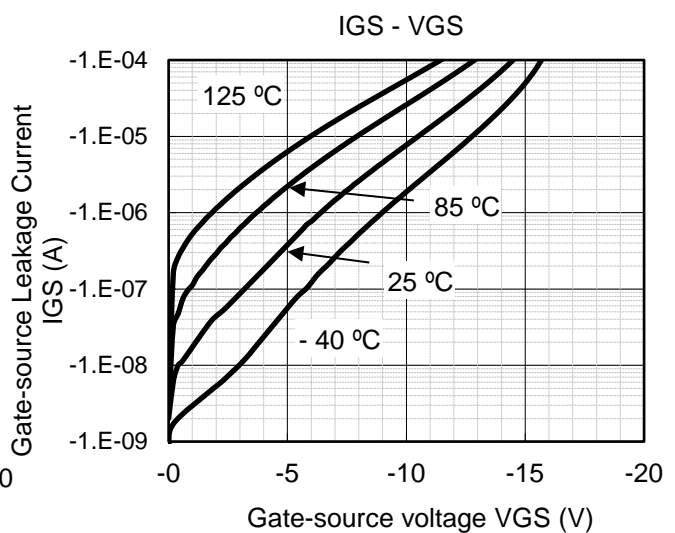
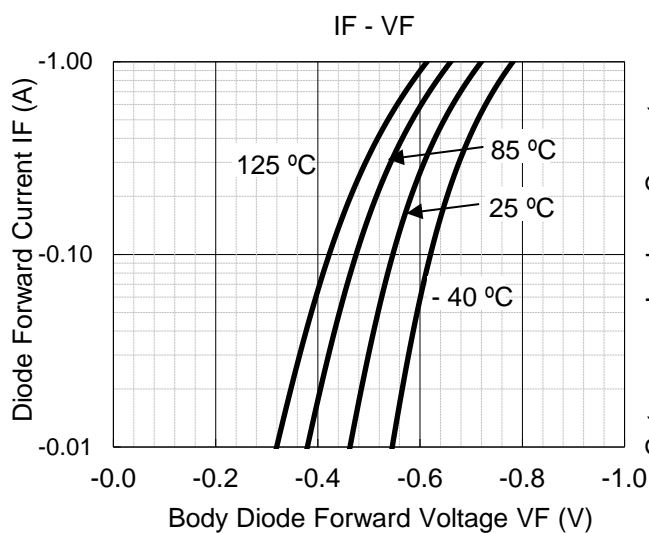
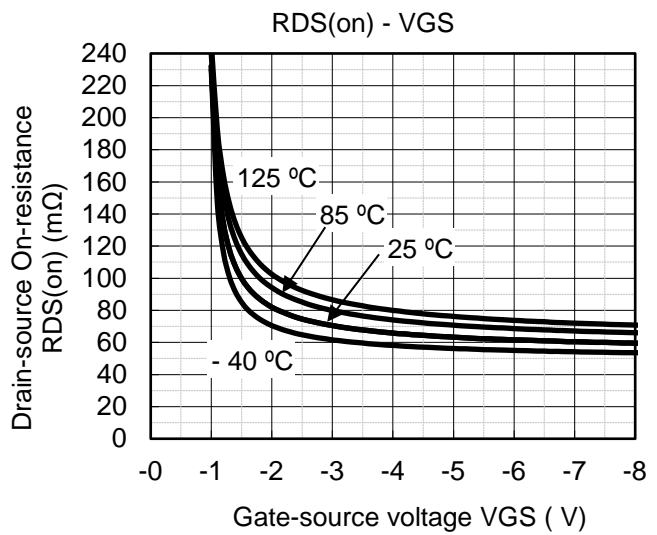
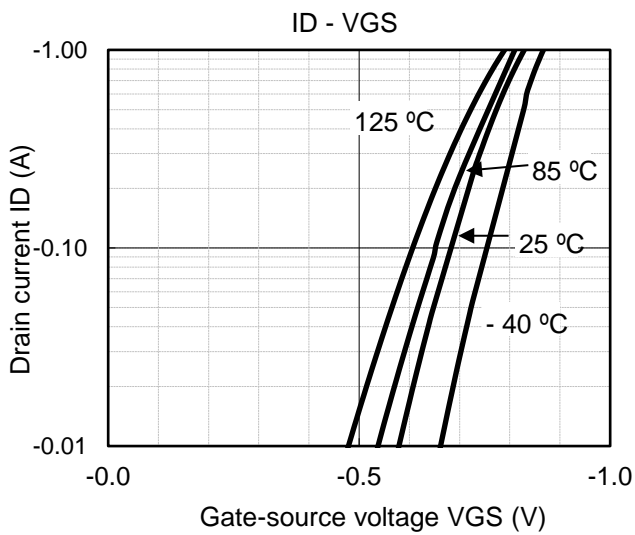
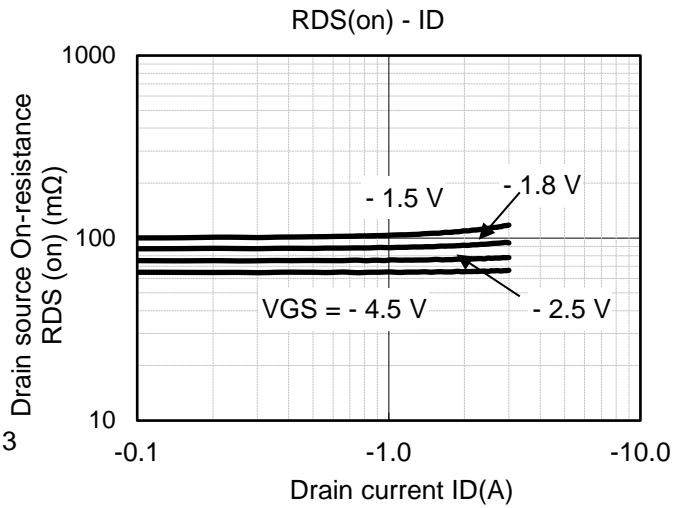
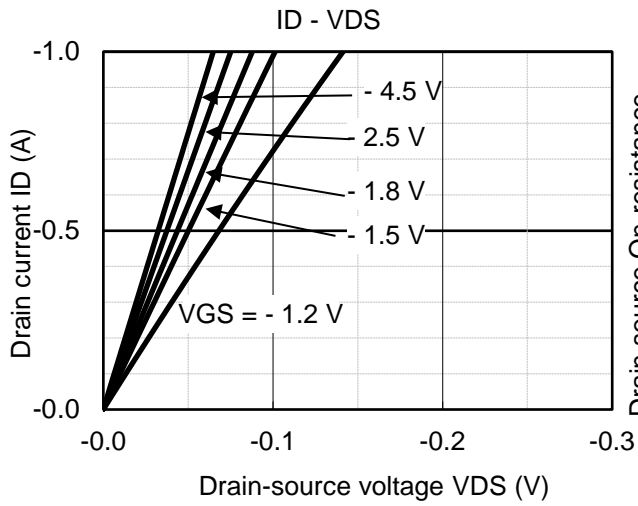



IDS - VDS

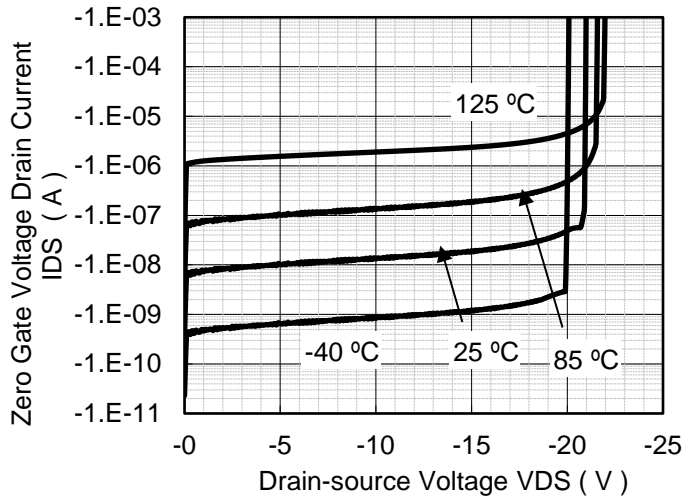

Dynamic Input/Output Characteristics

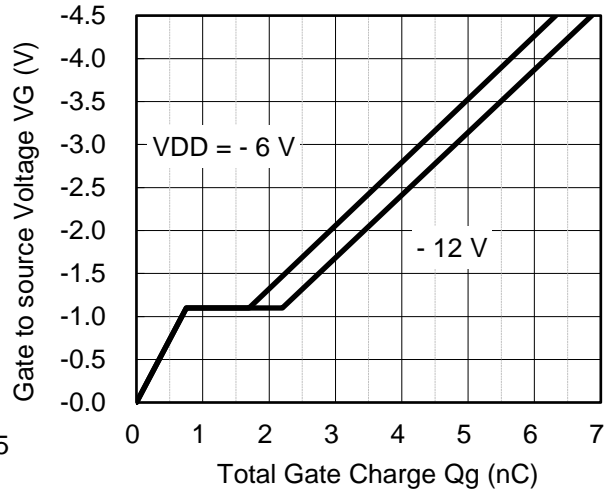

Rth - tsw

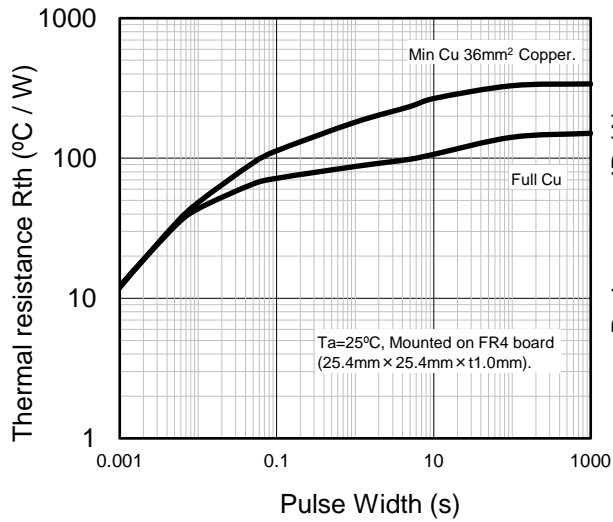

Safe Operating Area

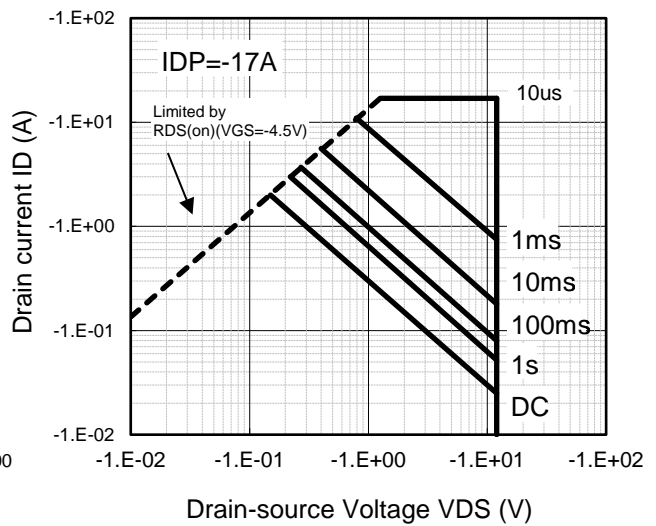

■ XLGA004-W-0808-RA01

Unit: mm

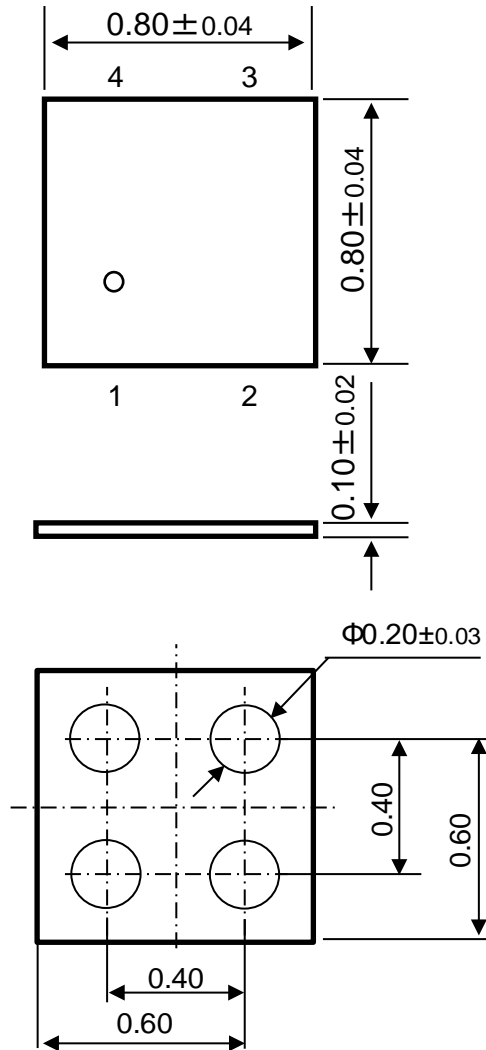

■ Land Pattern (Reference)

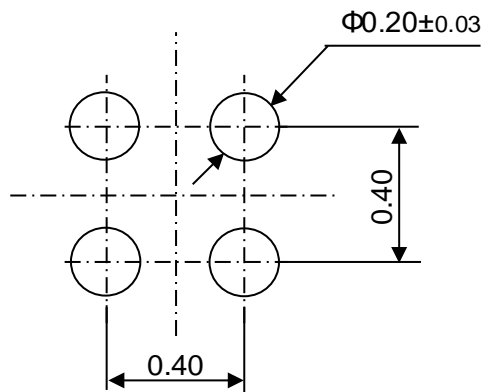

单击下面可查看定价，库存，交付和生命周期等信息

[>>Panasonic\(松下\)](#)