



Panel mounting type
One-touch installation type



Panel mounting type
Installation frame type



PC board mounting type

Features

1. 8.7 mm .343 inch Character Height (previously 7 mm)
Easy-to-read character height increased from 7 mm to 8.7 mm .276 inch to .343 inch.



2. Plenty of Digits



3. Counting Speed Switchable between 2 KHz and 30 Hz

4. Panel Mounting Type Features 2 Installation Methods

Comes with very easy one-touch installation type and also installation frame type that uses the bracket on the timer/counter. Choose a method that suits the application.

5. Battery Replacement Easy on Environment

To replace battery simply remove body for the one-touch installation type, and remove battery lid for the installation frame type.

6. Screw Terminals Designed for Safety
Built in finger protection.

7. Panel Covers Replaceable (Standard color is ash gray.)

Change the panel design by replacing with a black panel cover.

8. Conforms to IP66 Protective Construction (Only Installation frame type.) (Front panel surface)

9. Input Methods

- 1) Non-voltage input method
- 2) Voltage input method
- 3) Free voltage input method

10. Backlight Type Added to Series and Now 2-color Switchable (green/red)

Easy viewing even in dark places and switchable between green and red (Voltage input type).

11. Conforms to Safety Regulations

PRODUCT CHART

Installation type	Type	Standard type			Backlight type
		Non-voltage input type	Voltage input type (4.5 to 30 V DC)	Free voltage input type (24 to 240 V AC/DC)	
Panel mounting type	One-touch installation type	○	○	○	○
	Installation frame type	○	○	○	○
PC board mounting type		○	—	—	—

PRODUCT TYPES

1. Panel mounting type

- 1) One-touch installation type
- ① Standard type

No. digits	Counting speed	Front reset	Input method		Part No.
			Non-voltage input type	Voltage input type (4.5 to 30 V DC)	
8 digits	2 KHz/30 Hz switchable 30 Hz	Yes	Non-voltage input type (4.5 to 30 V DC)	Voltage input type (24 to 240 V AC/DC)	LC2H-FE-2KK LC2H-FE-DL-2KK LC2H-FE-FV-30

Note) Please ask us about types without front resetting.

② Backlight type

No. digits	Counting speed	Front reset	Input method	Part No.
8 digits	2 KHz/30 Hz switchable	Yes	Voltage input type (4.5 to 30 V DC)	LC2H-FE-DL-2KK-B

2) Installation frame type

① Standard type

No. digits	Counting speed	Front reset	Input method		Part No.
			Non-voltage input type	Voltage input type (4.5 to 30 V DC)	
8 digits	2 kHz/30 Hz switchable	Yes	Non-voltage input type	Voltage input type (4.5 to 30 V DC)	LC2H-F-2KK
			Free voltage input type (24 to 240 V AC/DC)		LC2H-F-DL-2KK
	30 Hz				LC2H-F-FV-30

Note) Please ask us about types without front resetting.

② Backlight type

No. digits	Counting speed	Front reset	Input method	Part No.
8 digits	2 kHz/30 Hz switchable	Yes	Voltage input type (4.5 to 30 V DC)	LC2H-F-DL-2KK-B

2. PC board mounting type

No. digits	Counting speed	Front reset	Input method		Part No.
			Non-voltage input type	Voltage input type	
8 digits	2 kHz 30 Hz	No	Non-voltage input type		LC2H-C-2K-N
					LC2H-C-30-N

SPECIFICATIONS

1. Panel mounting type

Item	Type	Standard type		Backlight type		Standard type
		Non-voltage input	Voltage input	Backlight type	Free voltage type	
No. digits		8 digits				
External power supply		Not required (Built-in battery)				
Max. counting speed		2 kHz/30 Hz (Switchable by switch)		30 Hz (Note 2)		
Min. input signal width (ON: OFF = 1:1)	Input method (signal)	0.25 ms/16.7 ms (Switchable by switch)		16.7 ms		
		Non-voltage input using contacts or open collector connection	High level: 4.5 to 30 V DC Low level: 0 to 2 V DC	High level: 24 to 240 V AC/DC Low level: 0 to 2.4 V AC/DC		
Count Input	Input impedance	When shorted: Max. 10 kΩ When open: Max. 750 kΩ		Approx. 4.7 kΩ		
		Residual voltage	Max. 0.5 V	—		
Reset Input	Input method (signal)	Non-voltage input using contacts or open collector connection		High level: 4.5 to 30 V DC Low level: 0 to 2 V DC		
		Input impedance	When shorted: Max. 10 kΩ When open: Max. 750 kΩ	Approx. 4.7 kΩ		
Display method	Residual voltage	Max 0.5 V		—		
		7-segment LCD		7-segment LCD With green/red backlight		7-segment LCD
Breakdown voltage (initial)		Between charged and uncharged parts: 1,000 V AC for 1 minute.		Between charged and uncharged parts: 2,000 V AC for 1 minute.		
Insulation resistance (initial)		Min. 100 MΩ (measured at 500 V DC) Measurement location same as for break down voltage.		—		
Backlight power		—		24 V DC (±10%)		
Protective construction (Note 3)		IEC Standard IP66 (only panel front: when using rubber gasket)				
Accessories (Note 3)		Rubber gasket, mounting bracket				
Battery life		7 years (at 25°C 77°F) Note 1			6 years (at 25°C 77°F)	

Notes) 1. The value given for battery life is calculated based on continuous operation (count input signal ON/OFF = 1:1), therefore, this value is not guaranteed.

Also, battery life is decreased 30% when operation is continuous with 2 kHz count inputting in 2 kHz mode.

2. Operation is at 25 Hz when using 24 V AC.

3. Only for installation frame type.

LC2H

2. PC board mounting type

Item	Type	PC board mounting type
Input method		Non DC voltage input
No. digits		8 digits
Rated operation voltage		3 V DC
Allowable operation voltage range		2.7 to 3.3 V DC
Current consumption		Max. 30 µA (max. 250 µA during reset input)
Max. counting speed		2 KHz
Min. input signal width (ON: OFF = 1:1)		0.25 ms
Count input		Non-voltage input using contacts or open collector connection
Residual voltage		When shorted: Max. 10 kΩ When open: Max. 750 kΩ
Min. input signal width		Max. 0.5 V
Input method		10 ms
Input impedance		Non-voltage input using contacts or open collector connection
Reset input		When shorted: Max. 10 kΩ When open: Max. 750 kΩ
Residual power		Max. 0.5 V
Break down voltage (initial)		Between charged and uncharged parts: 1,000 V AC for 1 minute.
Insulation resistance (initial)		Min. 100 MΩ (measured at 500 V DC) Measurement location same as for break down voltage.

3. Common

Item	Type	Panel mounting/PC board mounting types
Vibration resistance	Functional	10 to 55 Hz (1 cycle/min.), single amplitude: 0.15 mm, .006 inch (10 min. on 3 axes)
	Destructive	10 to 55 Hz (1 cycle/min.), single amplitude: 0.375 mm, .015 inch (1 hr. on 3 axes)
Shock resistance	Functional	Min. 98 m/s ² (4 times on 3 axes)
	Destructive	Min. 294 m/s ² (5 times on 3 axes)
Operation temperature		-10 to +55°C +14 to +131°F (without frost or dew)
Storage temperature		-25 to +65°C -13 to +149°F (without frost or dew)
Ambient humidity		35 to 85% RH

PART NAMES

1. Front reset button

This button resets the count value. It does not work when the lock switch is ON. Be aware that battery life will decrease if this switch is used frequently.

2. Lock switch (Refer to chart on right.)

Disable the front reset button.

Note) Turn ON at the LCD side (reset disabled) and OFF at the terminal block side (reset enabled).

3. Count speed switch (Refer to chart on right.)

Use this switch to switch the count speed between 30 Hz and 2 KHz. (On the non-voltage and voltage input types, 30 Hz is on the LCD side and 2 KHz is on the terminal block side. Fixed at 30 Hz for free voltage input type.)

Note) You must press the front reset button when you change the count speed setting.

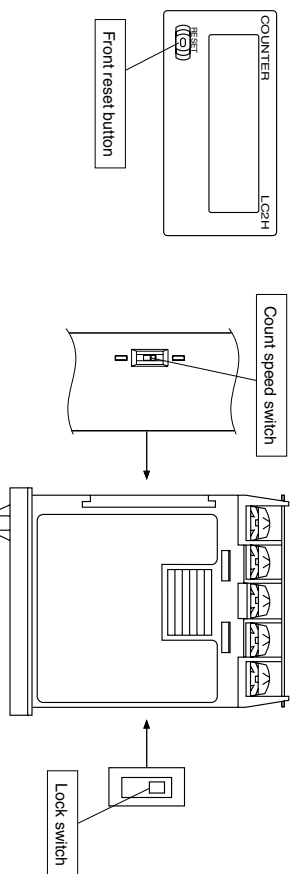

	Non-voltage input/voltage input	Free voltage input
Lock switch (Unit display 1)	(Terminal block side) (LCD side) OFF* ON	—
Count speed switch (Unit display 2)	(Terminal block side) 2K Hz (LCD side) 30Hz*	— (Fixed at 30 Hz)

Notes) 1. *Default setting when shipped.

2. Make the switch setting before installing to panel.

Dimensions

mm inch
General tolerance: ±1.0 ±.039

1. Panel mounting type

• External dimensions

1) One-touch installation type

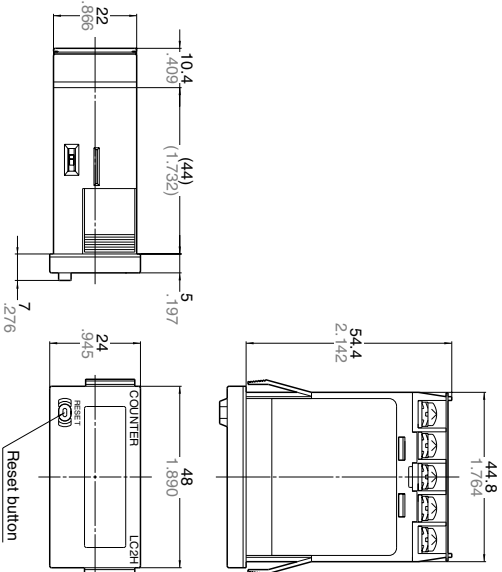

2) Installation frame type

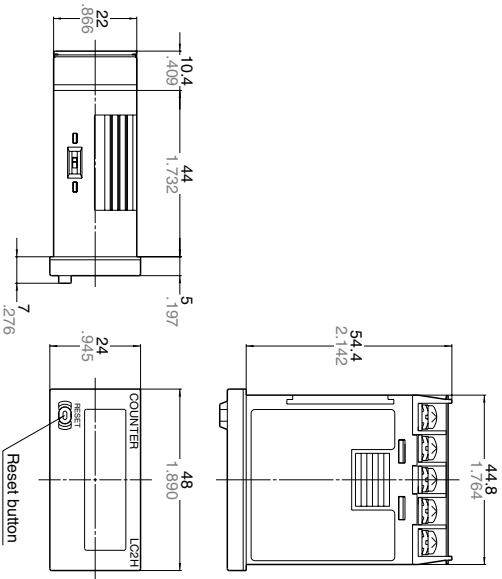

• Panel installation diagram

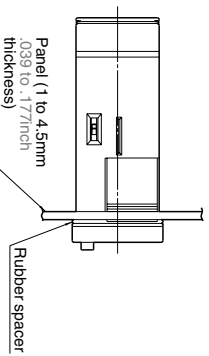

Note) When installing to a 4.5 mm .177 inch thick panel, remove the rubber spacer first.

• Panel installation diagram

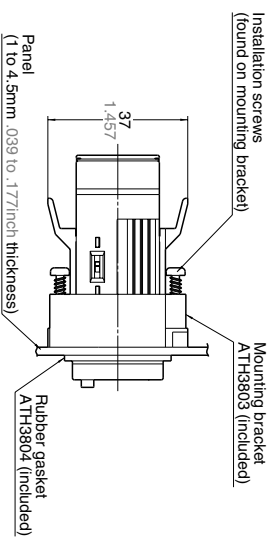

• Panel cut-out dimensions

The standard panel cut-out is shown below.
Use the mounting bracket (ATH3803) and the rubber packing (ATH3804).
(Only mounting bracket installation type.)

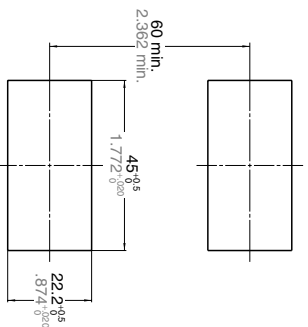

• When installing repeatedly (sealed installation)
(Only mounting bracket installation type.)

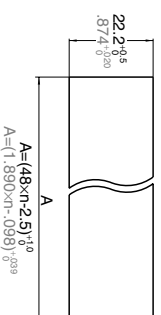

Notes) 1. Suitable installation panel thickness is 1 to 4.5 mm .039 to .177 inch.
2. Waterproofing will be lost when installing repeatedly (sealed installation).

• Terminal layout and wiring diagrams

1) Standard type

Non voltage input type	Voltage input type	Free voltage input type

2. Backlight type

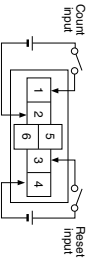
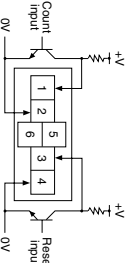
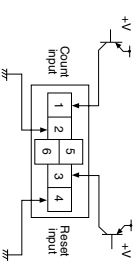
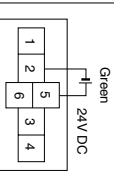
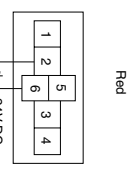
		Voltage input type		Backlight connection	
Contact input	Transistor input type	NPN transistor	PNP transistor	Backlight connection	
					

Notes) 1. Do not reverse the polarities when connecting the DC voltage for the backlight.
 2. ② and ④. (The input and reset circuits are functionally insulated.)
 3. When using transistor (Tr) input, use the right as a guide. (Collector with stand voltage \cong 50 V, leakage current < 1 μ A)
 4. Be aware that the application of voltage that exceeds the voltage range of the H level to the count input terminal, and the application of voltage to the reset input terminal, can cause damage to the internal elements.

Explanation of operation

- Counting takes place when the count input signal is ON.
- Counting resumes again when the count value reaches 99999999 (full scale value) and then returns to "0" with a new count input.
- No measurement takes place when a reset is input.
 - When reset is ON, resetting takes place and the count becomes "0".
 - Press the front reset button when you want to reset manually (only panel installation type).

(Note) Be aware that battery life will decrease if the count input or reset input are left ON.

Cautions for use

**1. Non-voltage input type
For both panel mounting and PC board mounting types**

- Never apply voltage to the non-voltage input type. This will damage the internal elements. Also, since there is a possibility of erroneous operation, do not connect in parallel the inputs of a non-voltage input type and another counter from a single input signal.
- Since the current flow is very small from the count input and reset input terminals (① and ③ on the panel mounting type and terminals ⑫ to ⑰ and ⑳ to ㉑ on the PC board mounting type) please use relays and switches with high contact reliability.
- When inputting with an open collector of a transistor, use a transistor for small signals in which ICBO is 1 μ A or less and always input with no voltage.
- When wiring, try to keep all the input lines to the count and reset inputs as short as possible and avoid running them together with high voltage and power transmission lines or in a power conduit. Also, malfunctions might occur if the floating capacitance of these wires exceeds 500 pF (10 m 32.808 ft. for parallel wires of 2

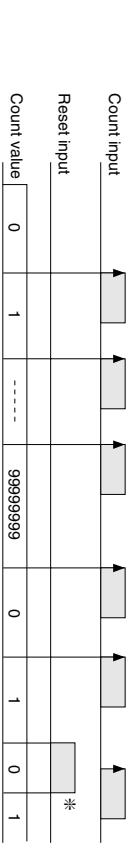

Note) *Count becomes "1" when the reset input is turned OFF while the count signal is being input.

mm²). When using 2 KHz mode, use with a wiring floating capacitance of 120 pF (3 m 9.843 ft. for parallel wires of 2 mm²). In particular, when using shielded wiring, be careful of the capacitance between wires.

PC board mounting type

- For external power supply use manganese dioxide or lithium batteries (CR type: 3V).
 - Always reset after external power is applied and confirm that the display reads "0".
 - Make the wiring from the battery to the counter unit as short as absolutely possible. Also, be careful of polarity.
 - Calculate battery life with the following formula.

$$t = A/I$$
 t: battery life [h]
 I: LC2H current consumption [mA]
 A: battery capacity until minimum operation voltage is reached [mAh]
 - Hand solder to the lead terminal. Do not dip solder. With the tip of the soldering iron at 300°C 572°F perform soldering within 3 seconds (for 30 to 60 W soldering iron).
- Voltage input type**
 - Be aware that applying more than 30 V

DC to count input terminals ① and ②, and reset input terminals ③ and ④ will cause damage to the internal elements.

- For external resetting use H level (application of 4.5 to 30 V DC) between reset terminals ③ and ④ of the rear terminals. In this case, connect + to terminal ③ and - to terminal ④. This is the valid polarity; therefore, the counter will not work if reversed.
- When wiring, try to keep all the input lines to the count and reset inputs as short as possible and avoid running them together with high voltage and power transmission lines or in a power conduit. Also, malfunctions might occur if the floating capacitance of these wires exceeds 500 pF (10 m 32.808 ft. for parallel wires of 2 mm²).
- Free voltage input type**
 - Use count input terminals ① and ② for free voltage input and reset terminals ③ and ④ for non-voltage input.
 - Be aware that the application of voltage that exceeds the voltage range of the H level to the count input terminal, and the application of voltage to the reset input terminal, can cause damage to the internal elements.

- 3) Since the current flow is very small from reset input terminal ③, please use relays and switches with high contact reliability.
- 4) When inputting a reset with an open collector of a transistor, use a transistor for small signals in which ICBO is 1 μA or less and always input with no voltage.
- 5) To reset externally, short reset input terminals ③ and ④ on the rear.
- 6) Input uses a high impedance circuit; therefore, erroneous operation may occur if the influence of induction voltage is present. If you plan to use wiring for the input signal that is 10 m or longer (wire capacitance 120 pF/m at normal temperature), we recommend the use of a CR filter or the connection of a bleeder resistor.

4. How to reset multiple panel mounting type counters all at once (input is the same for count)
Non-voltage input type

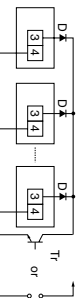

Notes) 1. Use the following as a guide for choosing transistors used for input (Tr).

- Leakage current < 1 μA
- 2. Use as small a diode (D) as possible in the forward voltage so that the voltage between terminals 3 and 4 during reset input meets the standard value (0.5 V).
- (At IF = 20 μA, forward voltage 0.1 and higher.)

Voltage input type

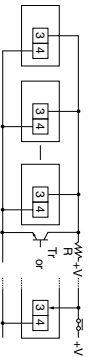

Note) Make sure that H (reset ON) level is at least 4.5 V.

5. Backlight luminance

To prevent varying luminance among backlights when using multiple Backlight types, please use the same backlight power supply.

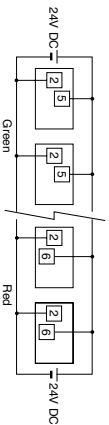

6. Insulation sheet

Before using a panel mounting type, please pull and remove the insulation sheet from the side of the product in the direction of the arrow.

In consideration that the product might be stored for long periods without being used, an insulation sheet is inserted before shipping. Remove the insulation sheet and press the front reset button.

单击下面可查看定价，库存，交付和生命周期等信息

[>>Panasonic\(松下\)](#)