

## Round Type φ5.0mm Series

Type No.      Lighting Color  
LN21CAL(UQS) ..... Red

### Absolute Maximum Ratings (Ta=25°C)

Lighting Color	P <sub>D</sub> (mW)	I <sub>F</sub> (mA)	I <sub>FP</sub> (mA)*	V <sub>R</sub> (V)	T <sub>opr</sub> (°C)	T <sub>stg</sub> (°C)
Red	70	30	150	3	-25 ~ +85	-30 ~ +100

\* The condition of I<sub>FP</sub> is duty 10%, Pulse width 1 msec

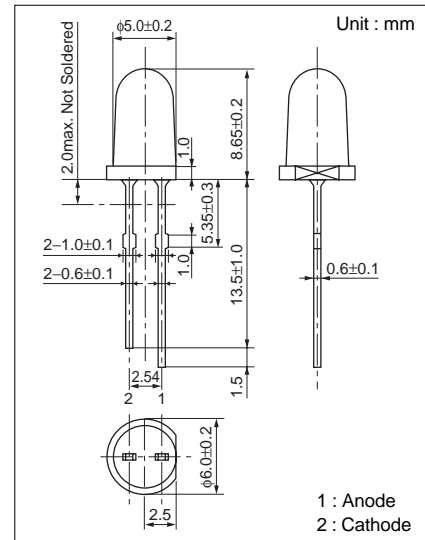

### Electro-Optical Characteristics (Ta=25°C)

Type No.	Lighting Color	Lens Color	I <sub>O</sub>		I <sub>F</sub>	V <sub>F</sub>		λ <sub>P</sub>	Δλ	I <sub>F</sub>	I <sub>R</sub>	
			typ	min		typ	max				max	V <sub>R</sub>
LN21CAL(UQS)	Red	Clear	1500	1000	20	1.8	2.4	660	20	20	100	3
Unit	—	—	mcd	mcd	mA	V	V	nm	nm	mA	μA	V

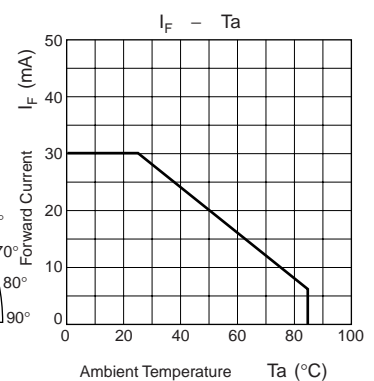
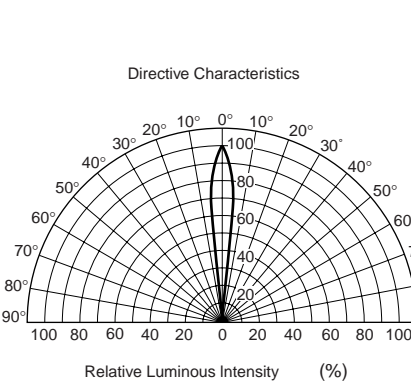
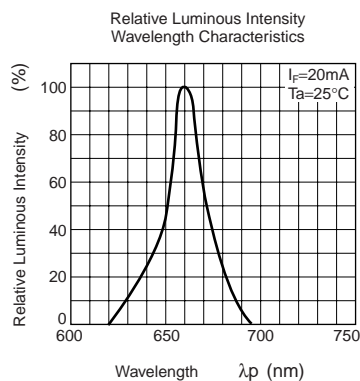
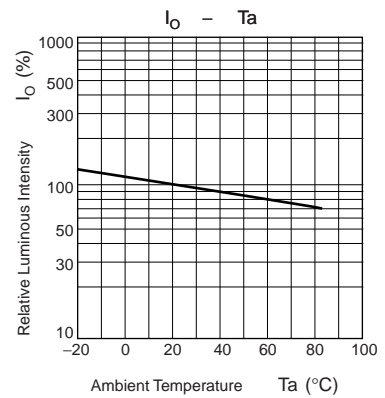
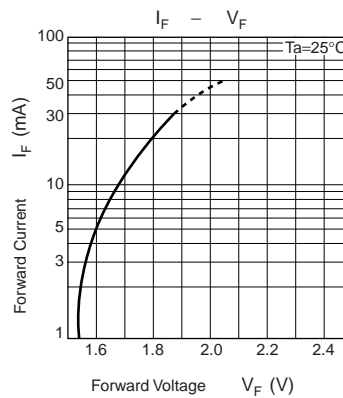
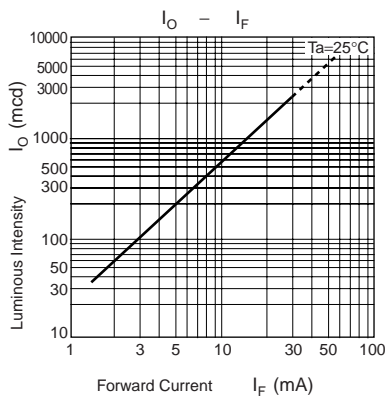

单击下面可查看定价，库存，交付和生命周期等信息

[>>Panasonic\(松下\)](#)