

丸形 Round Type
 ϕ 5.0mm Series

Type No. Lighting Color
 LN21CAL(US).....Red

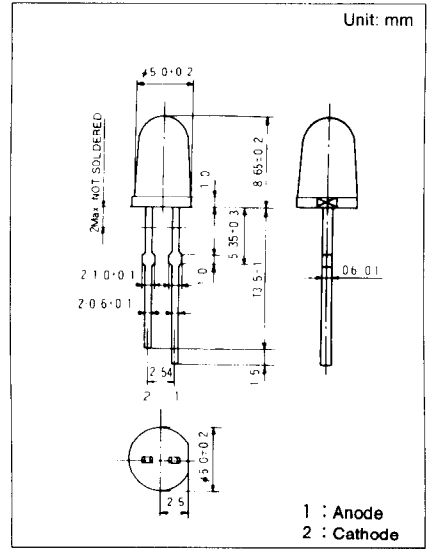

絶対最大定格 Absolute Maximum Ratings (Ta=25 °C)

Lighting Color	P _D (mW)	I _F (mA)	I _{FP} (mA)*	V _R (V)	T _{opr} (°C)	T _{stg} (°C)
Red	70	30	150	3	-25--+85	-30--+100

* I_{FP}の条件は、duty 10%、Pulse width 1 msec. The condition of I_{FP} is duty 10%, Pulse width 1 msec

電気的光学的特性 Electro-Optical Characteristics (Ta=25 °C)

Type No.	Lighting Color	Lens Color	I _o			V _F		λ_p	$\Delta \lambda$	I _F	I _R	
			Typ.	Min.	I _F	Typ.	Max.				I _F	Max.
LN21CAL(US)	Red	Clear	500	300	20	1.8	2.6	665	20	20	100	3
Unit			mcd	mcd	mA	V	V	nm	nm	mA	μ A	V

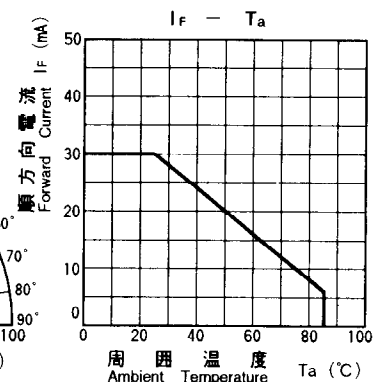
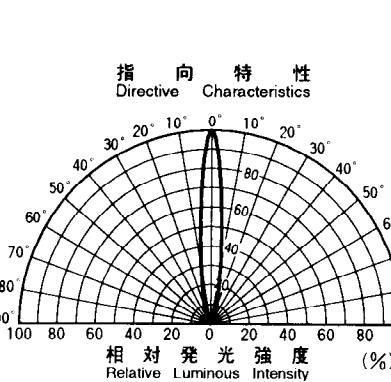
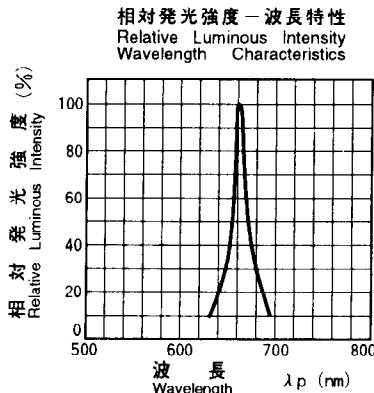
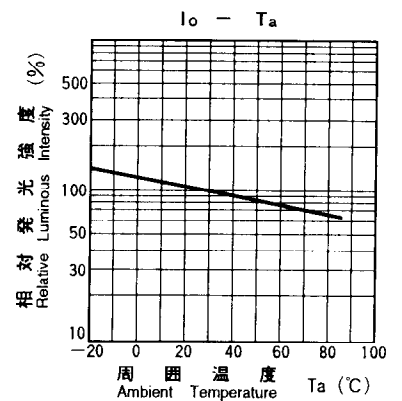
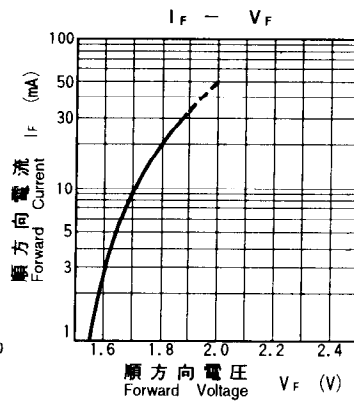
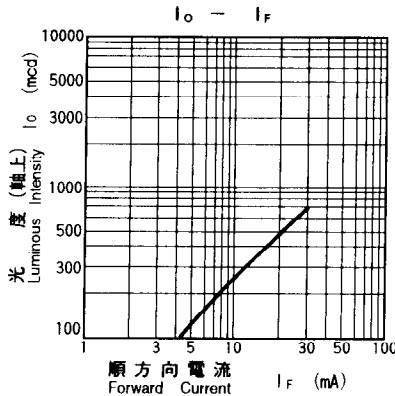

单击下面可查看定价，库存，交付和生命周期等信息

[>>Panasonic\(松下\)](#)