

Notification about the transfer of the semiconductor business

The semiconductor business of Panasonic Corporation was transferred on September 1, 2020 to Nuvoton Technology Corporation (hereinafter referred to as "Nuvoton"). Accordingly, Panasonic Semiconductor Solutions Co., Ltd. became under the umbrella of the Nuvoton Group, with the new name of Nuvoton Technology Corporation Japan (hereinafter referred to as "NTCJ").

In accordance with this transfer, semiconductor products will be handled as NTCJ-made products after September 1, 2020. However, such products will be continuously sold through Panasonic Corporation.

Publisher of this Document is NTCJ.

If you would find description "Panasonic" or "Panasonic semiconductor solutions", please replace it with NTCJ.

※ Except below description page

"Request for your special attention and precautions in using the technical information and semiconductors described in this book"

Nuvoton Technology Corporation Japan

Description

LNC728MS01WW is a MOCVD fabricated 780nm band wavelength laser diode with multi quantum well structure, using TO-56 CAN package to ensure versatile use.

Features

- Wavelength: 783 nm (typ.)
- High output power and temperature: 200 mW , Max+85°C (CW)
380 mW , Max+85°C (pulse)
- Package: TO-56 CAN
- With photo diode(PD)

Applications

- Optical disk drive
- Sensing
- Analysis
- Measurement
- Agriculture
- Other industrial use

Package



Absolute Maximum Ratings

Item	Symbol	Value	Unit	Condition
Output power	Po	200	mW	CW
		380	mW	pulse ¹⁾
Reverse voltage	LD	Vr_LD	1.5	V CW
	PD	Vr_PD	5	V CW
Operating case temperature	Tc	-10 to +85	°C	CW
		-10 to +85	°C	pulse ¹⁾
Storage temperature	Tstg	-40 to +85	°C	

Note) 1)Pulse drive condition: Pulse width \leq 100ns, duty \leq 50%

Electrical and Optical Characteristics

T=25°C, CW, Po=175 mW

Item	Symbol	Min.	Typ.	Max.	Unit	Condition	
Threshold current	I _{th}	30	45	65	mA		
Operating current	I _{op}	180	210	265	mA		
Operating voltage	V _{op}	2.0	2.5	3.0	V		
Monitoring Current	I _m	0.2	0.65	1.6	mA		
Wavelength	λ	777	783	791	Nm		
Beam divergence	Parallel	θ_h	6.0	8.5	11.5	deg	FWHM
	Perpendicular	θ_v	12.0	16.0	19.0	deg	FWHM

FWHM: Full width at half maximum

Typical Characteristics

Output Power vs Current (CW)

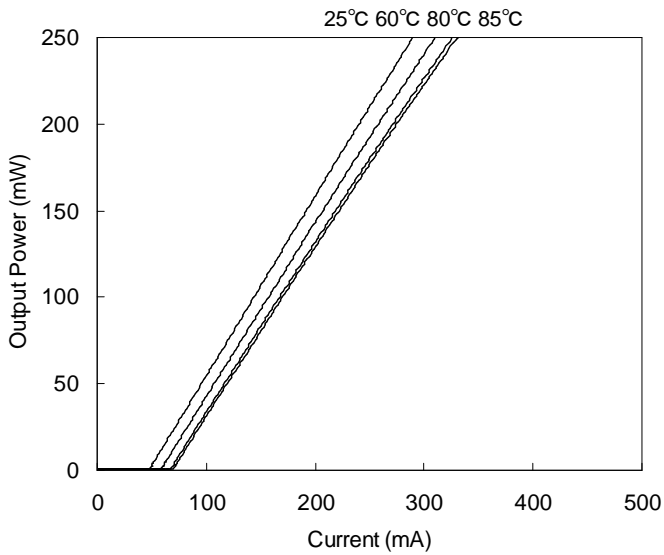

Voltage vs Current (CW)

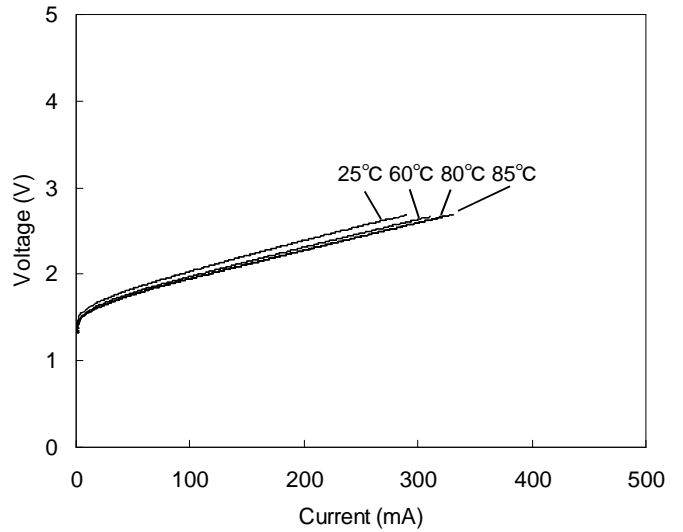

Output Power vs Current (Pulse)

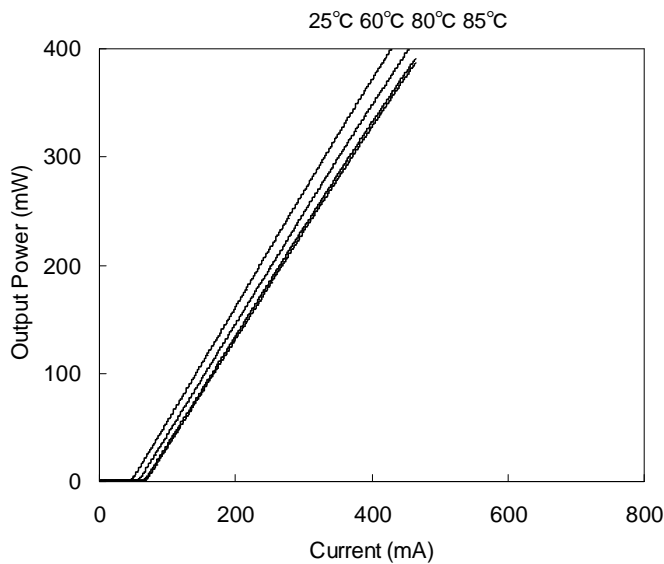

Voltage vs Current (Pulse)

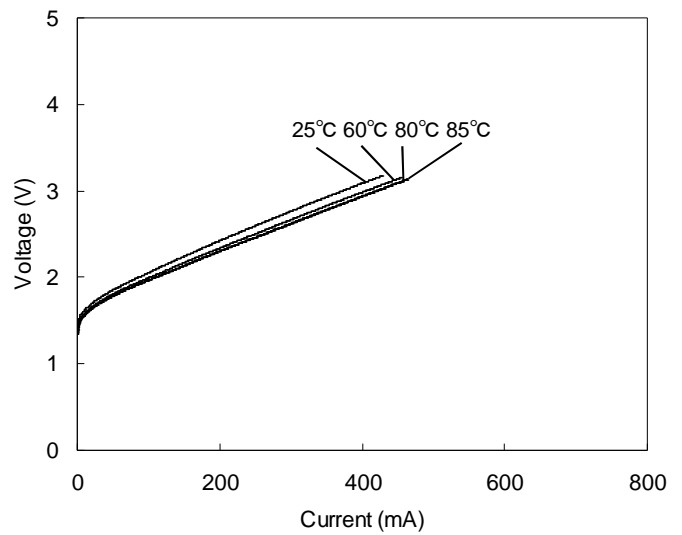

Typical Characteristics

Beam Divergence
Parallel to the Junction (CW)

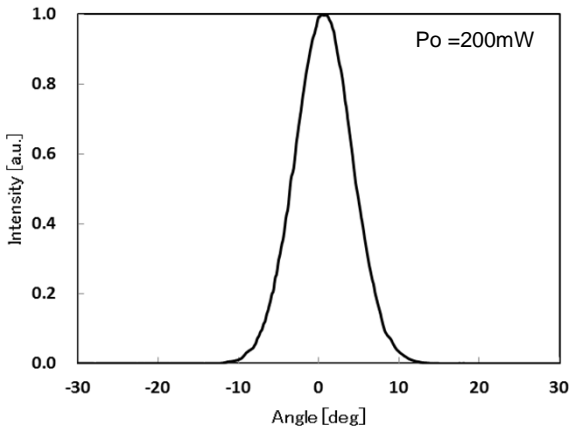

Beam Divergence
Perpendicular to the Junction (CW)

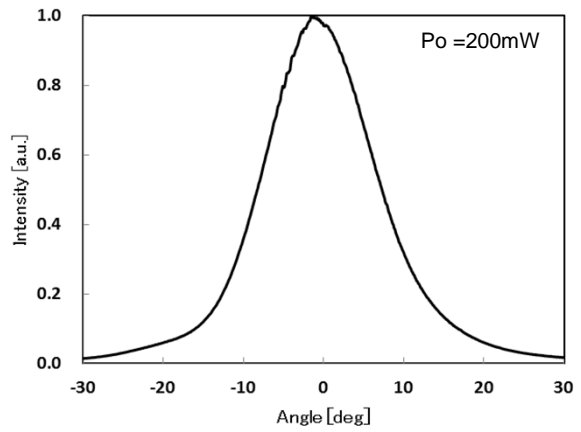

Beam Divergence of Parallel
to the Junction vs Output Power (CW)

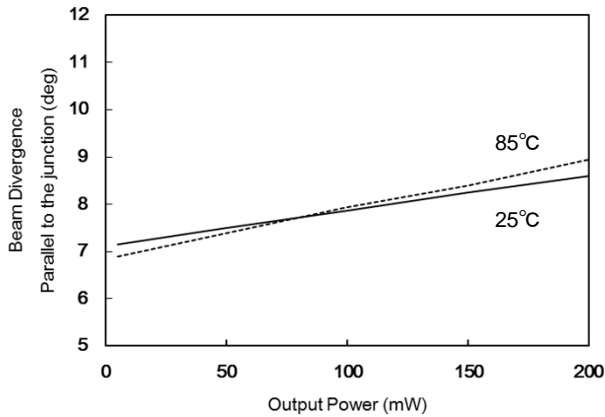

Beam Divergence of Perpendicular
to the Junction vs Output Power (CW)

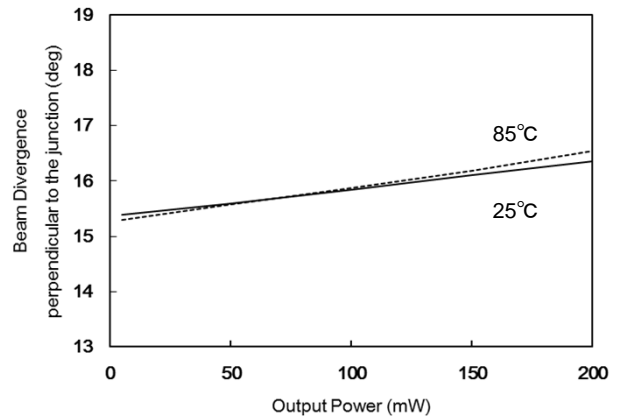

Wavelength vs Temperature (CW)

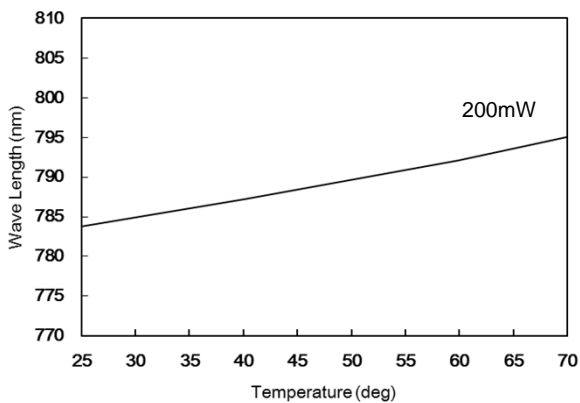

Monitoring Current vs Output Power (CW)

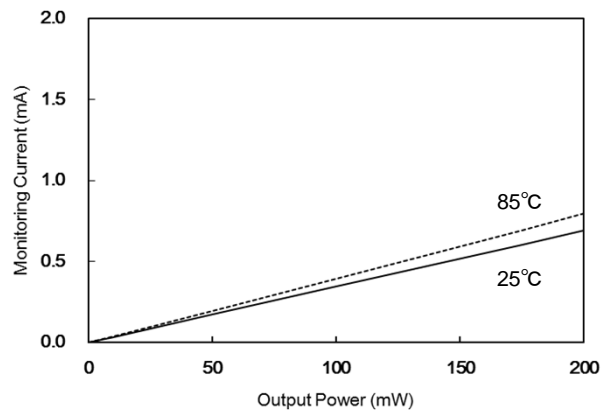

Package Dimensions

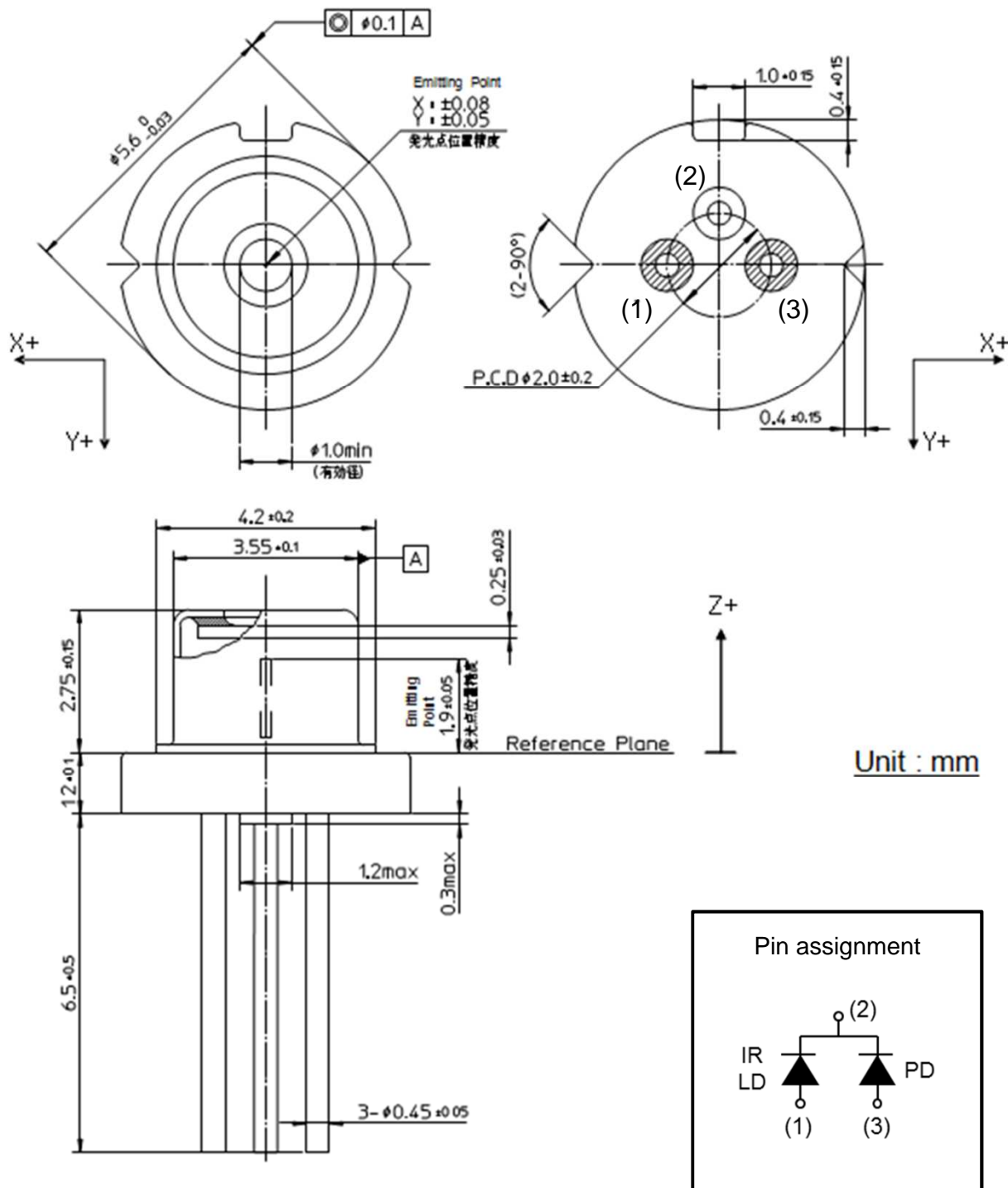

Note)

1. X-Y tolerance of lead is specified on the package bottom plane.

Packing Specifications

1 Packing Material

1.1 Tray

Material: PS Conductive (Black)

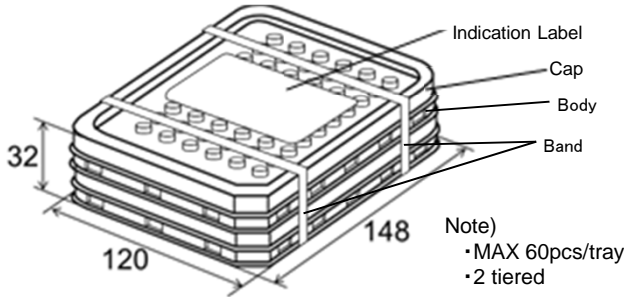

1.2 Laminated Aluminum Pack

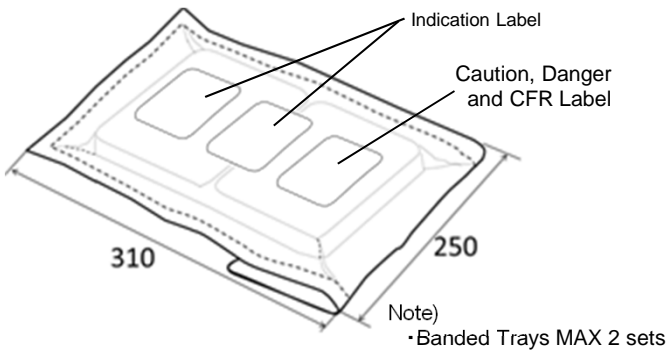

1.3 Packing Case

Material: Corrugated fiber board

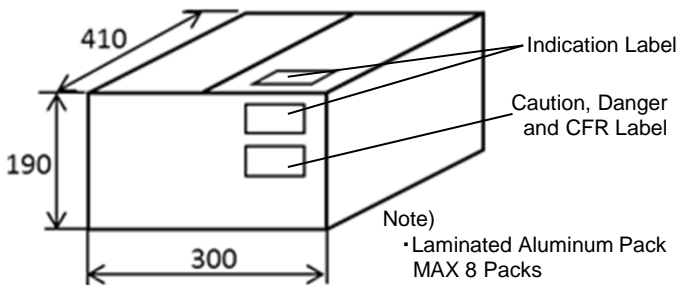

※As for label indication except ①(Order person part number), ②(Order person part number and Quantity), ③(Serial number and Corporate code), and ④(Quantity), the information only for our process control. Therefore, revision might be done for improvement without notice.

2 Packaging Quantity

Form	Quantity	Contents
Tray	n=60	--
Laminated Aluminum Pack	n=240	Tray: 4
Packing Case	n=240 to 1920	Aluminum Pack: 1 to 8

1) Indication on Top Tray

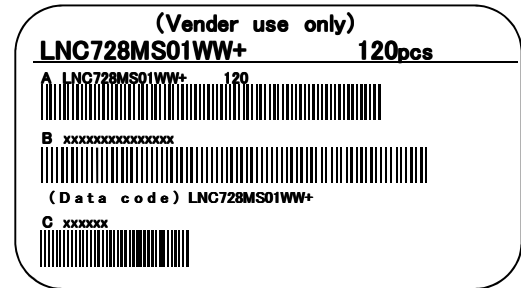

2) Indication on Laminated Pack

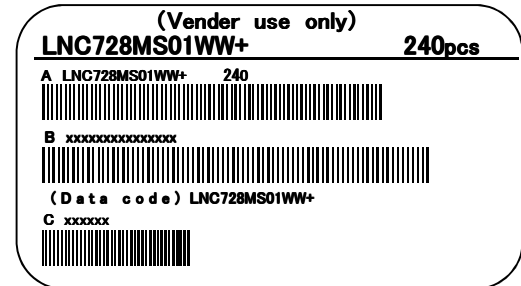
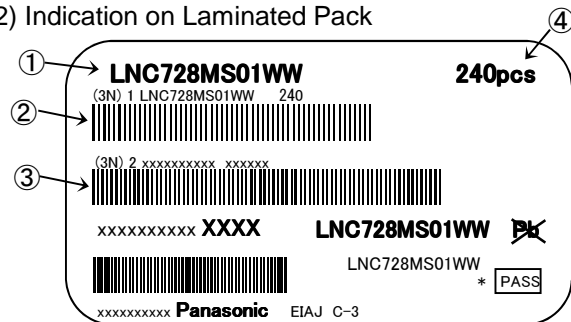

3) Indication on packing case

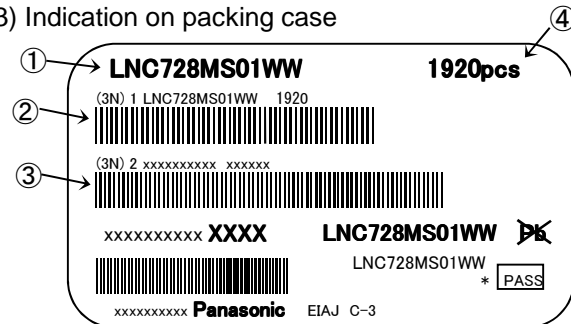

Warning

■ Laser class

This product is ranked "Class IIIb laser" according to IEC60825-1 and JIS standard 6802 "Laser Product Emission Safety Standards," so that safety protection is necessary when laser beam is radiated.

Cautions

■ TO-56 CAN packaged laser diode

This product uses a TO-56 CAN package to ensure versatile use.

■ Prevention of Electrostatic discharge (ESD) and surge stress

Semiconductor laser diode is a device sensitive to ESD and surge, so that sufficient cautions are needed. If electrostatic discharge is applied to a laser diode, intensive light emission may occur instantaneously, leading to the potential for catastrophic damage in the laser diode or degradation of the laser diode in a short time. Therefore, taking all possible measures against ESD and surge for usage of CAN packaged laser diode is strongly requested.

■ Heat sink design

As case temperature becomes higher, the life of semiconductor laser diode becomes shorter. So appropriate heat dissipation design is required. Especially it is effective to make a thermal connection to the highly thermally conductive heat sink at the base plate of a TO56 package.

■ Precautions for soldering

Excess heating to laser diode package during soldering may affect eutectic solder and/or laser diode itself. Soldering must be done as quickly as possible with controlling the heating temperature. Lead(terminal) soldering with appropriate cooling time is strongly recommended. Also, soldering position of lead(terminal) is recommended to be more than 2mm away from the package body.

- Soldering temperature: below 350°C
- Heating period: within 3 s
- Soldering position: 2mm away from the package body



Caution for Safety



DANGER

Do not touch or look into the laser beam directly.

The laser beam may cause injury to the eye or skin, or loss of eyesight.

Request for your special attention and precautions in using the technical information and semiconductors described in this book

- (1) If any of the products or technical information described in this book is to be exported or provided to non-residents, the laws and regulations of the exporting country, especially, those with regard to security export control, must be observed.
- (2) The technical information described in this book is intended only to show the main characteristics and application circuit examples of the products. No license is granted in and to any intellectual property right or other right owned by Panasonic Corporation, Nuvoton Technology Corporation Japan or any other company. Therefore, no responsibility is assumed by our company as to the infringement upon any such right owned by any other company which may arise as a result of the use of technical information de-scribed in this book.
- (3) The products described in this book are intended to be used for general applications (such as office equipment, communications equipment, measuring instruments and household appliances), or for specific applications as expressly stated in this book.
Please consult with our sales staff in advance for information on the following applications, moreover please exchange documents separately on terms of use etc.: Special applications (such as for in-vehicle equipment, airplanes, aerospace, automotive equipment, traffic signaling equipment, combustion equipment, medical equipment and safety devices) in which exceptional quality and reliability are required, or if the failure or malfunction of the products may directly jeopardize life or harm the human body.
Unless exchanging documents on terms of use etc. in advance, it is to be understood that our company shall not be held responsible for any damage incurred as a result of or in connection with your using the products described in this book for any special application.
- (4) The products and product specifications described in this book are subject to change without notice for modification and/or improvement. At the final stage of your design, purchasing, or use of the products, therefore, ask for the most up-to-date Product Standards in advance to make sure that the latest specifications satisfy your requirements.
- (5) When designing your equipment, comply with the range of absolute maximum rating and the guaranteed operating conditions (operating power supply voltage and operating environment etc.). Especially, please be careful not to exceed the range of absolute maximum rating on the transient state, such as power-on, power-off and mode-switching. Otherwise, we will not be liable for any defect which may arise later in your equipment.
Even when the products are used within the guaranteed values, take into the consideration of incidence of break down and failure mode, possible to occur to semiconductor products. Measures on the systems such as redundant design, arresting the spread of fire or preventing glitch are recommended in order to prevent physical injury, fire, social damages, for example, by using the products.
- (6) Comply with the instructions for use in order to prevent breakdown and characteristics change due to external factors (ESD, EOS, thermal stress and mechanical stress) at the time of handling, mounting or at customer's process. We do not guarantee quality for disassembled products or the product re-mounted after removing from the mounting board.
When using products for which damp-proof packing is required, satisfy the conditions, such as shelf life and the elapsed time since first opening the packages.
- (7) When reselling products described in this book to other companies without our permission and receiving any claim of request from the resale destination, please understand that customers will bear the burden.
- (8) This book may be not reprinted or reproduced whether wholly or partially, without the prior written permission of our company.

No.070920

单击下面可查看定价，库存，交付和生命周期等信息

[>>Panasonic\(松下\)](#)