

Surface Mounting Chip LED

3216 Type

Conventional Part No. Global Part No. Lighting Color
 LNJ211R8ARA LNJ211R8ARA Red
 LNJ311G8TRA LNJ311G8TRA Green
 LNJ411K8YRA LNJ411K8YRA Amber

■ Absolute Maximum Ratings ($T_a = 25^\circ\text{C}$)

Lighting Color	P_D (mW)	I_F (mA)	I_{FP} (mA)*	V_R (V)	T_{opr} ($^\circ\text{C}$)	T_{stg} ($^\circ\text{C}$)
Red	60	20	100	3	-30 ~ +85	-40 ~ +100
Green	60	20	100	4	-30 ~ +85	-40 ~ +100
Amber	60	20	100	4	-30 ~ +85	-40 ~ +100

I_{FP} の条件は duty 10% , Pulse width 1 msec. The condition of I_{FP} is duty 10%, Pulse width 1 msec

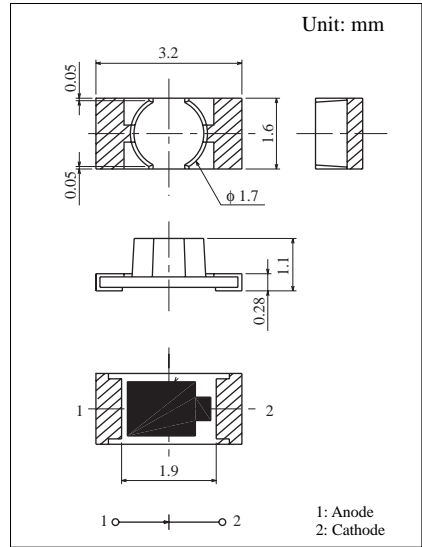

■ Electro-Optical Characteristics ($T_a = 25^\circ\text{C}$)

Conventional Part No.	Lighting Color	Lens Color	I_O		I_F	V_F		λ_P	$\Delta\lambda$	I_F	I_R	
			Typ	Min		Typ	Max				Max	V_R
LNJ211R8ARA	Red	Red Diffused	7.0	2.3	10	1.72	2.5	660	20	10	100	3
LNJ311G8TRA	Green	Green Diffused	5.5	1.8	10	2.03	2.6	565	30	10	10	4
LNJ411K8YRA	Amber	Yellow Diffused	2.2	0.75	10	2.0	2.6	590	30	10	10	4
Unit	—	—	mcd	mcd	mA	V	V	nm	nm	mA	μA	V

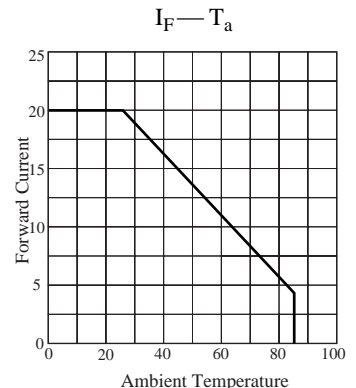
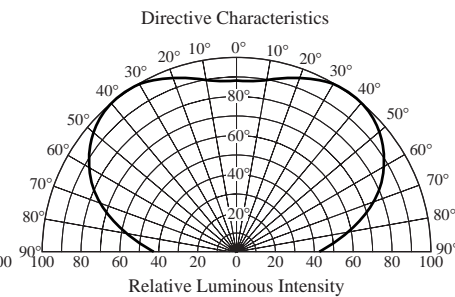
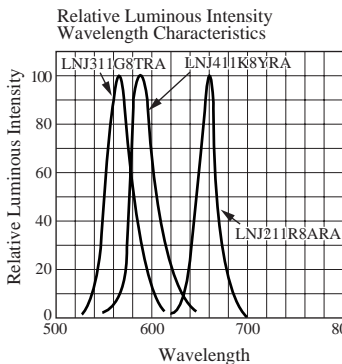
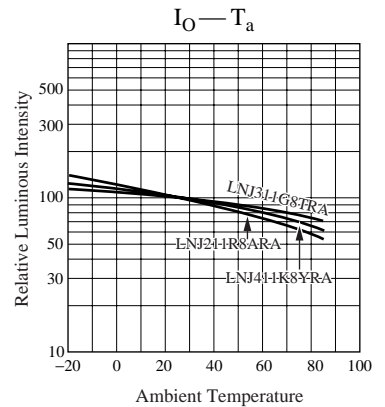
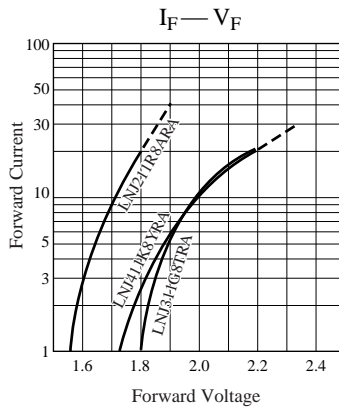
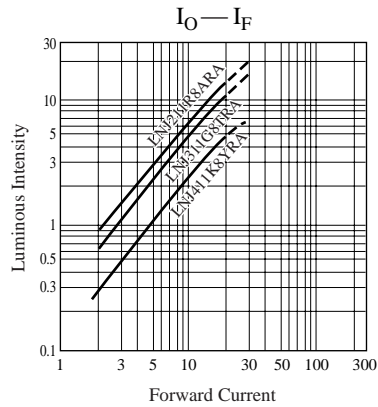

单击下面可查看定价，库存，交付和生命周期等信息

[>>Panasonic\(松下\)](#)