

Approved	Checked	Designed	DEVELOPMENT SPECIFICATION							
<i>T. Okada</i>	<i>M. Hiji</i>	<i>K. Sakurai</i>	P/N: LNJ310C63RA				18			4
T Y P E			Green Light Emitting Diode							
APPLICATION			Indicators							
MATERIAL			InGaAlP							
OUTLINE			Attached							
ABSOLUTE MAXIMUM RATINGS			P	※ I <sub>FP</sub>	I <sub>FDC</sub>	V <sub>R</sub>	Topr	Tstg		
			50	60	20	4	-25~+80	-30~+85		
			mW	mA	mA	V	°C	°C		
CONDITION			T <sub>a</sub> = 25 ± 3°C							
Test Specification										
Item	Symbol	Condition	Typ	Limit		Unit				
				Min	Max					
Forward Voltage	V <sub>F</sub>	I <sub>F</sub> = 10 mA	2.0		2.5	V				
Reverse Leakage Current	I <sub>R</sub>	V <sub>R</sub> = 4 V			100	μA				
Luminous Intensity	I <sub>O</sub>	I <sub>F</sub> = 10 mA · DC	15	7.7		mcđ				
Peak Emission Wavelength	λ <sub>p</sub>	I <sub>F</sub> = 10 mA · DC	575			nm				
Spectral Line Half Width	Δλ	I <sub>F</sub> = 10 mA · DC	15			nm				
<p>*1. The Condition of pulse current I<sub>FP</sub> is 1 ms pulse width, 10 % duty cycle.</p> <p>*2. Tolerance of luminous intensity ±20 %.</p> <p>· Please contact the Panasonic local office if you design at low current (below 1 mA DC) or pulse current operation and have any questions.</p>										
NOTE										
<p>★1. Soldering conditions. Refer to Handling note.</p> <p>★2. Care should be taken that soldering is done within 3-days after opening the dry package and reel.</p> <p>★3. This LED is sensitive to static electricity and care should be fully taken in handling it. Particularly, when an overvoltage is applied, which exceeds the absolute maximum rating of the LED, its energy damages the LED. Therefore, take utmost proactive measures against static electricity and surge as to building an assembly line and handling the LED halfway the process.</p> <p>(1) Check the entire drive circuit including the power source. For example, a surge current, etc., generated at power-on/off must not exceed the absolute maximum rating of the LED. Also, insert an appropriate protective circuit into the LED drive circuit.</p> <p>(2) Beware of destruction by static electricity in handling the LED. As proactive measures against static electricity, it is effective to earth your body (via 1MΩ), spread conductive mat on the floor, wear semiconductive work uniform and shoes, and use semiconductive containers. Also, be sure to earth the nose of a soldering iron. It is recommended to use an ionizer, etc., in the facility or environment where static electricity may be generated easily.</p>										
Feb. 16. 2001										

Approved <i>Tokuda</i>	Checked <i>M. H.</i>	Designed <i>K. Akita</i>
---------------------------	-------------------------	-----------------------------

DEVELOPMENT SPECIFICATION

P/N: LNJ310C63RA

18

5

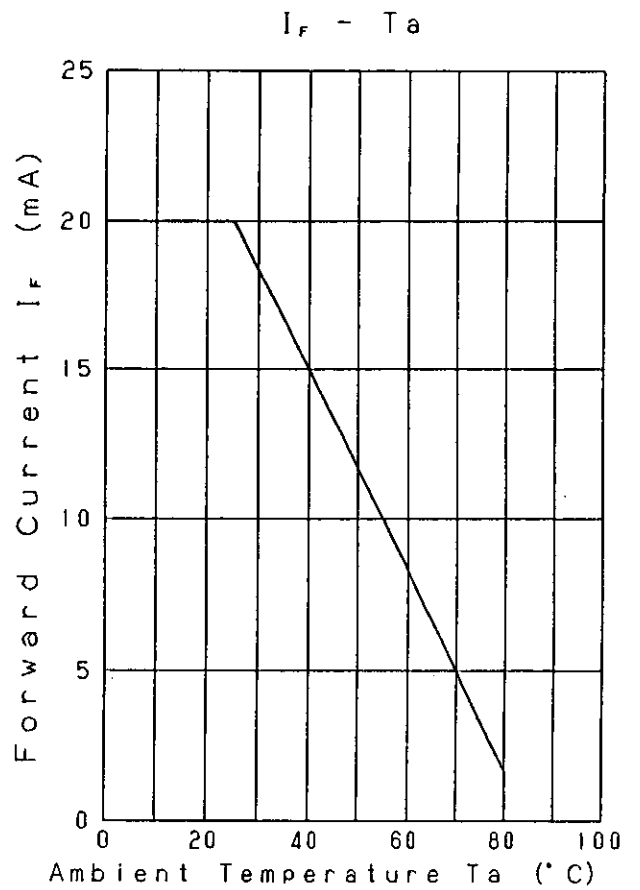
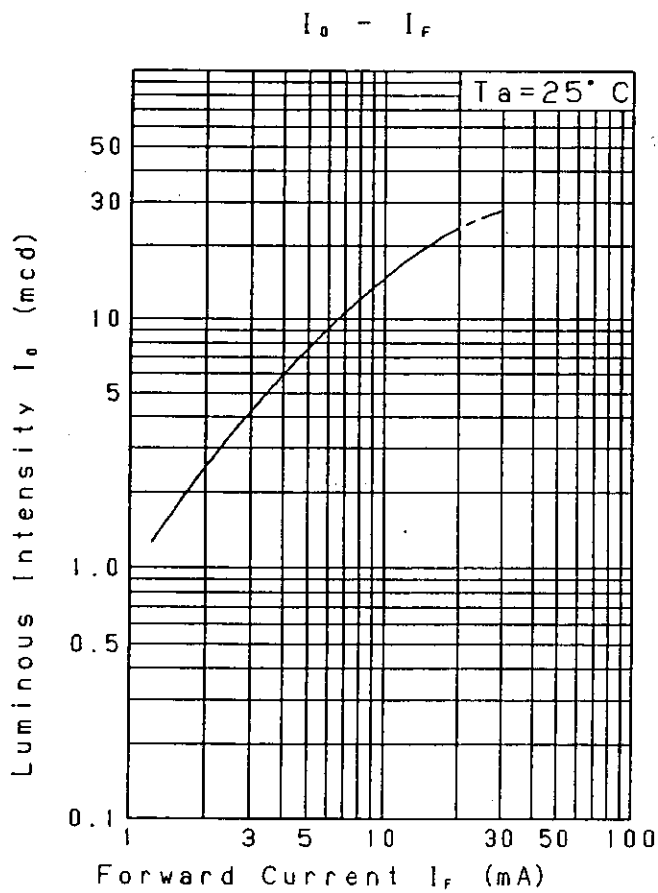
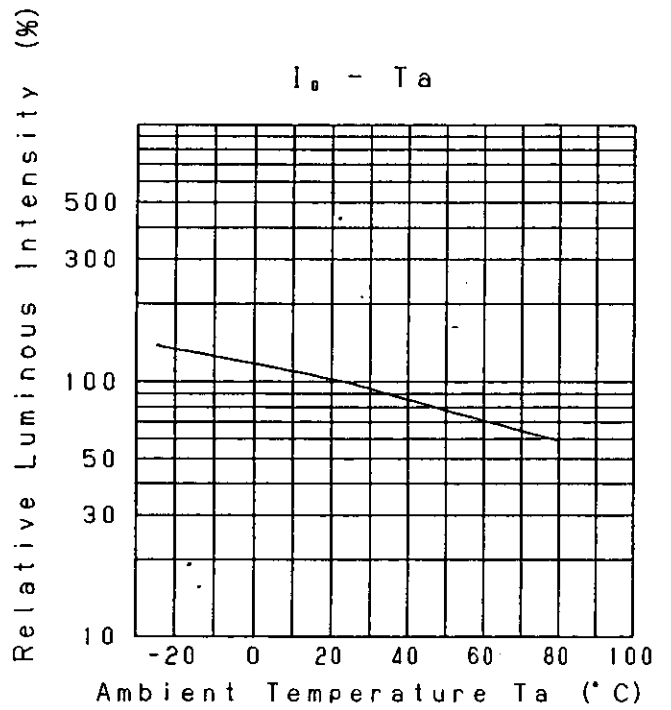
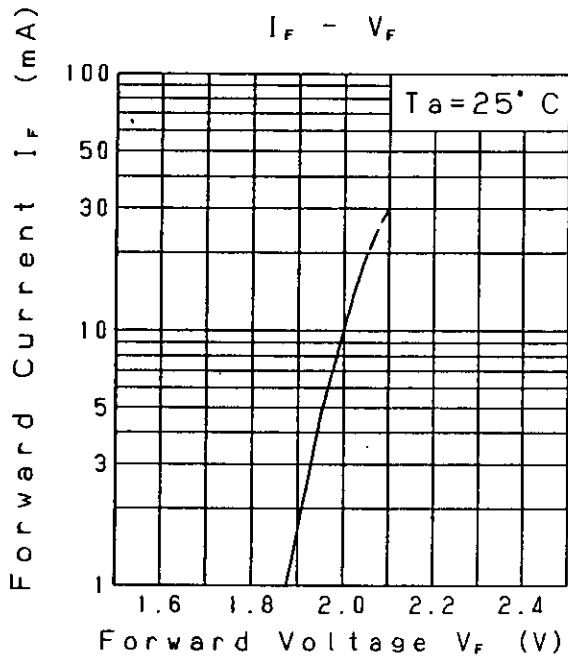

Feb.16.2001

*T. Akeda* | *H. Ho* | *K. Sakurai*

P/N: LNJ310C63RA

18

6

Relative Luminous Intensity Wavelength Characteristics

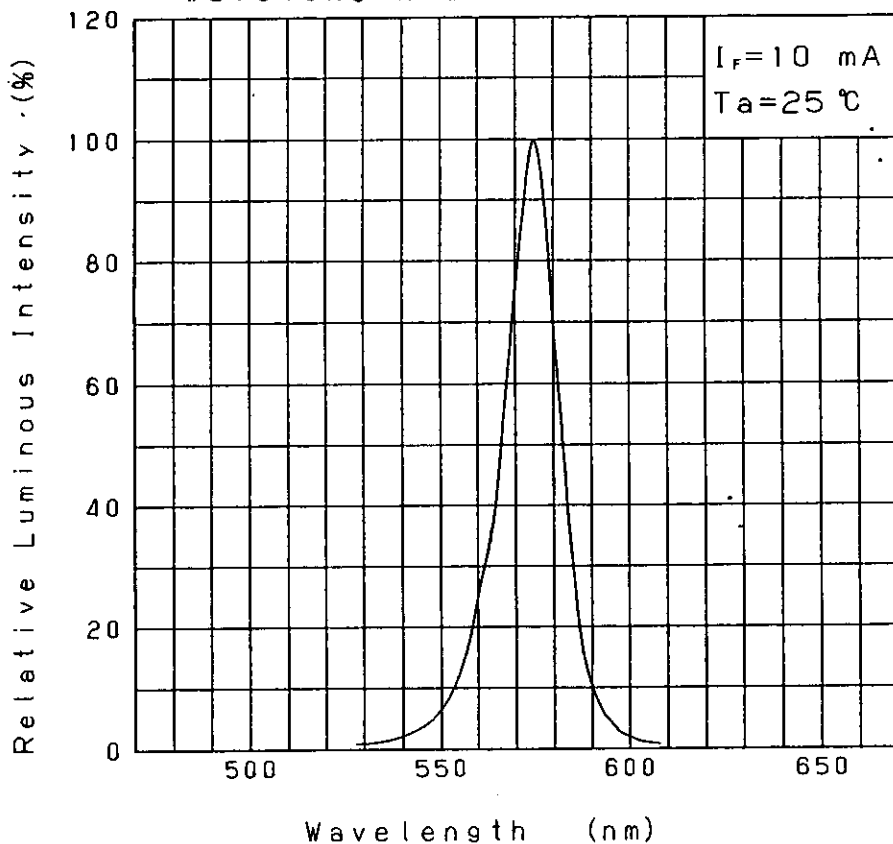

Directive Characteristics

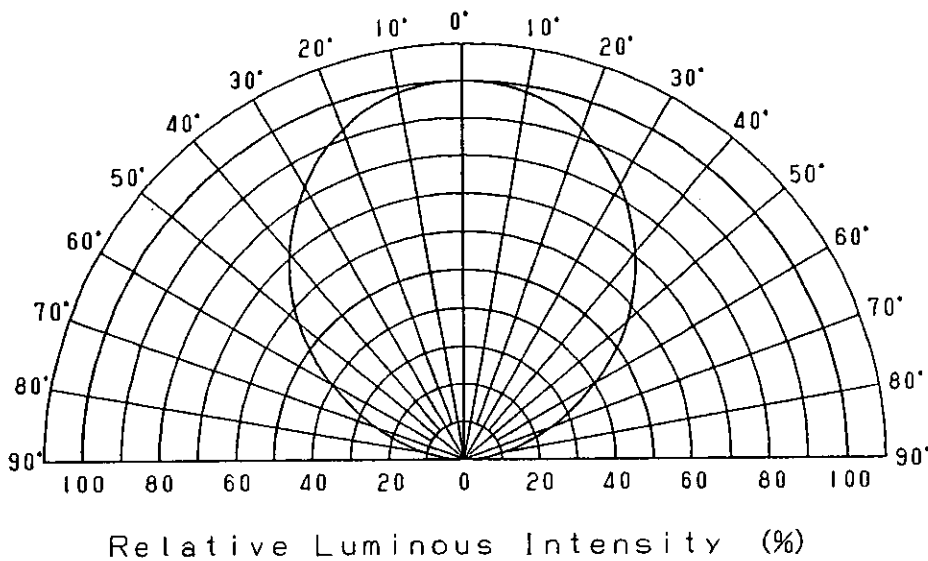

Feb.16.2001

T. Okada  
M. W.  
K. Sakashita

DEVELOPMENT SPECIFICATION  
(OUTLINE)  
P/N:LNJ310C63RA

18

7

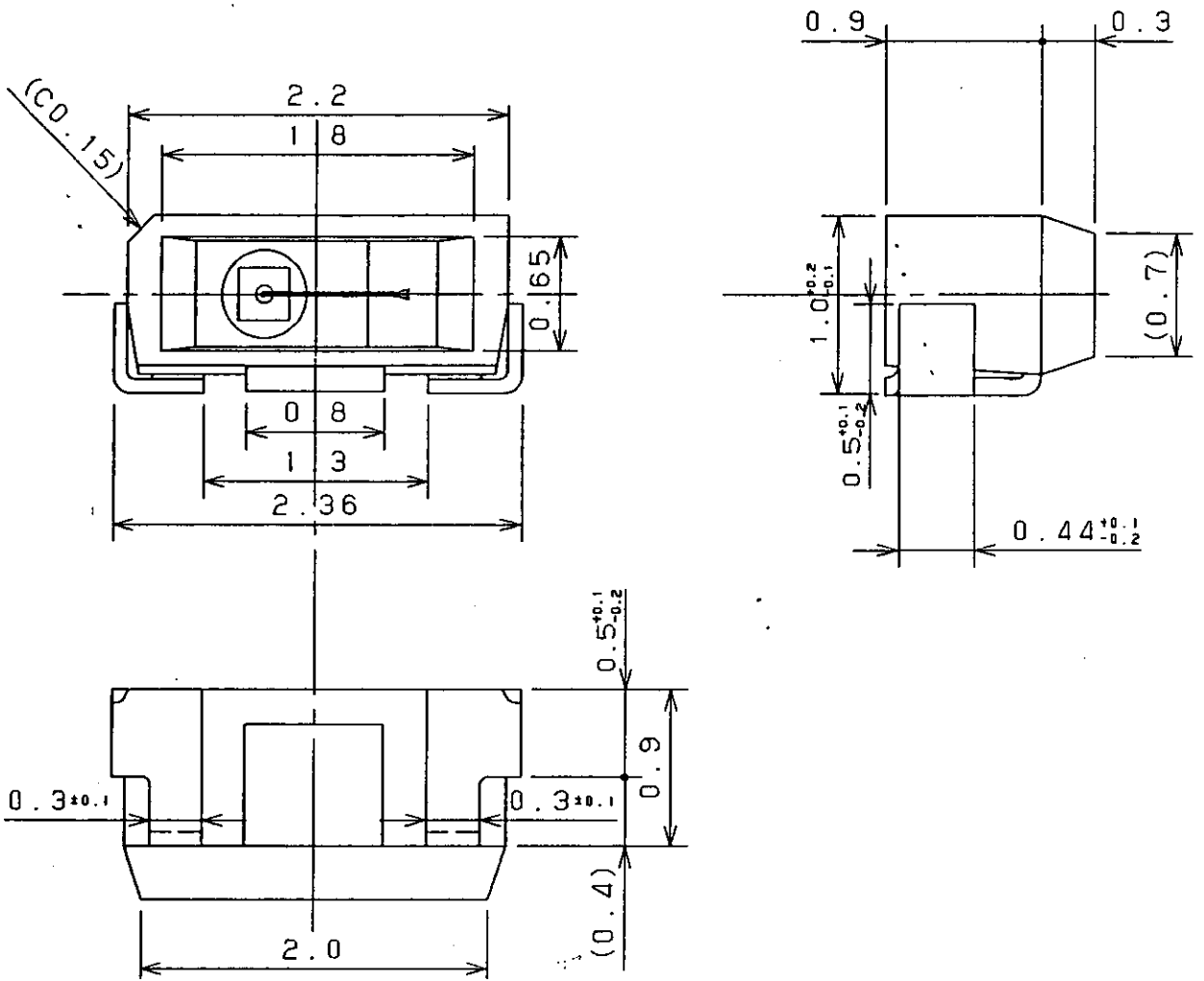

Recommended Land Layout

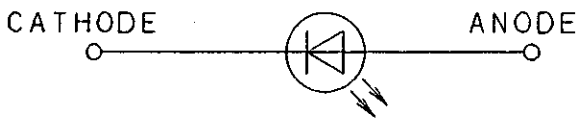
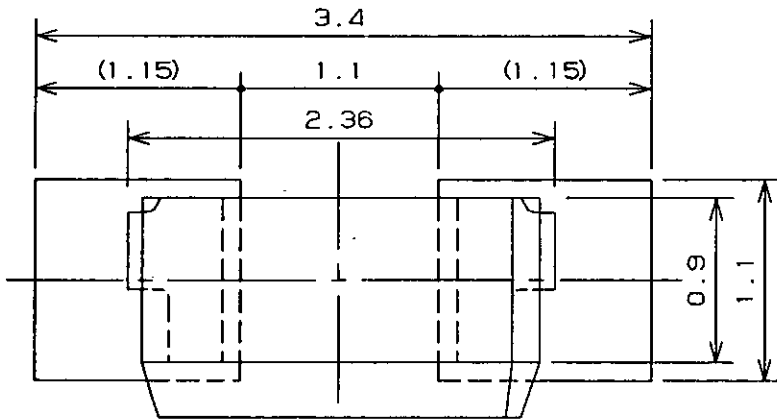

(NOTE)  
1. Unit: mm  
2. Tolerance unless specified is ±0.15.

Feb. 16. 2001

Panasonic

KAGOSHIMA MATSUSHITA ELECTRONICS CO., LTD.

KB-H-022-016B

单击下面可查看定价，库存，交付和生命周期等信息

[>>Panasonic\(松下\)](#)