

# Active infrared (area reflective) human detection sensor

# MA MOTION SENSOR

## FEATURES

- 1. Now even more miniature.**  
The new thin type cuts 35% from the thickness of the previous short type. Device installing is now easier than ever.
- 2. Certain detection unaffected by the reflectance of the object**  
The sensor can provide stable detection that is not affected by the condition (color or material of the clothing) or parts (skin, hair, etc.) of the object being monitored. (Reflectance 18% to 90%). Excellent performance even when the detection surface is dirty.
- 3. Only connecting DC power supply for operating**  
Built-in oscillation circuit type obviates the hitherto existing need for start signal input.
- 4. Use in adjacent positions is possible**  
These sensors can be located in adjacent positions, because the timing of the external trigger signals can be adjusted so that the beam frequency of each adjacent sensor will not interfere with the other.

## APPLICATIONS

- 1. Water-based product market**
  - Automatic lighting of wash basin units
  - Toilets
  - Automatic water flow from faucets
- 2. Stores and financial instructions**
  - Automatic doors
  - Automatic lighting
  - Cash dispensing machines
  - Automatic teller machines
  - Visitor detecting sensors
- 3. Amusement market**
  - Automatic lighting for game display
- 4. Medical field**
  - Non-contact switch



**RoHS compliant**

## ORDERING INFORMATION

AM

A: Thin short type MA Motion sensor  
BA: MA Motion sensor

Detection distance type (shape)  
1: Short type  
2: Middle type  
3: Long type

Triggering function  
1: External triggering type  
4: Built-in oscillation circuit type (Internal trigger)

Classification by output method & mounting direction  
0: NPN open collector/H type  
5: NPN open collector/V type  
6: PNP open collector/V type

Operating voltage  
2: Free-ranging power type (5.5 to 27V DC)  
9: 5V DC type (4.5 to 5.5V DC)

Rated detection distance

| Part No.        | cm inch     |              |              |              |              |              |  |              |   |               |               |               |               |               |               |               |               |               |  |  |
|-----------------|-------------|--------------|--------------|--------------|--------------|--------------|--|--------------|---|---------------|---------------|---------------|---------------|---------------|---------------|---------------|---------------|---------------|--|--|
|                 | 02          | 03           | 04           | 05           | 06           | 07           | 08<br>(Middle type<br>does not<br>need 08) | 09           | 10<br>(Short type<br>does not<br>need 10) | 11            | 12            | 13            | 14            | 15            | 16            | 17            | 18            | 19            | 20<br>(Long type<br>does not<br>need 20) |  |
| Thin short type | —           | —            | —            | 5<br>1.969   | —            | —            | —  | —            | 10<br>3.937                               | —             | —             | —             | —             | 15<br>5.906   | —             | —             | —             | —             | —  |  |
| Short type      | —           | —            | —            | 5<br>1.969   | 6<br>2.362   | 7<br>2.756   | 8<br>3.150                                 | 9<br>3.543   | 10<br>3.937                               | —             | —             | —             | —             | —             | —             | —             | —             | —             | —  |  |
| Middle type     | 20<br>7.874 | 30<br>11.811 | 40<br>15.748 | 50<br>19.685 | 60<br>23.622 | 70<br>27.559 | 80<br>31.496                               | —            | —   | —             | —             | —             | —             | —             | —             | —             | —             | —             | —  |  |
| Long type       | —           | 30<br>11.811 | 40<br>15.748 | 50<br>19.685 | 60<br>23.622 | 70<br>27.559 | 80<br>31.496                               | 90<br>35.433 | 100<br>39.37                              | 110<br>43.307 | 120<br>47.244 | 130<br>51.181 | 140<br>55.118 | 150<br>59.055 | 160<br>62.992 | 170<br>66.929 | 180<br>70.866 | 190<br>74.803 | 200<br>78.74                             |  |

# MA Motion Sensor (AMA1, AMBA1, 2, 3)

## PRODUCT TYPES

### 1. Detection distance type (distance limited)

#### 1) Thin short type (V type)

| Operating voltage | Output method             | Rated detection distance | Built-in oscillation circuit type |  | External triggering type |  |
|-------------------|---------------------------|--------------------------|-----------------------------------|--|--------------------------|--|
|                   |                           |                          | Part No.                          |  | Part No.                 |  |
| 4.5 to 5.5 V DC   | NPN open collector output | 5 cm 1.969 inch          | AMA145905                         |  | AMA115905                |  |
|                   |                           | 10 cm 3.937 inch         | AMA1459                           |  | AMA1159                  |  |
|                   |                           | 15 cm 5.906 inch         | AMA145915                         |  | AMA115915                |  |
|                   | PNP open collector output | 5 cm 1.969 inch          | AMA146905                         |  | AMA116905                |  |
|                   |                           | 10 cm 3.937 inch         | AMA1469                           |  | AMA1169                  |  |
|                   |                           | 15 cm 5.906 inch         | AMA146915                         |  | AMA116915                |  |

Standard packing: Carton: 20 pcs.; Case: 200 pcs.

Note: If you plan to use multiple sensors side-by-side, or you wish to keep the current consumption small, inquire for details about external trigger type, which is suitable for such applications.

#### 2) Short type (H type)

| Rated operating voltage | Rated detection distance | Mounting direction: H type        |  |                          |  |
|-------------------------|--------------------------|-----------------------------------|--|--------------------------|--|
|                         |                          | Short type                        |  |                          |  |
|                         |                          | Built-in oscillation circuit type |  | External triggering type |  |
|                         |                          | Part No.                          |  | Part No.                 |  |
| 4.5 to 5.5 V DC         | 5 cm 1.969 inch          | AMBA140905                        |  | AMBA110905               |  |
|                         | 6 cm 2.362 inch          | AMBA140906                        |  | AMBA110906               |  |
|                         | 7 cm 2.756 inch          | AMBA140907                        |  | AMBA110907               |  |
|                         | 8 cm 3.150 inch          | AMBA140908                        |  | AMBA110908               |  |
|                         | 9 cm 3.543 inch          | AMBA140909                        |  | AMBA110909               |  |
|                         | 10 cm 3.937 inch         | AMBA1409                          |  | AMBA1109                 |  |
| 5.5 to 27 V DC          | 5 cm 1.969 inch          | AMBA140205                        |  | AMBA110205               |  |
|                         | 6 cm 2.362 inch          | AMBA140206                        |  | AMBA110206               |  |
|                         | 7 cm 2.756 inch          | AMBA140207                        |  | AMBA110207               |  |
|                         | 8 cm 3.150 inch          | AMBA140208                        |  | AMBA110208               |  |
|                         | 9 cm 3.543 inch          | AMBA140209                        |  | AMBA110209               |  |
|                         | 10 cm 3.937 inch         | AMBA1402                          |  | AMBA1102                 |  |

Standard packing: Carton: 20 pcs.; Case: 200 pcs.

Note: If you plan to use multiple sensors side-by-side, or you wish to keep the current consumption small, inquire for details about external trigger type, which is suitable for such applications.

#### 3) Middle type (H type)

| Rated operating voltage | Rated detection distance | Mounting direction: H type        |  |                          |  |
|-------------------------|--------------------------|-----------------------------------|--|--------------------------|--|
|                         |                          | Middle type                       |  |                          |  |
|                         |                          | Built-in oscillation circuit type |  | External triggering type |  |
|                         |                          | Part No.                          |  | Part No.                 |  |
| 4.5 to 5.5 V DC         | 20 cm 7.874 inch         | AMBA240902                        |  | AMBA210902               |  |
|                         | 30 cm 11.811 inch        | AMBA240903                        |  | AMBA210903               |  |
|                         | 40 cm 15.748 inch        | AMBA240904                        |  | AMBA210904               |  |
|                         | 50 cm 19.685 inch        | AMBA240905                        |  | AMBA210905               |  |
|                         | 60 cm 23.622 inch        | AMBA240906                        |  | AMBA210906               |  |
|                         | 70 cm 27.559 inch        | AMBA240907                        |  | AMBA210907               |  |
|                         | 80 cm 31.496 inch        | AMBA2409                          |  | AMBA2109                 |  |
| 5.5 to 27 V DC          | 20 cm 7.874 inch         | AMBA240202                        |  | AMBA210202               |  |
|                         | 30 cm 11.811 inch        | AMBA240203                        |  | AMBA210203               |  |
|                         | 40 cm 15.748 inch        | AMBA240204                        |  | AMBA210204               |  |
|                         | 50 cm 19.685 inch        | AMBA240205                        |  | AMBA210205               |  |
|                         | 60 cm 23.622 inch        | AMBA240206                        |  | AMBA210206               |  |
|                         | 70 cm 27.559 inch        | AMBA240207                        |  | AMBA210207               |  |
|                         | 80 cm 31.496 inch        | AMBA2402                          |  | AMBA2102                 |  |

Standard packing: Carton: 20 pcs.; Case: 200 pcs.

Note: If you plan to use multiple sensors side-by-side, or you wish to keep the current consumption small, inquire for details about external trigger type, which is suitable for such applications.

# MA Motion Sensor (AMA1, AMBA1, 2, 3)

## 4) Long type

| Rated operating voltage | Rated detection distance | Mounting direction: H type        |                          | Mounting direction: V type        |                          |
|-------------------------|--------------------------|-----------------------------------|--------------------------|-----------------------------------|--------------------------|
|                         |                          | Long type                         |                          |                                   |                          |
|                         |                          | Built-in oscillation circuit type | External triggering type | Built-in oscillation circuit type | External triggering type |
|                         |                          | Part No.                          | Part No.                 | Part No.                          | Part No.                 |
| 4.5 to 5.5 V DC         | 30 cm 11.811 inch        | AMBA340903                        | AMBA310903               | AMBA345903                        | AMBA315903               |
|                         | 40 cm 15.748 inch        | AMBA340904                        | AMBA310904               | AMBA345904                        | AMBA315904               |
|                         | 50 cm 19.685 inch        | AMBA340905                        | AMBA310905               | AMBA345905                        | AMBA315905               |
|                         | 60 cm 23.622 inch        | AMBA340906                        | AMBA310906               | AMBA345906                        | AMBA315906               |
|                         | 70 cm 27.559 inch        | AMBA340907                        | AMBA310907               | AMBA345907                        | AMBA315907               |
|                         | 80 cm 31.496 inch        | AMBA340908                        | AMBA310908               | AMBA345908                        | AMBA315908               |
|                         | 90 cm 35.433 inch        | AMBA340909                        | AMBA310909               | AMBA345909                        | AMBA315909               |
|                         | 100 cm 39.370 inch       | AMBA340910                        | AMBA310910               | AMBA345910                        | AMBA315910               |
|                         | 110 cm 43.307 inch       | AMBA340911                        | AMBA310911               | AMBA345911                        | AMBA315911               |
|                         | 120 cm 47.244 inch       | AMBA340912                        | AMBA310912               | AMBA345912                        | AMBA315912               |
|                         | 130 cm 51.181 inch       | AMBA340913                        | AMBA310913               | AMBA345913                        | AMBA315913               |
|                         | 140 cm 55.118 inch       | AMBA340914                        | AMBA310914               | AMBA345914                        | AMBA315914               |
|                         | 150 cm 59.055 inch       | AMBA340915                        | AMBA310915               | AMBA345915                        | AMBA315915               |
|                         | 160 cm 62.992 inch       | AMBA340916                        | AMBA310916               | AMBA345916                        | AMBA315916               |
|                         | 170 cm 66.929 inch       | AMBA340917                        | AMBA310917               | AMBA345917                        | AMBA315917               |
|                         | 180 cm 70.866 inch       | AMBA340918                        | AMBA310918               | AMBA345918                        | AMBA315918               |
| 190 cm 74.803 inch      | AMBA340919               | AMBA310919                        | AMBA345919               | AMBA315919                        |                          |
| 200 cm 78.740 inch      | AMBA3409                 | AMBA3109                          | AMBA3459                 | AMBA3159                          |                          |
| 5.5 to 27 V DC          | 30 cm 11.811 inch        | AMBA340203                        | AMBA310203               | AMBA345203                        | AMBA315203               |
|                         | 40 cm 15.748 inch        | AMBA340204                        | AMBA310204               | AMBA345204                        | AMBA315204               |
|                         | 50 cm 19.685 inch        | AMBA340205                        | AMBA310205               | AMBA345205                        | AMBA315205               |
|                         | 60 cm 23.622 inch        | AMBA340206                        | AMBA310206               | AMBA345206                        | AMBA315206               |
|                         | 70 cm 27.559 inch        | AMBA340207                        | AMBA310207               | AMBA345207                        | AMBA315207               |
|                         | 80 cm 31.496 inch        | AMBA340208                        | AMBA310208               | AMBA345208                        | AMBA315208               |
|                         | 90 cm 35.433 inch        | AMBA340209                        | AMBA310209               | AMBA345209                        | AMBA315209               |
|                         | 100 cm 39.370 inch       | AMBA340210                        | AMBA310210               | AMBA345210                        | AMBA315210               |
|                         | 110 cm 43.307 inch       | AMBA340211                        | AMBA310211               | AMBA345211                        | AMBA315211               |
|                         | 120 cm 47.244 inch       | AMBA340212                        | AMBA310212               | AMBA345212                        | AMBA315212               |
|                         | 130 cm 51.181 inch       | AMBA340213                        | AMBA310213               | AMBA345213                        | AMBA315213               |
|                         | 140 cm 55.118 inch       | AMBA340214                        | AMBA310214               | AMBA345214                        | AMBA315214               |
|                         | 150 cm 59.055 inch       | AMBA340215                        | AMBA310215               | AMBA345215                        | AMBA315215               |
|                         | 160 cm 62.992 inch       | AMBA340216                        | AMBA310216               | AMBA345216                        | AMBA315216               |
|                         | 170 cm 66.929 inch       | AMBA340217                        | AMBA310217               | AMBA345217                        | AMBA315217               |
|                         | 180 cm 70.866 inch       | AMBA340218                        | AMBA310218               | AMBA345218                        | AMBA315218               |
| 190 cm 74.803 inch      | AMBA340219               | AMBA310219                        | AMBA345219               | AMBA315219                        |                          |
| 200 cm 78.740 inch      | AMBA3402                 | AMBA3102                          | AMBA3452                 | AMBA3152                          |                          |

Standard packing: Carton: 20 pcs.; Case: 200 pcs.

Note: If you plan to use multiple sensors side-by-side, or you wish to keep the current consumption small, inquire for details about external trigger type, which is suitable for such applications.

## RATING

### 1. Detection performance

1) Thin short type (Measuring conditions: ambient temp.: 25°C 77°F; operating voltage: 5 V DC)

| Items   |                                  | Thin short type                   |                                    |                                    | Measured conditions                        |                            |
|---|----------------------------------|-----------------------------------|------------------------------------|------------------------------------|--|----------------------------|
|   |                                  | 5 cm<br>1.969 inch                | 10 cm<br>3.937 inch                | 15 cm<br>3.937 inch                |  |                            |
| Rated detection distance                                  | Minimum                          | 45 mm                             | 90 mm                              | 135 mm                             | with a standard reflection board*1         |                            |
|   | Typical                          | 1.772 inch<br>50 mm               | 3.543 inch<br>100 mm               | 5.315 inch<br>150 mm               |  |                            |
|   | Maximum                          | 1.969 inch<br>55 mm<br>2.165 inch | 3.937 inch<br>110 mm<br>4.331 inch | 5.906 inch<br>165 mm<br>6.496 inch |  |                            |
| Measuring tolerance                                       |                                  | Typical                           | 10%                                | 25%                                | 35%  | Reflection rate: 90 to 18% |
| Usable ambient brightness (Resistance to ambient light)*2 | Brightness of sensor surface     | Maximum                           | 30,000 lx                          |                                    | See the drawing (Fig. 1) on the next page. |                            |
|   | Brightness of reflection surface | Maximum                           | 24,000 lx                          |                                    |  |                            |

Notes: \*1. Ambient brightness: 500 lx

\*2. Install so that light from direct light sources does not enter the sensor (within 30° of the sensor light beam).

Indicates brightness detectible enough for sensor operation.

# MA Motion Sensor (AMA1, AMBA1, 2, 3)

## 2) Short type (Measuring conditions: ambient temp.: 25°C 77°F; operating voltage: 5 V DC type 5V, Free-ranging power type 24V DC)

| Items   |                                  | Short type*1        |                     |                     |                     |                     |                      | Measured conditions                        |
|---|----------------------------------|---------------------|---------------------|---------------------|---------------------|---------------------|----------------------|--|
|   |                                  | 5 cm<br>1.969 inch  | 6 cm<br>2.362 inch  | 7 cm<br>2.756 inch  | 8 cm<br>3.150 inch  | 9 cm<br>3.543 inch  | 10 cm<br>3.937 inch  |  |
| Rated detection distance                                  | Minimum                          | 45 mm               | 54 mm               | 63 mm               | 72 mm               | 81 mm               | 90 mm                | with a standard reflection board           |
|   | Typical                          | 1.772 inch<br>50 mm | 2.126 inch<br>60 mm | 2.480 inch<br>70 mm | 2.835 inch<br>80 mm | 3.189 inch<br>90 mm | 3.543 inch<br>100 mm |  |
|   | Maximum                          | 1.969 inch<br>55 mm | 2.362 inch<br>66 mm | 2.756 inch<br>77 mm | 3.150 inch<br>88 mm | 3.543 inch<br>99 mm | 3.937 inch<br>110 mm |  |
| Measuring tolerance                                       | Typical                          | 10%                 |                     | 15%                 | 20%                 |                     | 25%                  | Reflection rate: 90 to 18%                 |
| Usable ambient brightness (Resistance to ambient light)*2 | Brightness of sensor surface     | Maximum             |                     |                     |                     |                     |                      | See the drawing (Fig. 1) on the next page. |
|   | Brightness of reflection surface | Maximum             |                     |                     |                     |                     |                      |  |

Notes: \*1. After receipt of order, average rated detection distance to 15 cm 5.906 inch is possible. Please inquire.

\*2. Install so that light from direct light sources does not enter the sensor (within 30° of the sensor light beam).

## 3) Middle type (Measuring conditions: ambient temp.: 25°C 77°F; operating voltage: 5 V DC type 5V, Free-ranging power type 24V DC)

| Items   |                                  | Middle type*1        |                       |                       |                       |                       |                       | Measured conditions                        |                                  |
|---|----------------------------------|----------------------|-----------------------|-----------------------|-----------------------|-----------------------|-----------------------|--|----------------------------------|
|   |                                  | 20 cm<br>7.874 inch  | 30 cm<br>11.811 inch  | 40 cm<br>15.748 inch  | 50 cm<br>19.685 inch  | 60 cm<br>23.622 inch  | 70 cm<br>27.559 inch  |  | 80 cm<br>31.496 inch             |
| Rated detection distance                                  | Minimum                          | 190 mm               | 285 mm                | 380 mm                | 475 mm                | 570 mm                | 665 mm                | 760 mm                                     | with a standard reflection board |
|   | Typical                          | 7.480 inch<br>200 mm | 11.220 inch<br>300 mm | 14.961 inch<br>400 mm | 18.701 inch<br>500 mm | 22.441 inch<br>600 mm | 26.181 inch<br>700 mm | 29.921 inch<br>800 mm                      |                                  |
|   | Maximum                          | 7.874 inch<br>210 mm | 11.811 inch<br>315 mm | 15.748 inch<br>420 mm | 19.685 inch<br>525 mm | 23.622 inch<br>630 mm | 27.559 inch<br>735 mm | 31.496 inch<br>840 mm                      |                                  |
| Measuring tolerance                                       | Typical                          | 3%                   |                       |                       | 5%                    |                       | 10%                   |  | Reflection rate: 90 to 18%       |
| Usable ambient brightness (Resistance to ambient light)*2 | Brightness of sensor surface     | Maximum              |                       |                       |                       |                       |                       | See the drawing (Fig. 1) on the next page. |                                  |
|   | Brightness of reflection surface | Maximum              |                       |                       |                       |                       |                       |  |                                  |

Notes: \*1. After receipt of order, average rated detection distance to 110 cm 43.307 inch is possible. Please inquire.

\*2. Install so that light from direct light sources does not enter the sensor (within 30° of the sensor light beam).

## 4) Long type (Measuring conditions: ambient temp.: 25°C 77°F; operating voltage: 5 V DC type 5V, Free-ranging power type 24V DC)

| Items  |                                  | Long type             |                       |                       |                       |                       |                       |                       |                        | Measured conditions                        |                                  |
|--|----------------------------------|-----------------------|-----------------------|-----------------------|-----------------------|-----------------------|-----------------------|-----------------------|------------------------|--|----------------------------------|
|  |                                  | 30 cm<br>11.811 inch  | 40 cm<br>15.748 inch  | 50 cm<br>19.685 inch  | 60 cm<br>23.622 inch  | 70 cm<br>27.559 inch  | 80 cm<br>31.496 inch  | 90 cm<br>35.433 inch  | 100 cm<br>39.37 inch   |  | 110 cm<br>43.307 inch            |
| Rated detection distance                                 | Minimum                          | 285 mm                | 380 mm                | 475 mm                | 570 mm                | 665 mm                | 760 mm                | 855 mm                | 950 mm                 | 1045 mm                                    | with a standard reflection board |
|  | Typical                          | 11.220 inch<br>300 mm | 14.961 inch<br>400 mm | 18.701 inch<br>500 mm | 22.441 inch<br>600 mm | 26.181 inch<br>700 mm | 29.921 inch<br>800 mm | 33.661 inch<br>900 mm | 37.402 inch<br>1000 mm | 41.142 inch<br>1100 mm                     |                                  |
|  | Maximum                          | 11.811 inch<br>315 mm | 15.748 inch<br>420 mm | 19.685 inch<br>525 mm | 23.622 inch<br>630 mm | 27.559 inch<br>735 mm | 31.496 inch<br>840 mm | 35.433 inch<br>945 mm | 39.37 inch<br>1050 mm  | 43.307 inch<br>1155 mm                     |                                  |
| Measuring tolerance                                      | Typical                          | 3%                    |                       |                       |                       | 5%                    |                       |                       |                        | Reflection rate: 90 to 18%                 |                                  |
| Usable ambient brightness (Resistance to ambient light)* | Brightness of sensor surface     | Maximum               |                       |                       |                       |                       |                       |                       |                        | See the drawing (Fig. 1) on the next page. |                                  |
|  | Brightness of reflection surface | Maximum               |                       |                       |                       |                       |                       |                       |                        |  |                                  |

| Items  |                                  | Long type              |                        |                        |                        |                        |                        |                        |                        | Measured conditions                        |                                  |
|--|----------------------------------|------------------------|------------------------|------------------------|------------------------|------------------------|------------------------|------------------------|------------------------|--|----------------------------------|
|  |                                  | 120 cm<br>47.244 inch  | 130 cm<br>51.181 inch  | 140 cm<br>55.118 inch  | 150 cm<br>59.055 inch  | 160 cm<br>62.992 inch  | 170 cm<br>66.929 inch  | 180 cm<br>70.866 inch  | 190 cm<br>74.803 inch  |  | 200 cm<br>78.74 inch             |
| Rated detection distance                                 | Minimum                          | 1140 mm                | 1235 mm                | 1330 mm                | 1425 mm                | 1520 mm                | 1615 mm                | 1710 mm                | 1805 mm                | 1900 mm                                    | with a standard reflection board |
|  | Typical                          | 44.882 inch<br>1200 mm | 48.622 inch<br>1300 mm | 52.362 inch<br>1400 mm | 56.102 inch<br>1500 mm | 59.842 inch<br>1600 mm | 63.583 inch<br>1700 mm | 67.323 inch<br>1800 mm | 71.063 inch<br>1900 mm | 74.803 inch<br>2000 mm                     |                                  |
|  | Maximum                          | 47.244 inch<br>1260 mm | 51.181 inch<br>1365 mm | 55.118 inch<br>1470 mm | 59.055 inch<br>1575 mm | 62.992 inch<br>1680 mm | 66.929 inch<br>1785 mm | 70.866 inch<br>1890 mm | 74.803 inch<br>1995 mm | 78.74 inch<br>2100 mm                      |                                  |
| Measuring tolerance                                      | Typical                          | 5%                     | 10%                    |                        |                        | 15%                    |                        |                        |                        | Reflection rate: 90 to 18%                 |                                  |
| Usable ambient brightness (Resistance to ambient light)* | Brightness of sensor surface     | Maximum                |                        |                        |                        |                        |                        |                        |                        | See the drawing (Fig. 1) on the next page. |                                  |
|  | Brightness of reflection surface | Maximum                |                        |                        |                        |                        |                        |                        |                        |  |                                  |

Note: \* Install so that light from direct light sources does not enter the sensor (within 30° of the sensor light beam).

# MA Motion Sensor (AMA1, AMBA1, 2, 3)

- For thin short type:  
Standard reflection board: 150 mm 5.906 inch square area, 90% reflection rate.
- For short type:  
Standard reflection board: 100 mm 3.937 inch square area, 90% reflection rate.
- For middle type:  
Standard reflection board: 200 mm 7.874 inch square area, 90% reflection rate.
- For long type:  
Standard reflection board: 500 mm 19.685 inch square area, 90% reflection rate.

Notes: 1. Detecting an object within the maximum preset detection distance.

$$2. \text{Distance deviation} = \frac{a-b}{a} \times 100 (\%)$$

( a: detection distance of detection target with reflectance of 90%.  
b: detection distance of standard detection target with reflectance of 18%. )

<Fig. 1>  
[Brightness of sensor surface]



Note: Light from direct light sources (sunlight, strobe light, inverter illumination, reflected light from glass or mirrors etc.) that enters the sensor from within the prohibited range can cause the sensor to operate erroneously.

[Brightness of reflection surface]



## 2. Absolute maximum rating (Measuring condition: ambient temp.: 25°C 77°F)

| Items                      | Type | Absolute maximum rating                 |                         |   |                         |
|----------------------------|------|---|-------------------------|---|-------------------------|
|                            |      | Built-in oscillation circuit type       |                         | External triggering type                |                         |
|                            |      | 5 V DC type                             | Free-ranging power type | 5 V DC type                             | Free-ranging power type |
| Power supply voltage       |      | -0.3 to 6 V DC                          | -0.3 to 30 V DC         | -0.3 to 6 V DC                          | -0.3 to 30 V DC         |
| Output dielectric strength |      | 30 V                                    |                         | 30 V                                    |                         |
| Output flow current        |      | 100 mA                                  |                         | 10 mA*                                  |                         |
| Usable ambient temperature |      | -25 to +75°C +5 to +131°F (No freezing) |                         | -25 to +75°C +5 to +131°F (No freezing) |                         |
| Storage temperature        |      | -30 to +85°C -4 to +176°F               |                         | -30 to +85°C -4 to +176°F               |                         |

Note: \* Thin short type is only: 100 mA

## 3. Electrical characteristics

(Measuring conditions: ambient temp.: 25°C 77°F; operating voltage: 5 V DC type =5V DC, free-ranging power type =24V DC)

### 1) Built-in oscillation circuit type

| Items                                     | Symbol          | Thin short type*                               |                 | Short type                                       | Middle type  | Long type | Measured conditions     |  |
|---|-----------------|--|-----------------|--|--|-----------|-------------------------|--|
|   |                 | NPN output type                                | PNP output type |  |  |           |                         |  |
| Rated operating voltage                   | Minimum         | 5V DC type: 4.5V/Free-ranging power type: 5.5V |                 |  |  |           |                         |  |
|   | Typical         | —  |                 |  |  |           |                         |  |
|   | Maximum         | 5V DC type: 5.5V/Free-ranging power type: 27V  |                 |  |  |           |                         |  |
| Average current consumption (Iout = 0 mA) | No detection    | Minimum  | —               |  |  |           |                         |  |
|   |                 | Typical  | 4.5mA           | 5V DC type: 4.5mA/Free-ranging power type: 5.6mA |  |           |                         |  |
|   |                 | Maximum  | 6.2mA           | 5V DC type: 6.2mA/Free-ranging power type: 7.8mA |  |           |                         |  |
|   | Detection       | Minimum  | —               |  |  |           |                         |  |
|   |                 | Typical  | 7.0mA           | 11.0mA   | 5V DC type: 7.0mA/Free-ranging power type: 9.1mA   |           |                         |  |
|   |                 | Maximum  | 11.2mA          | 15.2mA   | 5V DC type: 11.2mA/Free-ranging power type: 14.2mA |           |                         |  |
| Measuring cycle                           | Minimum         | T  | 8ms/cycle       |  |  |           |                         |  |
| Output characteristics                    | Remain voltage  | Maximum  | Vr              | 1 V DC   | 1.2 V DC   | 1 V DC    | I <sub>t</sub> = 100 mA |  |
|   | Leakage current | Maximum  | I <sub>l</sub>  | 5μA  |  | 3μA       | V = 30V                 |  |

Note: \* The thin short type is only available for 5V DC.

# MA Motion Sensor (AMA1, AMBA1, 2, 3)

2) External triggering type (trigger conditions: trigger pulse width = 20μs and trigger synchronization = 5ms)

| Items   | Symbol                   | Thin short type<br>Note 1                |                       | Short type | Middle type                                | Long type  | Measured conditions |
|---|--------------------------|--|-----------------------|------------|--|------------|---------------------|
|   |                          | NPN<br>output<br>type                    | PNP<br>output<br>type |            |  |            |                     |
| Rated operating voltage   | Minimum                  | 5V DC type: 4.5V/Free-ranging type: 5.5V |                       |            |  |            |                     |
|   | Typical                  | —  |                       |            |  |            |                     |
|   | Maximum                  | 5V DC type: 5.5V/Free-ranging type: 27V  |                       |            |  |            |                     |
| Average current<br>consumption  | Without<br>trigger input | Output OFF                               | Minimum               | —          |  |            | Note 2: *b          |
|   |                          |  | Typical               | —          |  |            |                     |
|   |                          |  | Maximum               | —          |  |            |                     |
|   |                          | Output ON                                | Minimum               | —          |  |            |                     |
|   |                          |  | Typical               | 0.1m       | 5V DC type: 0.1mA/Free-ranging type: 1.0mA |            |                     |
|   |                          |  | Maximum               | 0.3m       | 5V DC type: 0.3mA/Free-ranging type: 1.8mA |            |                     |
|   | With trigger<br>input    | Output OFF                               | Minimum               | —          |  |            | Note 2: *a          |
|   |                          |  | Typical               | —          |  |            |                     |
|   |                          |  | Maximum               | —          |  |            |                     |
|   |                          | Output ON                                | Minimum               | —          |  |            |                     |
|   |                          |  | Typical               | 2.2mA      | 5V DC type: 2.2mA/Free-ranging type: 3.1mA |            |                     |
|   |                          |  | Maximum               | 6.2mA      | 5V DC type: 6.2mA/Free-ranging type: 7.2mA |            |                     |
| Measuring cycle (Trigger interval)  | Output OFF               | Minimum                                  | —                     |            |  | Note 2: *c |                     |
|   |                          | Typical                                  | —                     |            |  |            |                     |
|   |                          | Maximum                                  | —                     |            |  |            |                     |
|   | Output ON                | Minimum                                  | —                     |            |  |            |                     |
|   |                          | Typical                                  | 4.2mA                 | 6.2mA      | 5V DC type: 2.4mA/Free-ranging type: 3.3mA |            |                     |
|   |                          | Maximum                                  | 8.2mA                 | 12.5mA     | 5V DC type: 8.2mA/Free-ranging type: 9.3mA |            |                     |
| External trigger  | Pulse width              | Minimum                                  | 5ms/cycle             |            |  |            |                     |
|   |                          | Maximum                                  | 20μs                  |            |  |            |                     |
|   | Level                    | Maximum                                  | 1/2Tt                 |            |  |            |                     |
|   |                          | Minimum                                  | 0.8V                  |            |  |            |                     |
| Response performance:<br>time from trigger pulse fall to detection output | Maximum                  | 3V                                       |                       |            | Note 3                                     |            |                     |
|   | Minimum                  | 5ms                                      |                       |            |  |            |                     |
| Output characteristics  | Remain voltage           | Maximum                                  | Vr                    | 1 V DC     | 1.2 V DC                                   | 1 V        | I = 10 mA           |
|   | Leakage current          | Maximum                                  | Ii                    | 5μA        |  | 3μA        | V = 30 mA           |

Notes: 1. The thin short type is only available for 5V DC.  
2. The ratio between the 4 operating modes (\*a to \*d) depends on the external trigger period and detector time, and the current consumption corresponds with this varying ratio.

4. The output transistor is open collector. The output transistor is turned ON by the sensor detection status and turned OFF by its non-detection status.



3. A high level is established in the open state due to pull-up by the internal circuit. (Refer to the connector wiring diagram.)

Detection status:  
output transistor ON  
Non-detection status:  
output transistor OFF

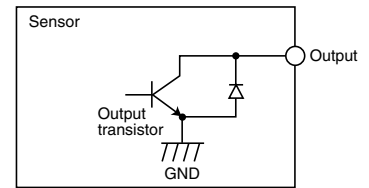

(NPN output types of the AMA series and all of AMBA series)

Detection status:  
output transistor ON  
Non-detection status:  
output transistor OFF

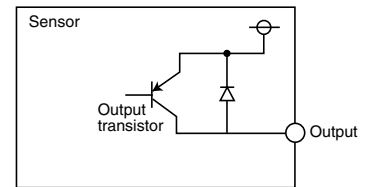

(PNP output types of the AMA series)

## TIMING CHART

### 1. Built-in oscillation circuit type



Notes: 1. Circuit stability time : Max. 12 ms  
2. During the time taken for the circuit to stabilize after the power is turned on, the ON/OFF status of the output transistor is not determined by whether the sensor is in the detection status or non-detection status.

## 2. External triggering type



Note: The sensor recognizes at the  $V_{TH} \rightarrow V_{TL}$  edge of an external trigger that the external trigger has been input.

- Notes: 1. Circuit stability time: Max. 12 ms  
2. During the time taken for the circuit to stabilize after the power is turned on, the ON/OFF status of the output transistor is not determined by whether the sensor is in the detection status or non-detection status.

## HOW TO USE

### 1. Wiring diagram of connector



- Notes: 1. The output transistor has an open collector structure.
- Detection status: Output transistor ON (connected to GND)
  - Non-detection status: Output transistor OFF (open state)
2. The status of the external trigger input is as follows:
- Open at the high level
  - GND (less than 0.8V) at the low level
- Under no circumstances must a high-level voltage be applied.
3. To maintain the power supply superimposed noise performance, be certain to connect a capacitor (33µF or more) to the sensor power supply input terminal in order to stabilize the power supply voltage.

# MA Motion Sensor (AMA1, AMBA1, 2, 3)

## REFERENCE DATA

### Operating region characteristics

• How to interpret the graph

Example: Operating area of the Short Type with rated detection distance of 8 cm 3.150 inch.



#### Operating area within the dotted lines

Objects that enter the entire area are detected.



Note: If only part of the object is in the detection area, it is not detected.

#### Operating area within the solid lines

Objects that even partially enter the area are detected.



### 1.-(1) Thin short type (AMA1□□□□□) Short type (AMBA1□□□□□)

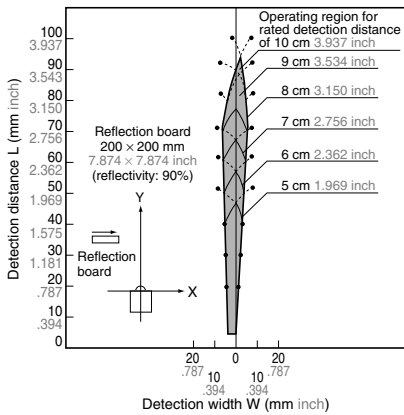

### 1.-(2) Middle type (AMBA2□□□□□)



### 1.-(3) Long type (AMBA3□□□□□)



## DIMENSIONS (mm inch)

The CAD data of the products with a **CAD Data** mark can be downloaded from: <http://industrial.panasonic.com/ac/e/>

(Common to the Built-in oscillation circuit type and External triggering type)

### 1. Thin short type (V type)

**CAD Data**

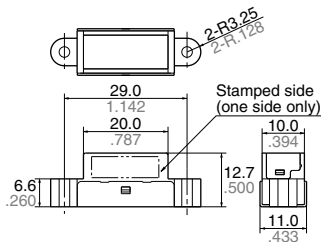

\*Rear side connector protrusion: Max. 0.4mm

### 2. Short type (H type)

**CAD Data**



### 3. Middle type (H type)

**CAD Data**





# MA Motion Sensor (AMA1, AMBA1, 2, 3)

## 4. Long type (H type)

**CAD Data**

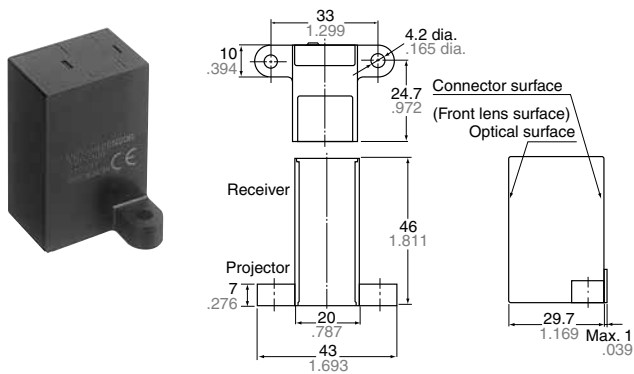

## 5. Long type (V type)

**CAD Data**

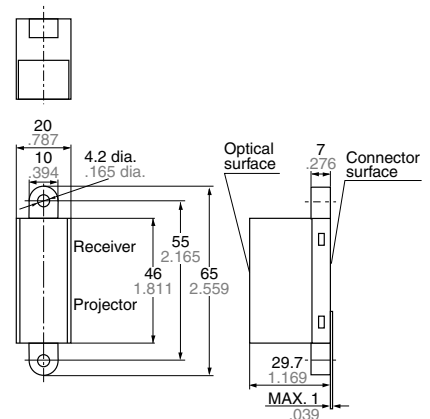

## WIRING DIAGRAM (Connector surface view)

### 1. Thin short type (V type)



### 2. Short type (H type)



### 3. Middle type (H type)

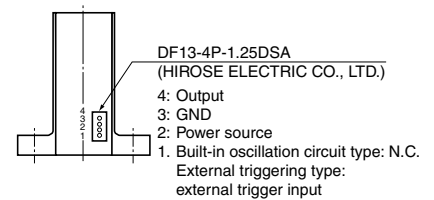

## 4. Long type (H type)

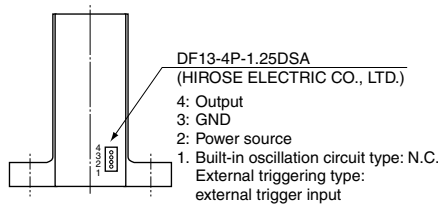

## 5. Long type (V type)

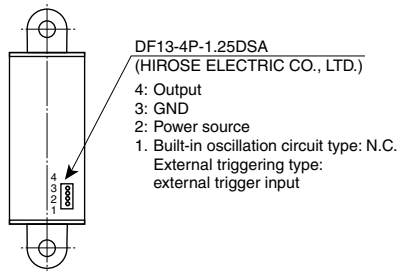

## OPTIONS (mm inch)

### 1. Connector with cable (for Short, Middle and Long type)

AMV9003

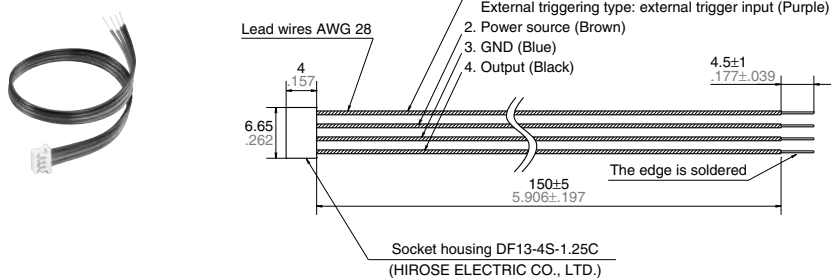

Note: Mistaken cable assembly can cause damage to the internal circuits, so please check the power cord before switching ON. (Particular care must be taken as to avoid reverse connection of the power.)

### 2. Connector with cable (for Thin short type)

AMV9002

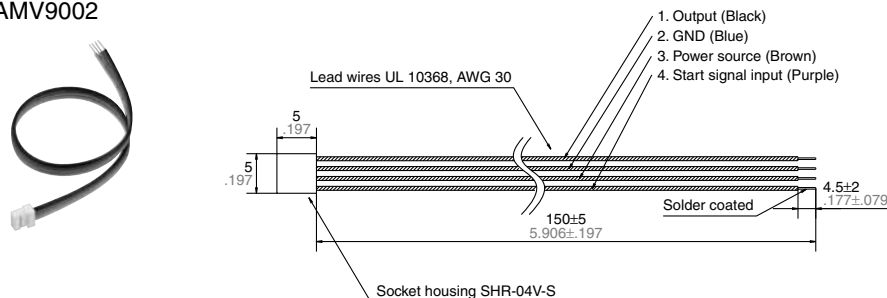

# MA Motion Sensor (AMA1, AMBA1, 2, 3)

## NOTES

### 1. Environment

- 1) Avoid using the sensor in environments containing excessive amounts of steam, dust, corrosive gas, or where organic solvents are present.
- 2) When the sensor is used in noisy environments, implement a countermeasure such as connecting a capacitor (Min. 33  $\mu$ F) across the power input terminals. Only use the sensor after verifying actual operation.

### 2. Wiring

- 1) Check all wiring before applying power. Incorrect wiring may damage the internal circuit (in particular, check that the connection to the power supply is not reversed.)
- 2) Avoid excessive removing and replacing of the connector.

### 3. Detector surface (Optical surface)

- 1) Keep the detector surface clean. Excessive dust or dirt on the detector surface will deteriorate the sensing performance.
- 2) Do not allow condensation or freezing to occur on the surface of the sensor. If condensation or freezing does occur at low temperatures, the sensor may not detect objects correctly.
- 3) This product is designed to detect the existence of human bodies. The sensor may not detect properly or the detection distance may become unstable if the objects consist of a low reflective material (e.g., an object coated with black rubber, etc.) or of a highly reflective material (e.g., mirror, glass, coated paper, etc.).

- 4) The front surface of the lens and case are made of polycarbonate resin and can withstand water, alcohol, oils, salts and weak acids. Other fluids such as alkalines, aromatic hydrocarbons and halogenated hydrocarbons may melt or swell the lens and case, please do not have such fluids touch the lens and case.
- 5) If you use the sensor with a cover or filter connected to the front of the sensor, the sensor may detect the cover itself, the detection distance can change, and unstable operation can result.
- 6) If this sensor is used in a position where it will be facing another sensor, light will be received from the other sensor which can cause mutual interference and malfunction. Therefore, please verify the installation conditions before use.

- 7) When multiple sensors are to be used side by side, please verify that there will be no mutual interference by installing them with the proper spacing, depending on the type as shown below.

| Model number | Sensor spacing   |
|--------------|------------------|
| AMBA1 series | 5 cm 1.969 inch  |
| AMA1 series  | 8 cm 3.150 inch  |
| AMBA2 series | 10 cm 3.937 inch |
| AMBA3 series | 20 cm 7.874 inch |

### 4. Recommended installation procedure

Install the sensor so that it is orientated correctly in relation to the pass directions of the target objects as shown in the figure below.

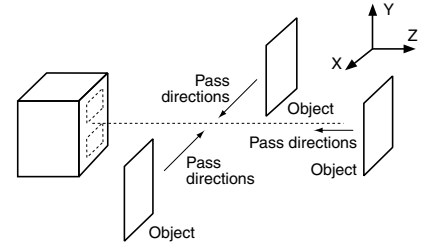

\* → stands for pass direction of the target object.

For the general precautions, refer to "NOTES FOR USING MOTION SENSOR (Common)" on next page.

单击下面可查看定价，库存，交付和生命周期等信息

[>>Panasonic\(松下\)](#)