

Notification about the transfer of the semiconductor business

The semiconductor business of Panasonic Corporation was transferred on September 1, 2020 to Nuvoton Technology Corporation (hereinafter referred to as "Nuvoton"). Accordingly, Panasonic Semiconductor Solutions Co., Ltd. became under the umbrella of the Nuvoton Group, with the new name of Nuvoton Technology Corporation Japan (hereinafter referred to as "NTCJ").

In accordance with this transfer, semiconductor products will be handled as NTCJ-made products after September 1, 2020. However, such products will be continuously sold through Panasonic Corporation.

Publisher of this Document is NTCJ.

If you would find description "Panasonic" or "Panasonic semiconductor solutions", please replace it with NTCJ.

※ Except below description page

"Request for your special attention and precautions in using the technical information and semiconductors described in this book"

Nuvoton Technology Corporation Japan

DATA SHEET

Part No.	MN63Y1210A
Package Code No.	SSOP016-P-0225E

Chapter 1 Overview

1

Chapter 2 Pin Descriptions

2

Chapter 3 Memory Map

3

Chapter 4 RF Communication Mode

4

Chapter 5 Serial Communication Mode

5

Chapter 6 Tunnel Mode

6

Chapter 7 Annex

7

Chapter 8 Electrical characteristics

8

Contents

Chapter 1 Overview	9
1.1 Features.....	10
1.2 Block Diagram.....	11
1.3 Operation Mode.....	12
Chapter 2 Pin Descriptions	15
2.1 List of Pins.....	16
2.2 Pin Descriptions.....	17
2.3 Connection Example.....	19
2.3.1 Using UART and 5 V Power.....	19
2.3.2 Using UART and 3 V Power.....	20
2.3.3 Using Clock Synchronous Mode and 5 V Power.....	21
2.3.4 Using Clock Synchronous Mode and 3 V Power.....	22
Chapter 3 Memory Map	23
3.1 Block Configuration	24
3.2 Physical Memory Map.....	25
3.3 System Area.....	26
3.3.1 Parameter Specifications	26
3.3.2 Enabling System Area	31
3.4 Address Correspondence	32
Chapter 4 RF Communication Mode	33
4.1 RF Communication Mode Sequence.....	34
4.2 JISX6319-4 Specification.....	35
4.2.1 Communication Specifications.....	35
4.2.2 Frame Format	35
4.2.3 State Transition Diagram.....	36
4.2.4 Flow Chart.....	36
4.2.5 Various Settings	37
4.2.5.1 System Code	37
4.2.5.2 PICC (Proximity IC Card) Identifier	37
4.2.5.3 Response Time Descriptor.....	37
4.2.5.4 Anticollision.....	38
4.2.5.5 Service.....	38
4.2.5.6 Block.....	39
4.2.5.7 Block List.....	40
4.2.5.8 Status Flag.....	42
4.2.6 Command	43
4.2.6.1 REQ.....	44

4.2.6.2 READ.....	45
4.2.6.3 WRITE.....	47
4.2.7 NDEF.....	49
4.2.7.1 MEMORY MAP.....	49
4.2.7.2 Setup of System Code (SC).....	50
4.2.7.3 Setup of Attribute Information Block.....	50
4.2.7.4 NDEF FILE.....	51
4.3 ISO/IEC14443 TypeB Specification.....	52
4.3.1 Communication Specification.....	52
4.3.2 Frame Format.....	52
4.3.3 Protocol Control.....	53
4.3.4 Block Control.....	54
4.3.5 Upper Command Format.....	55
4.3.6 State Transition Diagram.....	57
4.3.7 Flow Chart.....	58
4.3.8 Various Settings.....	59
4.3.8.1 AFI (Application Family Identifier).....	59
4.3.8.2 PUPI (Pseudo-Unique PICC Identifier).....	59
4.3.8.3 FWI (Frame Waiting Time Integer).....	59
4.3.8.4 File System.....	60
4.3.8.5 Address.....	60
4.3.8.6 Data.....	61
4.3.8.7 Status Word.....	61
4.3.9 Command.....	63
4.3.9.1 REQB/WUPB.....	64
4.3.9.2 ATTRIB.....	66
4.3.9.3 HLTB.....	68
4.3.9.4 SELECT.....	69
4.3.9.5 READ.....	70
4.3.9.6 WRITE.....	71

Chapter 5 Serial Communication Mode..... 73

5.1 Serial Communication Mode Sequence.....	74
5.2 UART.....	75
5.2.1 Communication Specifications.....	75
5.2.2 Frame Format.....	75
5.2.3 Specifying Data Rate.....	76
5.2.4 Specifying Response Wait Time.....	76
5.2.5 Status.....	76
5.2.6 Command.....	77
5.2.6.1 READ.....	78
5.2.6.2 WRITE.....	79
5.3 Clock Synchronous Serial Communication.....	80
5.3.1 Communication Specification.....	80
5.3.2 Frame Format.....	80
5.3.3 Time Chart.....	81
5.3.4 Status.....	81

5.3.5 Command	81
Chapter 6 Tunnel Mode	83
<hr/>	
6.1 Tunnel Mode Sequence	84
6.2 Communication between Reader/Writer and RFID	85
6.2.1 Using JISX6319-4	85
6.2.2 Using ISO/IEC14443	85
6.3 Communication between Host and RFID	86
6.3.1 Using UART	86
6.3.1.1 Communication Specification	86
6.3.1.2 IRQ Notification	86
6.3.2 Using Clock Synchronous Serial	88
6.3.2.1 Communication Specification	88
6.3.2.2 IRQ Notification	88
6.3.2.3 Configuring System Area (UARTSP Setting)	88
6.3.3 Response to QUERY Command	89
6.3.4 Timeout	89
6.3.4.1 Wait Time for QUERY Command	90
6.3.4.2 Wait Time for ANSWER Command	90
6.4 Command	92
6.4.1 Read in Tunnel Mode	93
6.4.2 Write in Tunnel Mode	96
Chapter 7 Annex	99
<hr/>	
7.1 Exclusive Control	100
7.2 State Transition Diagram in Operation Mode	103
7.3 Flow Chart in Tunnel Mode	104
7.4 Maximum Command Processing Time (UART)	106
Chapter 8 Electrical characteristics	107
<hr/>	

Chapter 1 Overview

1.1 Features

The MN63Y1210A is an LSI for RFID (Radio Frequency Identification), which features the following:

- Built-in 4-Kbit FeRAM non-volatile memory with fast write and low power consumption.
- RF interface compliant with JISX6319-4 (212 kbps / 424 kbps) and ISO/IEC14443 TypeB (106 kbps / 212 kbps) of the 13.56-MHz contactless IC card standards.
- Serial interface compatible with both asynchronous UART (up to 38.4 kbps) and clock synchronous (up to 1 Mbps)
- Batteryless RF communication
- Three communication modes of RF, serial, and tunnel (Tunnel mode allows communications between reader/writer and host CPU via this LSI.)
- Supply voltage range: 1.8 V to 3.6 V or 4.5 V to 5.5 V (when 5V tolerant I/O and clamp function is turned ON)
- 5-V operation (5V tolerant I/O, VDD2 pin clamp circuit built-in)

1.2 Block Diagram

Figure 1-1 shows a block diagram.

This RFID provides RF interface for contactless communication with external reader/writer, serial interface for contact communication with external host, control logic for command processing and various controls, 2-kbit transmit/receive buffer for RF communication, and 4-kbit FeRAM non-volatile memory.

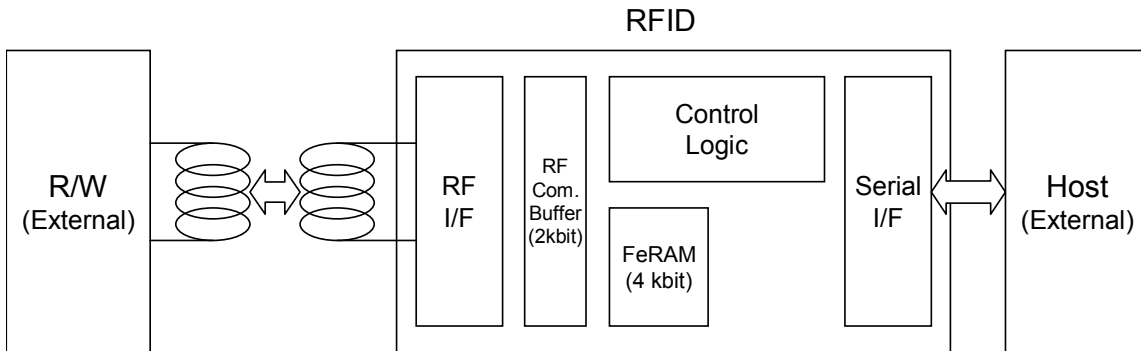

Figure 1-1 Block Diagram

1.3 Operation Mode

This RFID provides three operation modes of RF communication, serial communication, and tunnel.

Figure 1-2 gives the overview of each operation mode.

■ RF communication mode

This mode is used for communication between reader/writer and RFID. Reader/writer is the master and RFID is the slave. Key commands are read and write commands to FeRAM of RFID. This mode allows batteryless operations that use only the power supplied from the antenna of reader/writer.

For more information about RF communication mode, see Chapter 4 RF Communication Mode.

■ Serial communication mode

This mode is used for communication between host and RFID. Host is the master and RFID is the slave. Key commands are read and write commands to FeRAM of RFID. This mode requires a power supply to the supply voltage pin (VDD2) of RFID.

For more information about serial communication mode, see Chapter 5 Serial Communication Mode.

■ Tunnel mode

This mode is used for communication between reader/writer and host via RFID. Reader/writer is the master and host is the slave. Key commands are read and write commands to host. This mode requires a power supply to the supply voltage pin (VDD2) of RFID.

For more information about serial communication mode, see Chapter 6 Tunnel Mode.

Additionally, for state transition diagram in each operation mode, see Section 7.2 State Transition Diagram in Operation Mode.

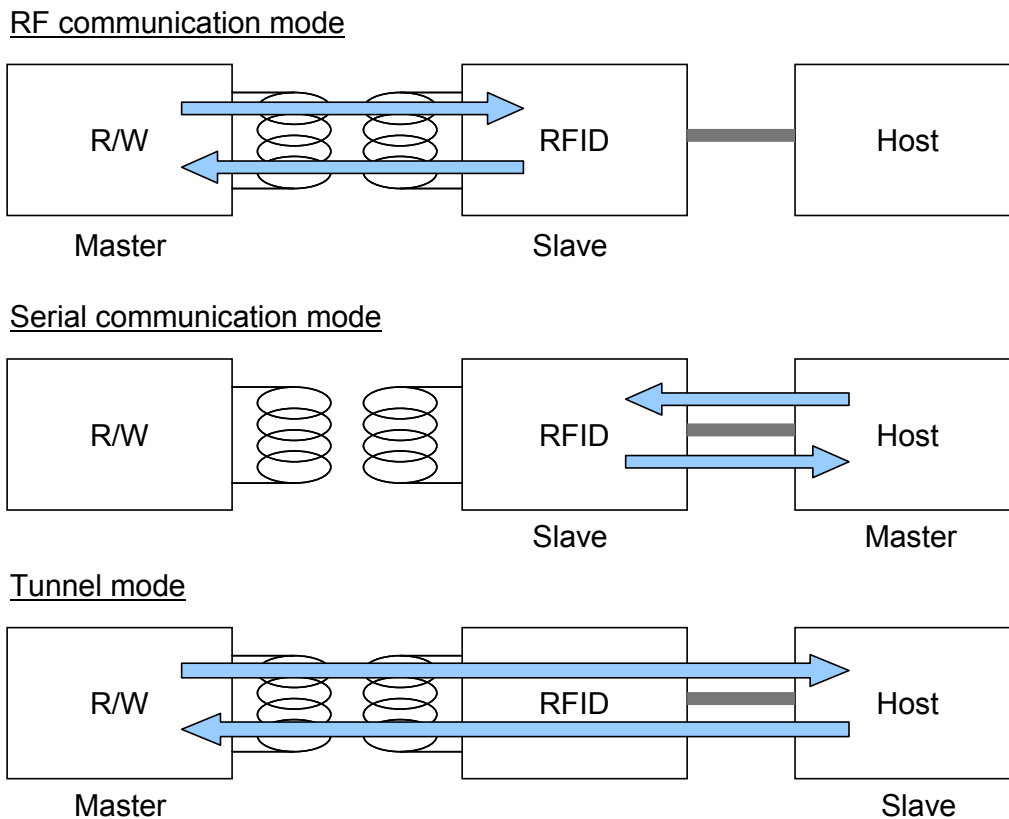

Figure 1-2 Operation Mode

Chapter 2 Pin Descriptions

2.1 List of Pins

Table 2-1 shows a list of pins of this RFID and Figure 2-1 illustrates the pin assignments of this RFID.

Table 2-1 List of Pins

Pin No.	Name	I/O	5V tolerant	Output type	Description
1	NC	-	-	-	Not connected
2	VB	I/O	-	-	Connected to coil
3	VDD2	-	-	-	Serial interface power supply
4	VDD	-	-	-	Internal digital power supply
5	VSS	-	-	-	Ground
6	VDD1	-	-	-	Internal analog power supply
7	VA	I/O	-	-	Connected to coil
8	NC	-	-	-	Not connected
9	TEST	Input	No	-	Test control
10	NCLP	-	No	-	Clamp control
11	RX	Input	Yes	-	Data reception (UART: RX, Clock sync: SCK)
12	TX3V	I/O	No	Open Drain	Data reception for 3 V (UART: TX, Clock sync: I/O)
13	TX5V	I/O	Yes	Open Drain	Data reception for 5 V (UART: TX, Clock sync: I/O)
14	IRQ3V	Output	No	Open Drain	Interrupt request output for 3 V
15	IRQ5V	Output	Yes	Open Drain	Interrupt request output for 5 V
16	SEL	Input	No	-	Serial interface selection

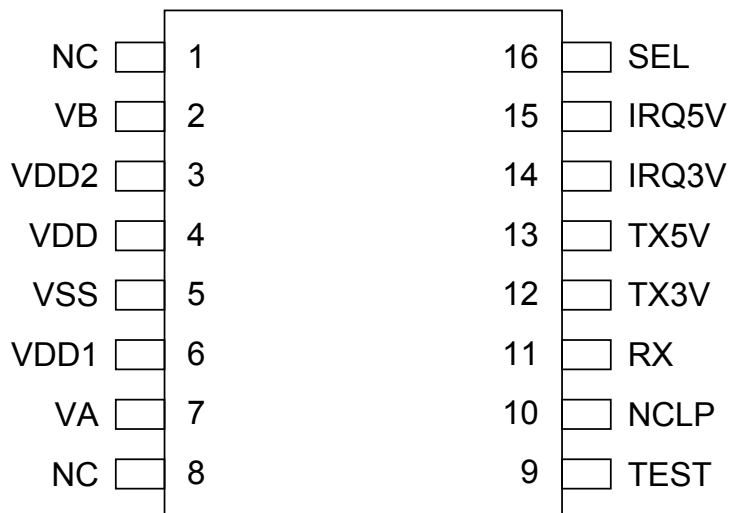

Figure 2-1 Pin Assignments (SSOP16)

2.2 Pin Descriptions

■ Coil connection pins (VA, VB)

Used for connecting an antenna coil. Also connect a resonance capacitor for adjusting resonance frequency.

■ Ground (VSS)

A reference power supply pin. Connect to the ground of the host CPU.

■ Internal analog power supply (VDD1)

An internal analog power supply pin. Connect a capacitor (see the Product Standards for its value) between VDD1 and VSS pins as close as possible to the RFID. It is unnecessary to apply an external power to this pin.

■ Internal digital power supply (VDD)

An internal digital power supply pin. Leave this pin open. Connect a capacitor (see the Product Standards for its value) between VDD and VSS pins as close as possible to the RFID. It is unnecessary to apply an external power to this pin.

■ Contact power supply VDD2

A contact power supply pin. Apply a high voltage to this pin when communicating data between the host CPU and RFID. Connect a capacitor (see the Product Standards for its value) between VDD2 and VSS pins as close as possible to the RFID.

Additionally, the RFID has a built-in clamp circuit for 5-V operation. When using the circuit, apply a 5-V supply voltage to this pin through a given resistor (see the Product Standards for its value).

■ Serial interface select pin (SEL)

Used for selecting serial interfaces. Set the pin to low for UART, and to high for clock synchronous. This pin is 5-V tolerant I/O.

■ Data receive pin (RX) [UART: RX; Clock synchronous: SCK]

A data input pin. It is used as RX for UART, and as serial clock input SCK for clock synchronous. This pin is 5-V tolerant I/O.

■ Data transmission in 3-V operation (TX3V) [UART: TX; Clock synchronous: I/O]

A data output pin. It is used as TX for UART, and as data I/O for clock synchronous. This pin is open-drain, so should be pulled up. Additionally, this pin is provided for 3-V operation. When not using, leave it open.

■ Data transmission in 5-V operation (TX5V) [UART: TX; Clock synchronous: I/O]

A data output pin. It is used as TX for UART, and as data I/O for clock synchronous. This pin is open-drain, so should be pulled up. Additionally, this pin is provided for 5-V operation. When not using, leave it open.

■ Interrupt request in 3-V operation (IRQ3V)

An interrupt request output pin. Receiving a command in tunnel mode from external reader/writer generates a low interrupt request signal pulse on this pin. This pin is open-drain, so should be pulled up. Additionally, this pin is provided for 3-V operation. When not using, leave it open.

■ Interrupt request in 5-V operation (IRQ5V)

An interrupt request output pin. Receiving a command in tunnel mode from external reader/writer generates a low interrupt request signal pulse on this pin. This pin is open-drain, so should be pulled up. Additionally, this pin is provided for 5-V operation. When not using, leave it open.

■ Test control (TEST)

Used in the test mode. Set it to low.

■ Clamp control (NCLP)

This pin controls ON/OFF of the clamp circuit connected to the VDD2 pin. Set it to high (OFF) in 3-V

operation. Set it to low (ON) in 5-V operation.

2.3 Connection Example

Several connection examples are shown below.

2.3.1 Using UART and 5 V Power

Figure 2-2 gives an connection example of using UART and 5-V power.

Set SEL to low in UART operation, and set NCLP to low in 5-V operation. With a series resistor connected (see the Product Standards for its value), apply a 5-V supply voltage to VDD2.

This example shows that the host's GPIO controls the RFID's VDD2. In this case, when not using serial communication, turning VDD2 off allows the consumption current of the RFID to be turned off. In addition, it is also possible to supply a voltage to VDD2 directly from the power supply, not from the host's GPIO.

Furthermore, when the host can always receive data from the RFID's TX, an interrupt request (IRQ) is reported from the TX as well, so allowing to omit IRQ connection.

The TX5V and IRQ5V pins are open-drain output. Pull these pins up to the same voltage level as the power supply of the host.

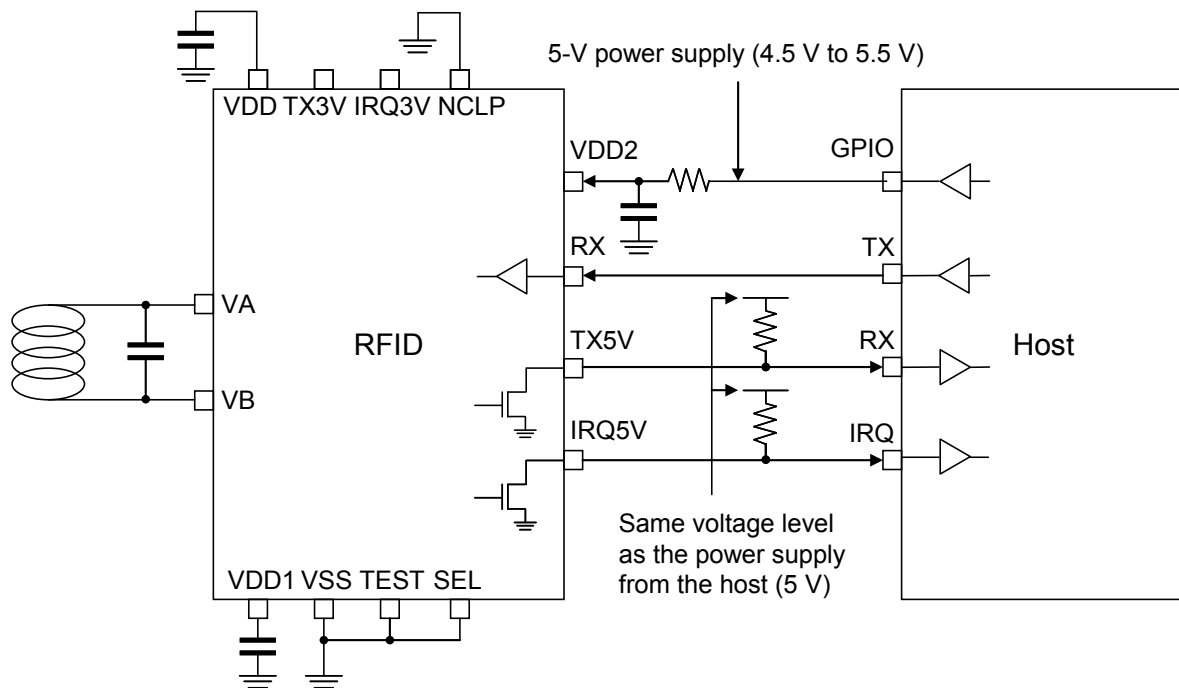

Figure 2-2 Connection Example of UART and 5 V Power Operation

2.3.2 Using UART and 3 V Power

Figure 2-3 gives an connection example of using UART and 3-V power.

Set SEL to low in UART operation, and set NCLP to high in 3-V operation.

This example shows that the host's GPIO controls the RFID's VDD2. In this case, when not using serial communication, turning VDD2 off allows the consumption current of the RFID to be turned off. In addition, it is also possible to supply a voltage to VDD2 directly from the power supply, not from the host's GPIO.

Furthermore, when the host can always receive data from the RFID's TX, an interrupt request (IRQ) is reported from the TX as well, so allowing to omit IRQ signal connection.

The TX3V and IRQ3V pins are open-drain output. Pull these pins up to the same voltage level as VDD2.

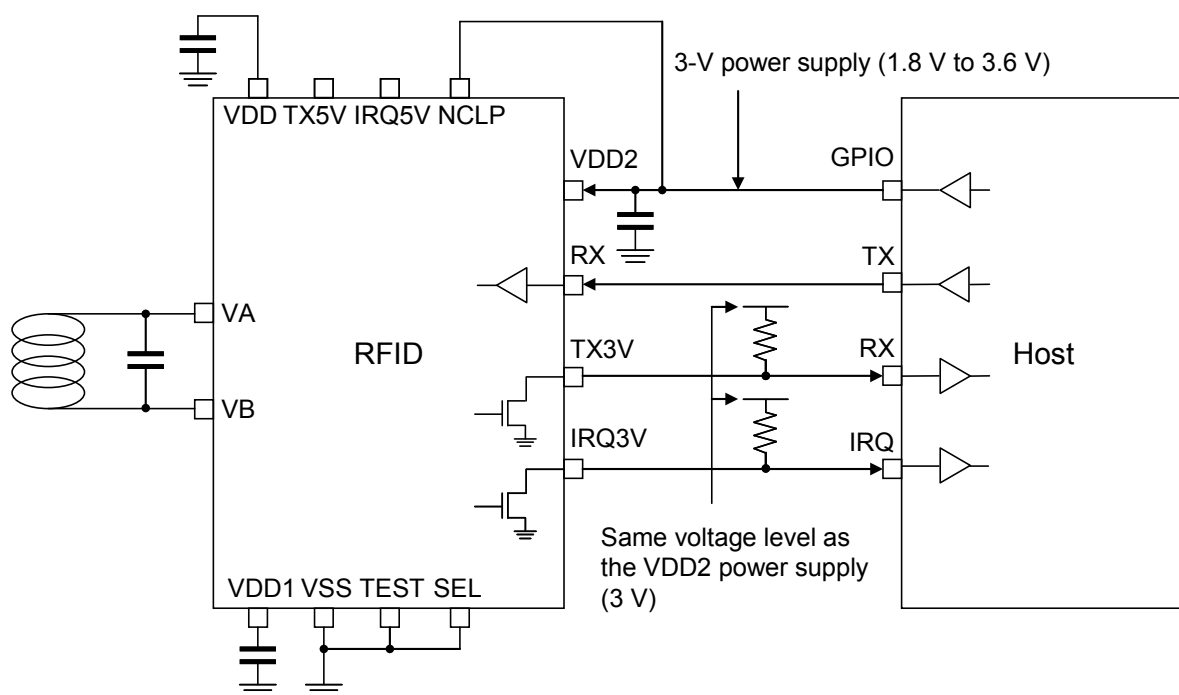

Figure 2-3 Connection Example of UART and 3 V Power Operation

2.3.3 Using Clock Synchronous Mode and 5 V Power

Figure 2-4 gives an connection example of using clock synchronous mode and 5-V power.

Set SEL to high in clock synchronous operation, and set NCLP to low in 5-V operation. With a series resistor connected (see the Product Standards for its value), apply a 5-V supply voltage to VDD2.

This example shows that the host's GPIO controls the RFID's VDD2. In this case, when not using serial communication, turning VDD2 off allows the consumption current of the RFID to be turned off. In addition, it is also possible to supply a voltage to VDD2 directly from the power supply, not from the host's GPIO.

The TX5V (I/O) and IRQ5V pins are open-drain output. Pull these pins up to the same voltage level as the power supply of the host.

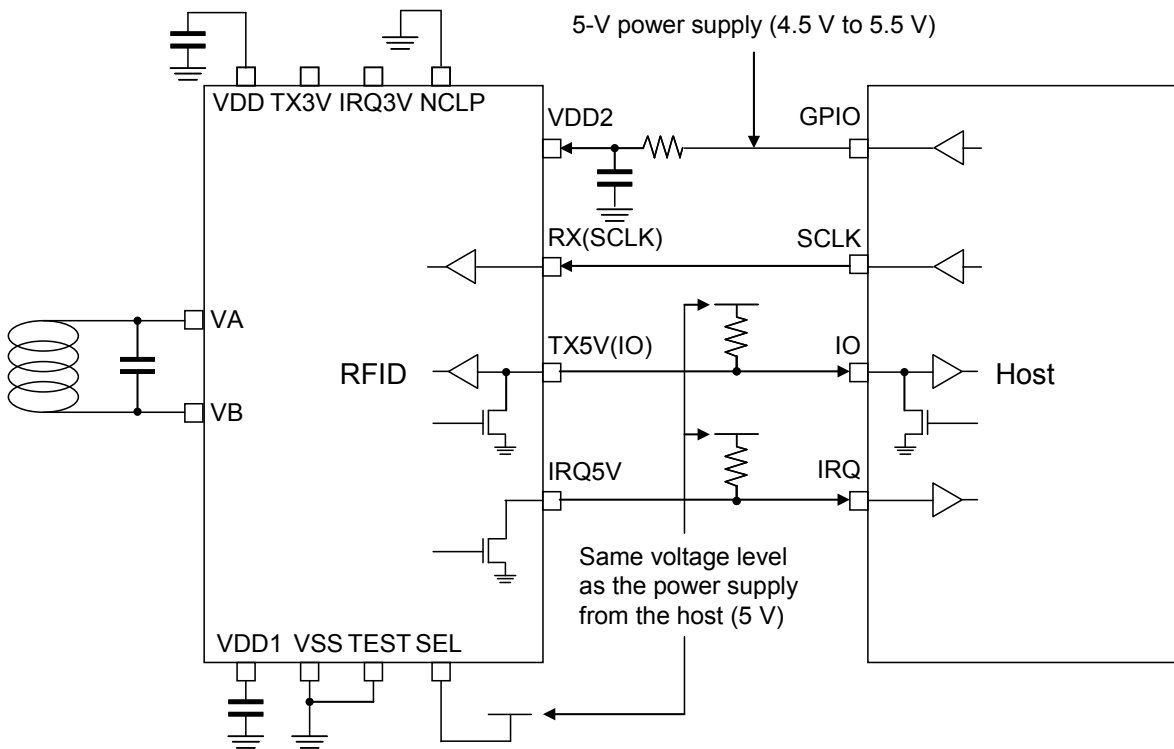

Figure 2-4 Connection Example of Clock Synchronous and 5 V Power Operation

Chapter 3 Memory Map

3.1 Block Configuration

Figure 3-1 illustrates the block configuration of 4-Kbit FeRAM.

This LSI consists of 32 FeRAM blocks. The size of a block is 16 bytes.

The memory consists of two areas: user and system areas.

The system area stores RF-communication-related parameters and memory-access-control-related data, etc.

Block	Area	Type
0	16Bytes FeRAM	User area
1	16Bytes FeRAM	
2	16Bytes FeRAM	
3	16Bytes FeRAM	
...	...	
24	16Bytes FeRAM	
25	16Bytes FeRAM	
26	16Bytes FeRAM	
27	16Bytes FeRAM	System area
28	16Bytes FeRAM	
29	16Bytes FeRAM	
30	16Bytes FeRAM	
31	16Bytes FeRAM	

Figure 3-1 4-Kbit FeRAM Block Configuration

3.2 Physical Memory Map

Figure 3-2 presents the physical memory map.

Block	Address	0x0	0x1	0x2	0x3	0x4	0x5	0x6	0x7	0x8	0x9	0xA	0xB	0xC	0xD	0xE	0xF	
0	0x0000	User Area																
1	0x0010	User Area																
2	0x0020	User Area																
3	0x0030	User Area																
4	0x0040	User Area																
5	0x0050	User Area																
6	0x0060	User Area																
7	0x0070	User Area																
8	0x0080	User Area																
9	0x0090	User Area																
10	0x00A0	User Area																
11	0x00B0	User Area																
12	0x00C0	User Area																
13	0x00D0	User Area																
14	0x00E0	User Area																
15	0x00F0	User Area																
16	0x0100	User Area																
17	0x0110	User Area																
18	0x0120	User Area																
19	0x0130	User Area																
20	0x0140	User Area																
21	0x0150	User Area																
22	0x0160	User Area																
23	0x0170	User Area																
24	0x0180	User Area																
25	0x0190	User Area																
26	0x01A0	User Area																
27	0x01B0	CONFIG																
28	0x01C0	CONFIG																
29	0x01D0	CONFIG																
30	0x01E0	SC	IDM						PMM	AFI	FWI	HW						
31	0x01F0	RORF				ROSI				SECURITY				TNPRM	CONFIG			

Figure 3-2 Physical Memory Map

3.3 System Area

This section describes the system area.

3.3.1 Parameter Specifications

Each parameter of the system area is shown below.

All addresses and block numbers used in this section correspond to the physical address in Figure 3-2.

■ RORF (4 bytes)

RORF is an area to specify whether read/write or read-only is to be used in accessing the block by memory access commands in RF communication mode. Table 3-1 describes RORF setting, and Table 3-2 shows RORF setting bits and corresponding block numbers. By default, all values are 0. Set all reserved bits to 0.

Table 3-1 RORF Setting

Value	Meaning
0	Read/Write
1	Read Only

Table 3-2 RORF Setting Bits and Corresponding Block Numbers

Address	Bit 7	Bit 6	Bit 5	Bit 4	Bit 3	Bit 2	Bit 1	Bit 0
0x01F0	Block7	Block6	Block5	Block4	Block3	Block2	Block1	Block0
0x01F1	Block15	Block14	Block13	Block12	Block11	Block10	Block9	Block8
0x01F2	Block23	Block22	Block21	Block20	Block19	Block18	Block17	Block16
0x01F3	Reserved	Reserved	Reserved	Reserved	Reserved	Block26	Block25	Block24

■ ROSI (4 bytes)

ROSI is an area to specify whether read/write or read-only is to be used in accessing the block by memory access commands in serial communication mode. Table 3-3 describes ROSI setting, and Table 3-4 shows ROSI setting bits and corresponding block numbers. By default, all values are 0. Set all reserved bits to 0.

Table 3-3 ROSI Setting

Value	Meaning
0	Read/Write
1	Read only

Table 3-4 ROSI Setting Bits and Corresponding Block Numbers

Address	Bit 7	Bit 6	Bit 5	Bit 4	Bit 3	Bit 2	Bit 1	Bit 0
0x01F4	Block7	Block6	Block5	Block4	Block3	Block2	Block1	Block0
0x01F5	Block15	Block14	Block13	Block12	Block11	Block10	Block9	Block8
0x01F6	Block23	Block22	Block21	Block20	Block19	Block18	Block17	Block16
0x01F7	Reserved	Reserved	Reserved	Reserved	Reserved	Block26	Block25	Block24

■ SECURITY (4 bytes)

SECURITY is reserved area for future use. By default, all values are 0. Set all bits to 0.

Table 3-5 SECURITY Setting Bit and Corresponding Block Number

Address	Bit 7	Bit 6	Bit 5	Bit 4	Bit 3	Bit 2	Bit 1	Bit 0
0x01F8	Reserved	Reserved	Reserved	Reserved	Reserved	Reserved	Reserved	Reserved
0x01F9	Reserved	Reserved	Reserved	Reserved	Reserved	Reserved	Reserved	Reserved
0x01FA	Reserved	Reserved	Reserved	Reserved	Reserved	Reserved	Reserved	Reserved
0x01FB	Reserved	Reserved	Reserved	Reserved	Reserved	Reserved	Reserved	Reserved

■ HW (2 bytes)

HW is an area to store various setting data related to the hardware of this RFID.

Table 3-6 describes the HW parameter. For the setting of the UART data rate UARTSP, see Table 3-7. For the setting of the RF communication protocol RFTYPE, Table 3-8. For the setting of IDM data selection IDMSSEL, see Table 3-9. For the setting of the IRQ output setting IRQSEL, see Table 3-10.

Table 3-6 HW Parameter

Address	Bit 7	Bit 6	Bit 5	Bit 4	Bit 3	Bit 2	Bit 1	Bit 0
0x01EE	UARTSP			RFTYPE		IDMSSEL	IRQSEL	Reserved
0x01EF	UARTWT							

Table 3-7 UARTSP Setting for Specifying UART Data Rate

Bit 7	Bit 6	bit 5	Meaning
0	0	0	UART data rate: 1200 bps
0	0	1	UART data rate: 2400 bps
0	1	0	UART data rate: 4800 bps
0	1	1	UART data rate: 9600 bps (default)
1	0	0	UART data rate: 19200 bps
1	0	1	UART data rate: 38400 bps
1	1	0	Reserved (When this field is specified, a default setting is applied.)
1	1	1	Clock synchronous serial

Note: When using a clock synchronous serial interface, set UARTSP (bits 7-5) to 111. For more information, see Section 6.3.2.3 Configuring System Area (UARTSP Setting).

Table 3-8 RFTYPE Setting for Selecting RF Communication Protocol

Bit 4	Bit 3	Meaning
0	0	Use both JISX6319-4 and ISO/IEC14443 TypeB. (Automatic protocol detection) (default)
0	1	Use JISX6319-4 only. (ISO/IEC14443 TypeB interface disabled)
1	0	Use ISO/IEC14443 TypeB only. (JISX6319-4 interface disabled)
1	1	Reserved (When this field is specified, a default setting will be applied.)

Table 3-9 IDMSSEL Setting for Selecting IDM Data

Bit 2	Meaning
0	Use the fixed values (All-0) as JISX6319-4 PICC identifier or ISO/IEC14443 TypeB PICC. Values written in the system area are not used. (default)
1	Use the values written in the system area as JISX6319-4 PICC identifier or ISO/IEC14443 TypeB PICC.

Table 3-10 IRQSEL Setting for Specifying IRQ Output

Bit 1	Meaning
0	Does not output IRQ notification code to TX when UART serial interface is used. (default)
1	Output IRQ notification code to TX when UART serial interface is used.

UARTWT specifies the minimum wait time until the RFID sends a response after it receives a command from the host while UART is used.

UARTWT is determined using the following formula.

$$\text{Minimum wait time} = T \times \text{UARTWT}$$

T: Typ. 128 μ s ($\pm 25\%$)

UARTWT: 0 to 255: (default: 100; Typ. approximately 12.8 ms)

Note: T includes an error of $\pm 25\%$. set the UARTWT value in consideration of the error.

Note: The minimum wait time might exceed the value specified in this setting, depending on the setting value of UARTWT and command processing.

■ TNPRM (2 bytes)

TNPRM is an area to store various setting data related to timeout.

For more information about this parameter, see Section 6.3.4 Timeout.

Table 3-11 describes the TNPRM parameter.

Table 3-11 TNPRM Parameter

Address	Bit 7	Bit 6	Bit 5	Bit 4	Bit 3	Bit 2	Bit 1	Bit 0
0x01FC	QWT				QRTRY		Reserved	Reserved
0x01FD	AWT				Reserved			

■ QWT

QWT specifies the maximum wait time until the RFID receives a QUERY command from the host after it sends an IRQ to the host during tunnel mode operation.

QWT is determined using the following formula.

$$\text{Maximum wait time for QUERY command} = T \times 2^{\text{QWT}}$$

T: Typ. 1024 μs (±25%)

QWT: 0 to 8 (default: 4; typ. approximately 16 ms)

When this field is set to a value other than 0 to 8, a default value will be applied.

■ QRTRY

QRTRY specifies the maximum number of retries to re-send IRQ when a timeout occurs for the maximum wait time for QUERY command while in tunnel mode operation. It ranges from 0 to 3, and its default value is 1.

When QRTRY is set to 0, the RFID responds with an error without re-sending IRQ.

■ AWT

AWT specifies the maximum wait time until the RFID receives an ANSWER command from the host after it sends a response to the QUERY command to the host during tunnel mode operation.

AWT is determined using the following formula.

$$\text{Maximum wait time for ANSWER command} = T \times 2^{\text{AWT}}$$

T: typ. 1024 μs (±25%)

AWT: 0 to 12 (default: 7; typ. approximately 131 ms)

When this field is set to a value other than 0 to 12, a default value will be applied.

Note: T includes an error of ±25%. set the QWT and AWT values in consideration of the error.

■ SC (2 bytes)

SC is used as the JISX6319-4 system code (2 bytes). For more information about system code, see 4.2.5.1 System Code.

Table 3-12 SC Parameter

Address	0x01E0	0x01E1
JISX6319-4 system code (2 bytes)	D0	D1
Default	0xAA	0xFF

■ IDM (8 bytes)

IDM is used as JISX6319-4 PICC (Proximity IC Card) identifier (8 bytes). The PUPI (Pseudo-Unique PICC Identifier) (4 bytes) of ISO/IEC14443 TypeB is shared with the lower 4 bytes of the JISX6319-4 PICC identifier. For information about JISX6319-4 PICC identifier, see Section 4.2.5.2 PICC (Proximity IC Card) Identifier, and for information about ISO/IEC14443 TypeB PUPI, see Section 4.3.8.2 PUPI.

Table 3-13 IDM Parameter

Address	0x01E2	0x01E3	0x01E4	0x01E5	0x01E6	0x1E7	0x1E8	0x01E9
JISX6319-4 PICC identifier (8 bytes)	D0	D1	D2	D3	D4	D5	D6	D7
Default	0x02	0xFE	0x00	0x00	0x00	0x00	0x00	0x00
ISO/IEC14443TypeB PUPI (4 bytes)	Reserved				D0	D1	D2	D3
Default	-	-	-	-	0x00	0x00	0x00	0x00

Note: In order to validate the value written in the system area IDM, the HW parameter's IDMSEL must be set to 1. See Table 3-9.

■ PMM (2 bytes)

Of the JISX6319-4 response time descriptor (8 bytes), PMM is an area (2 bytes) to specify maximum wait time for the response to READ/WRITE commands. See Section 4.2.5.3 Response Time Descriptor.

Table 3-14 PMM Parameter

Address	0x01EA	0x01EB
JISX6319-4 Response time descriptor (2 bytes)	D5	D6
Default	0xFF	0xFF

■ AFI (1 byte)

AFI is an area to specify AFI (Application Family Identifier) of ISO/IEC14443 TypeB. See Section 4.3.8.1 AFI.

Table 3-15 AFI Parameter

Address	0x01EC
ISO/IEC14443 TypeB AFI (1 byte)	D0
Default	0x00

■ FWI (1 byte)

FWI is an area to specify FWI (Frame Waiting time Integer) of ISO/IEC14443 TypeB. See Section 4.3.8.3 FWI.

Table 3-16 FWI Parameter

Address	0x01ED
ISO/IEC14443 TypeB FWI (1 byte)	D0
Default	0xE0

■ CONFIG

See the Administrator's Manual.

3.3.2 Enabling System Area

In order to enable parameters in the system area, CFEN (see the Administrator's Manual) of the system area must be set to a valid value. If CFEN is not set to a valid value, a default value defined by each parameter will be applied.

Table 3-17 lists the setting application timings after rewriting parameters in the system area while CFEN is enabled. New parameter setting is applied to RORF, ROSI, and SECURITY immediately after rewriting, and applied to other parameters after turning power supply ON from OFF.

Table 3-17 Parameter Application Timing

	A timing at which new parameter setting is applied after rewriting parameters when CFEN is enabled.
RORF	Apply immediately after rewrites.
ROSI	Apply immediately after rewrites.
SECURITY	Apply immediately after rewrites.
HW	Apply after turning power ON from OFF following rewrites.
TNPRM	Apply after turning power ON from OFF following rewrites.
SC	Apply after turning power ON from OFF following rewrites.
IDM	Apply after turning power ON from OFF following rewrites.
PMM	Apply after turning power ON from OFF following rewrites.
AFI	Apply after turning power ON from OFF following rewrites.
FWI	Apply after turning power ON from OFF following rewrites.
CONFIG	See the Administrator's Manual.

Note: Power OFF means power supplies from both VDD2 and RF interface are OFF.

3.4 Address Correspondence

Figure 3-3 presents the physical address and the corresponding address of each communication mode.

Physical address		Serial communication mode	RF communication mode		
			JISX6319-4		ISO/IEC14443
Block0	0x0000	0x0000	Block No. 0	D0	0x0000
	0x0001	0x0001		D1	0x0001
	0x0002	0x0002		D2	0x0002
	0x0003	0x0003		D3	0x0003
	0x0004	0x0004		D4	0x0004
	0x0005	0x0005		D5	0x0005
	0x0006	0x0006		D6	0x0006
	0x0007	0x0007		D7	0x0007
	0x0008	0x0008		D8	0x0008
	0x0009	0x0009		D9	0x0009
	0x000A	0x000A		Da	0x000A
	0x000B	0x000B		Db	0x000B
	0x000C	0x000C		Dc	0x000C
	0x000D	0x000D		Dd	0x000D
	0x000E	0x000E		De	0x000E
	0x000F	0x000F		Df	0x000F
Block1	0x0010	0x0010	Block No. 1	D0	0x0010
	0x0011	0x0011		D1	0x0011

	0x001E	0x001E		De	0x001E
	0x001F	0x001F		Df	0x001F
...					
Block31	0x01F0	0x01F0	Block No. 31	D0	0x01F0
	0x01F1	0x01F1		D1	0x01F1

	0x01FE	0x01FE		De	0x01FE
	0x01FF	0x01FF		Df	0x01FF

Figure 3-3 Address Correspondence

Chapter 4 RF Communication Mode

4.1 RF Communication Mode Sequence

Figure 4-1 illustrates the sequence in RF communication mode. Each sequence is described below.

SNo.1: A reader/writer sends an RF communication mode command to the RFID.

SNo.2: Once the RFID receives the RF communication mode command described in SNo.1, it processes the command and then sends the result to the reader/writer as the response to the command.

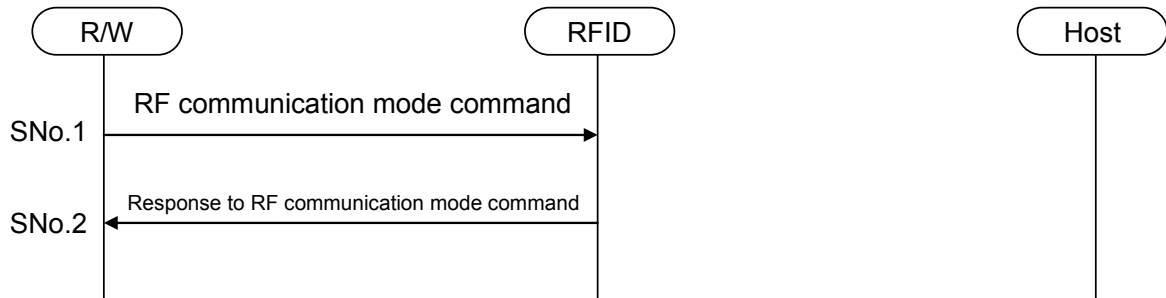

Figure 4-1 RF Communication Mode Sequence

4.2 JISX6319-4 Specification

This section describes the JISX6319-4 specification of this RFID.

4.2.1 Communication Specifications

Table 4-1 shows the JISX6319-4 specification of this RFID.

Table 4-1 JISX6319-4 Communication Specification

Carrier frequency		13.56 MHz
Modulation mode, Bit encoding	R/W→RFID	ASK10%, Manchester encoding
	RFID→R/W	Load modulation, Manchester encoding
Data rate		212 kbps / 424 kbps
Character transmission		<ul style="list-style-type: none"> · MSB-first · Data (8 bits) · No start bit · No parity bit · No stop bit · No spare time between characters

4.2.2 Frame Format

Figure 4-2 illustrates the JISX6319-4 frame format and Table 4-2 defines the fields.

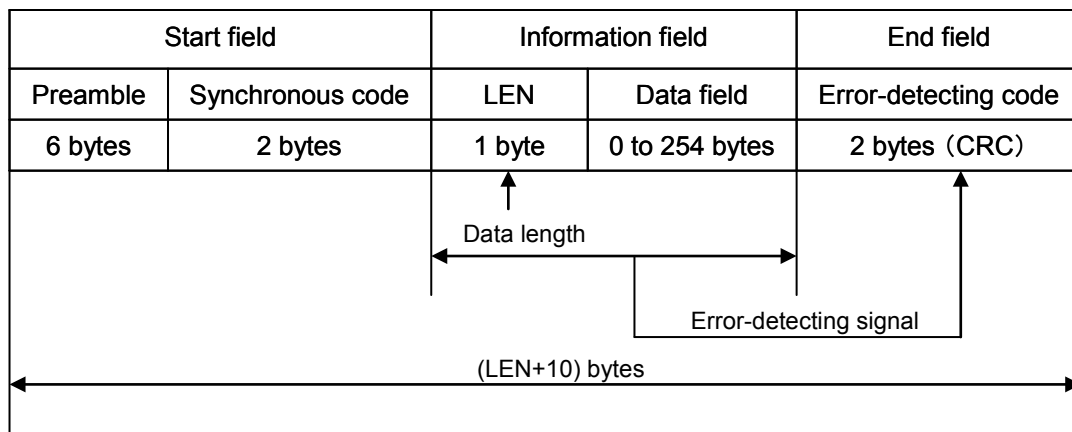

Figure 4-2 JISX6319-4 Frame Format

Table 4-2 JISX6319-4 Field Definition

Field name	Byte length	Definition
Preamble	6	0x000000000000
Synchronous code	2	0xB24D
LEN	1	n (data field length) + 1
Data field	n	Command message or Response message
Error-detecting code	2	Initial value: 0000, Generating polynomial: CRC of $X^{16}+X^{12}+X^5+1$

4.2.3 State Transition Diagram

Figure 4-3 shows the state transition diagram for the JIX6319-4 PICC of this RFID.

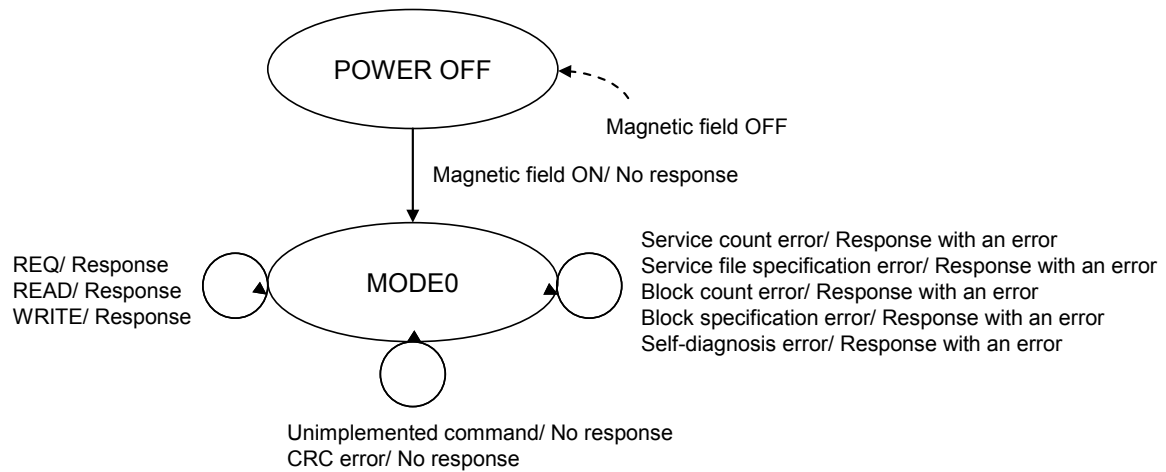

Figure 4-3 State Transition Diagram of JISX6319-4 PICC

4.2.4 Flow Chart

Figure 4-4 gives the flow chart for JIX6319-4 command processing of this RFID.

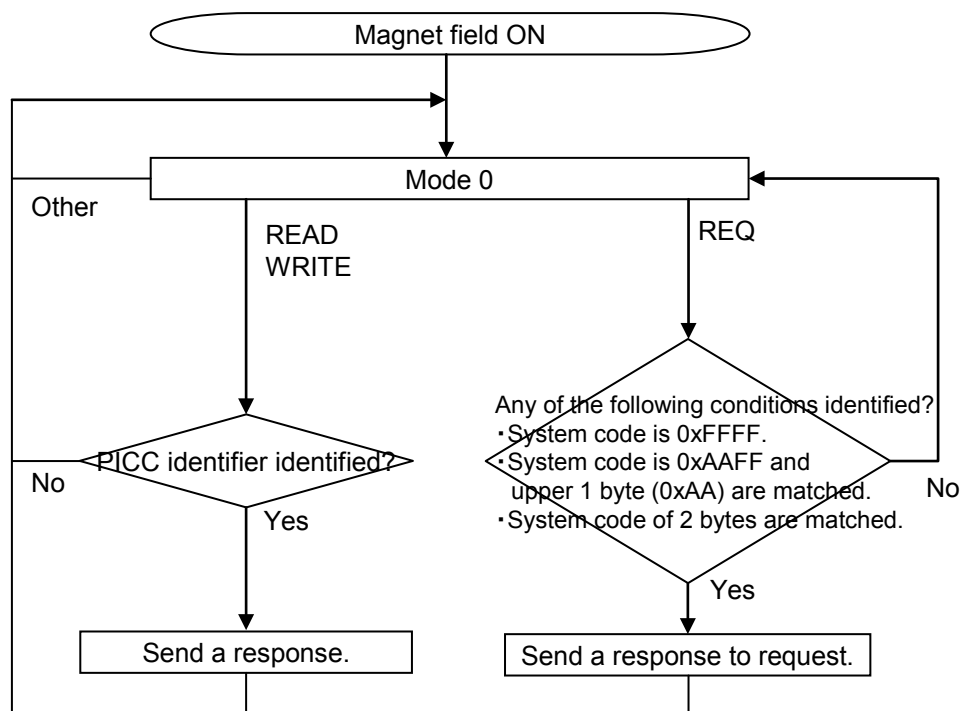

Figure 4-4 JISX6319-4 Flow Chart of Command Processing

4.2.5 Various Settings

This section describes the parameter settings and operation specifications based on JISX6319-4 for this RFID.

4.2.5.1 System Code

System code is a parameter specified by the REQ command that is used to identify the RFID. Figure 4-5 shows the system code. The system code is set by the value of the system area SC for FeRAM.

The response operation to the REQ command by system code is shown in Table 4-3.

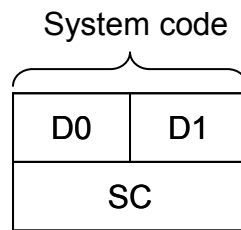

Figure 4-5 System Code

Table 4-3 Response to REQ Command by System Code

REQ command System code setting value	RFID's response to REQ command
0xFFFF	Responds regardless of the system area SC setting
0xA AFF	When the value of the upper 1 byte of the SC system area is 0xAA, the RFID responds regardless of the value of the lower 1 byte.
Other	Responds only when the setting value of the REQ command's system code matches the value specified in the system area SC (and does not respond in other cases).

4.2.5.2 PICC (Proximity IC Card) Identifier

The PICC (Proximity IC Card) identifier is a data used to identify RFID, and is included in the response to the REQ command. Figure 4-6 illustrates the PICC identifier's format. The PICC identifier (8 bytes) is set in the system area IDM.

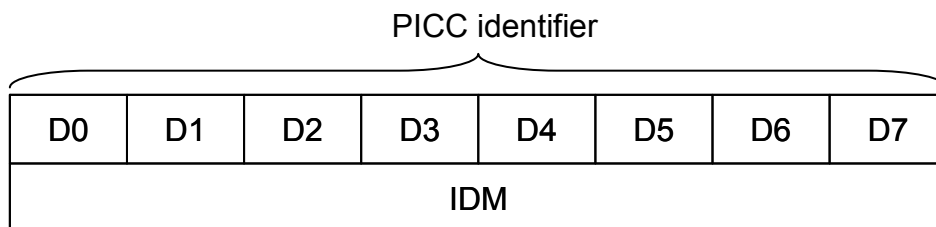

Figure 4-6 PICC Identifier Format

4.2.5.3 Response Time Descriptor

The response time descriptor is used to specify the maximum wait time until the RFID sends a response after reader/writer sends a command, and is included in the response to the REQ command. Figure 4-7 illustrates

the response time descriptor's format. In hardware, D0, D1, and D7 bytes are set to FFh and D2 to D4 bytes are set to 00h. The response time calculation parameters D5 and D6 bytes are the values of the system area. Table 4-4 shows the response time calculation parameter and corresponding command.

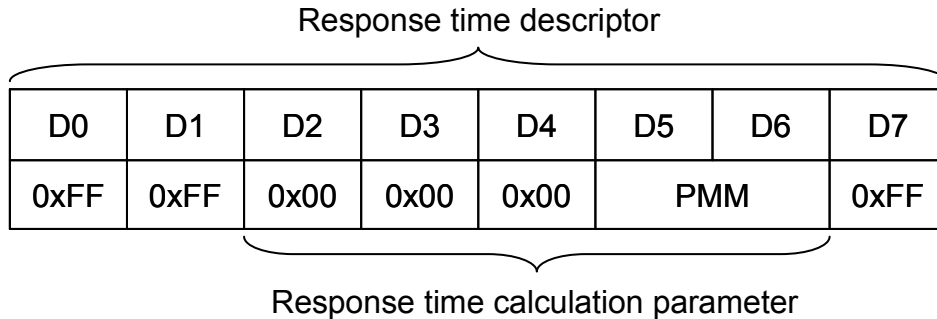

Figure 4-7 Response Time Descriptor Format

Table 4-4 Response Time Calculation Parameter and Corresponding Command

Response time calculation parameter	Command
D5	READ
D6	WRITE

Figure 4-8 shows the response time calculation parameter's format.

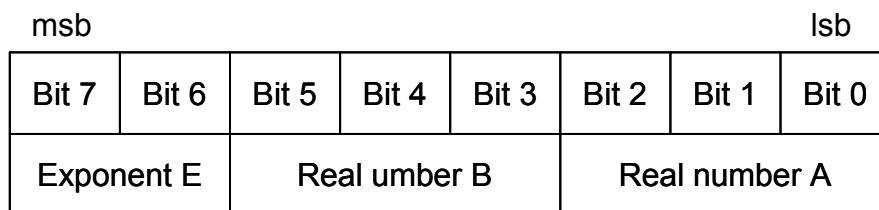

Figure 4-8 Response Time Calculation Parameter Format

The response time is calculated by the following formula:

$$\text{Response time} = T \times [(B + 1) \times n + (A + 1)] \times 4^E$$

T: $256 \times 16/f_c$ (approx. 0.302 ms)

n: No. of blocks or No. of files of command parameter.

4.2.5.4 Anticollision

JISX6319-4 uses the time slot method for anti-collision (prevention of collision). This RFID always responds according to the first slot.

4.2.5.5 Service

This RFID does not implement the concept of service based on JISX6319-4.

However, it is possible to specify multiple services using a command service list. Table 4-5 shows the available maximum number of services. When specifying multiple services in the service list, the values of service list must be set to the same value.

Table 4-5 Maximum Number of Services

Command	Maximum No. of services
READ	15
WRITE	11

Note: The RFID responds with an error when multiple services are not set to the same service file value.

4.2.5.6 Block

JISX6319-4 uses data of 16-byte blocks. Block number is used to specify each block. Figure 4-9 shows the block element of 2 bytes and Figure 4-10 shows the block element of 3 bytes. All of bits 6 to 4 of byte D0 for access mode setting should be set to 0 in this RFID; otherwise the RFID responds with an error.

		D0								D1							
		msb				lsb				msb				lsb			
		Bit 7	Bit 6	Bit 5	Bit 4	Bit 3	Bit 2	Bit 1	Bit 0	Bit 7	Bit 6	Bit 5	Bit 4	Bit 3	Bit 2	Bit 1	Bit 0
Definition	-	Access mode				Order of service code				Block number							
This RFID's setting value	1	0	0	0	Don't care				Block number designation								

Figure 4-9 Block Element of 2 Bytes

		D0								D1								D2							
		msb				lsb				msb				lsb				msb				lsb			
		Bit 7	Bit 6	Bit 5	Bit 4	Bit 3	Bit 2	Bit 1	Bit 0	Bit 7	Bit 6	Bit 5	Bit 4	Bit 3	Bit 2	Bit 1	Bit 0	Bit 7	Bit 6	Bit 5	Bit 4	Bit 3	Bit 2	Bit 1	Bit 0
Definition	-	Access mode				Order of service code				Block number															
This RFID's setting value	0	0	0	0	Don't care				Block number designation								0	0	0	0	0	Mode setting			

Figure 4-10 Block Element of 3 Bytes

This RFID uses a block number to specify tunnel mode and encrypted communication. Table 4-6 shows the mode settings for tunnel mode and encrypted communication. Bits 2 to 0 of byte D2 in 3-byte block element format are used. All of bits 7 to 3 of byte D2 should be set to 0; otherwise the RFID responds with an error.

Table 4-6 Mode Settings

Block element format	Byte D2 of block No.			Meaning
	Bit 2	Bit 1	Bit 0	Communication mode
2 bytes	-	-	-	RF communication mode
3 bytes	0	0	0	Reserved (Setting this field causes an error.)
	0	1	0	
	0	1	1	
	0	0	1	Tunnel mode
	1	0	0	
	1	1	0	
	1	1	1	
1	0	1	Reserved (Setting this field causes an error.)	

Table 4-7 shows the available maximum number of blocks. For READ command, the number is 13 in RF communication mode. The maximum number of blocks for WRITE command depends on the number of services.

Table 4-7 Maximum Number of Blocks

Command	Communication mode	No. of services	Maximum No. of blocks
READ	RF communication mode	1 to 15	13
	Tunnel mode	1 to 15	15
WRITE	RF communication mode, Tunnel mode	1 to 8	12
		9 to 11	11

4.2.5.7 Block List

For tunnel mode, how to specify block list is slightly different from the JISX6319-4 specification. Figure 4-11 shows the block list referenced from this RFID.

(1) RF communication mode: The block number of block list can be set freely. The RFID references to all block numbers.

(2) Tunnel mode: The block number of block list should be set in ascending order. The RFID checks that the block number is set in ascending order and if not, it responds with an error.

Note: When specifying multiple blocks, communication mode (RF communication mode/ tunnel mode) for all blocks should be configured to the same setting; if not, the RFID responds with an error.

Note: When setting block numbers in ascending order, set to 0x00 following the block number 0xFF (and set to 0x01 following 0x00). Mode setting (bits 2 to 0 of byte D2) for all blocks should be set to the same value.

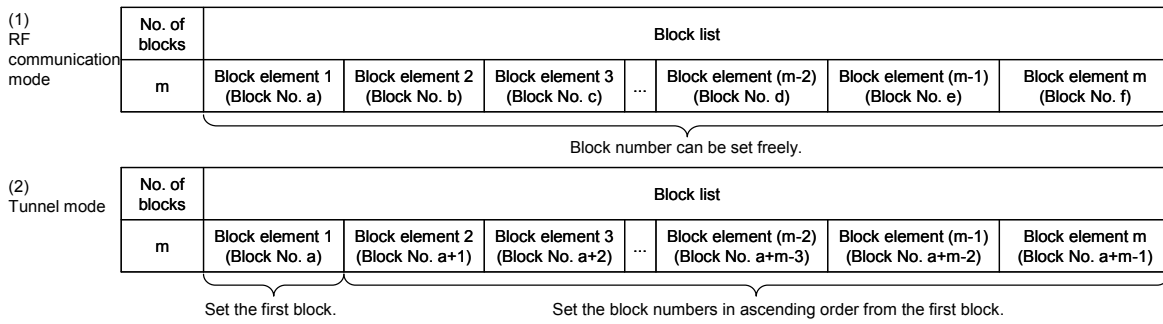

Figure 4-11 Block List Referenced from this RFID

Figure 4-12 shows the block data structure.
All block data are treated as actual data.

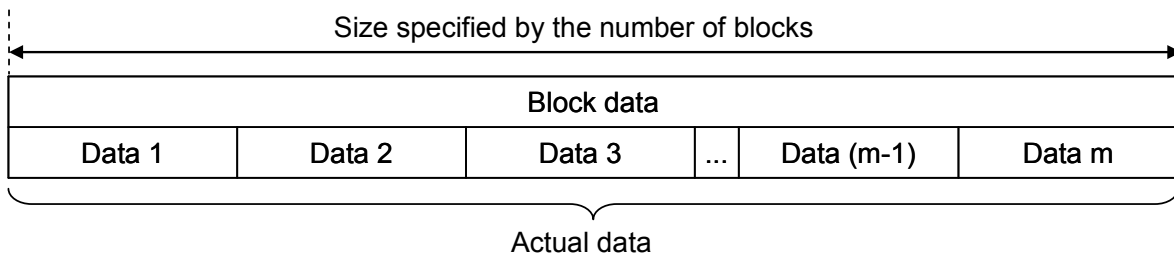

Figure 4-12 Block Data Structure

4.2.5.8 Status Flag

Table 4-8 lists the meanings of status flags.

Table 4-8 Status Flag

Status flag 1	Status flag 2	Meaning	Description
0x00	0x00	Normal end	Terminated normally.
0xFF	0x50	Tunnel mode error	No response from the host
0xFF	0x51	Tunnel mode error	The host responded with an error.
0xFF	0xA1	Service count specification error	The number of service files was out of the specification.
0xFF	0xA2	Block count specification error (*)	The number of blocks was out of the specification.
0xFF	0xA3	Service count specification error	Some settings for multiple service were different from the specification.
0xFF	0xA5	Block specification error	<ul style="list-style-type: none"> • Illegal access mode setting (except All-0) • Illegal mode setting (RFU setting) • Block number was specified outside FeRAM. • Ascending order was not used to specify block numbers in tunnel mode.
0xFF	0x60	Self-diagnosis error (*)	<ul style="list-style-type: none"> • Write access to FeRAM-Read-Only area (RORF setting)

(*) For more information about these errors, see the Administrator's Manual.

4.2.6 Command

Table 4-9 lists the JISX6319-4 commands supported by this RFID.

Subsequent sections describe each command in detail.

Table 4-9 JISX6319-4 Command List

Name	Code	Description
REQ	0x00	Reader/writer identifies RFID with this command.
READ	0x06	Reads data of RFID from reader/writer or, in tunnel mode, reads data of the host from reader/writer.
WRITE	0x08	Writes data to RFID from reader/writer or, in tunnel mode, writes data to the host from reader/writer.

4.2.6.1 REQ

■ Purpose

Reader/writer identifies RFID with this command.

■ Command message

● Format

Command code	System code	Request code	Timeslot
1 byte	2 bytes	1 byte	1 byte

● Data field

Field	Setting	Remarks
Command code	0x00	
System code	<ul style="list-style-type: none"> 0xFFFF: Identifies all RFIDs. 0xA AFF: Identifies RFID compliant with JISX6319-4, regardless of category. Other: The RFID corresponding to the specified system code responds. 	
Request code	<ul style="list-style-type: none"> 0x00: No request 0x01: Additional system code request 0x02: Additional transmission protocol capability request 	When values other than the values on the left column are set, the RFID treats this field as 0x00 (no request)
Timeslot	0x00: One slot	This RFID always treats this field as 0x00.

■ Response message

● Format

Response code	PICC identifier	Response time descriptor	Request data
1 byte	8 bytes	8 bytes	0 or 2 bytes

● Data field

Field	Output value	Remarks
Response code	0x01	
PICC identifier	See 4.2.5.2 PICC (Proximity IC Card) Identifier.	
Response time descriptor	See 4.2.5.3 Response Time Descriptor.	
Request data	<ul style="list-style-type: none"> Request code 0x00: Request data 0 bytes (No additional data) Request code 0x01: Adds system code. Request code 0x02: 0x0083 (212 kbps, 424 kbps, automatic data rate detection supported) 	

4.2.6.2 READ

■ Purpose

Reads data of RFID from reader/writer or, in tunnel mode, reads data of the host from reader/writer.

■ Command message

● Format

Command code	PICC identifier	No. of service file identifiers (k)	List of service file identifiers	No. of blocks (m)	Block list
1 byte	8 bytes	1 byte	2×k bytes	1 byte	2×m or 3×m bytes

● Data field

Field	Setting	Remarks
Command code	0x06	
PICC identifier	PICC identifier acquired by REQ command described in Section 4.2.6.1 REQ.	
No. of service file identifiers (k)	Number of service files Setting range: 0x01(1) to 0x0F(15)	When the range other than the range on the left column is set, the RFID responds with an error.
List of service file identifiers	Don't care (Setting example: 0x0900)	When specifying multiple services, the RFID responds with an error if all service files are not set to the same value.
No. of blocks (m)	Number of blocks specified in block list Setting range: · RF communication mode: 0x01(1) to 0x0D(13) · Other: 0x01(1) to 0x0F(15)	When the range other than the range on the left column is set, the RFID responds with an error.
Block list	Block list of data to be read For information about how to set, see the following: · 4.2.5.6 Block. · 4.2.5.7 Block List.	

■ Response message

● Format

Response code	PICC identifier	Status flag 1	Status flag 2	No. of blocks (m)	Block data
1 byte	8 bytes	1 byte	1 byte	1 byte	16×m byte

● Data field

Field	Output value	Remarks
Response code	0x07	
PICC identifier	See 4.2.5.2 PICC (Proximity IC Card) Identifier.	
Status flag 1	See 4.2.5.8 Status Flag.	

Status flag 2	See 4.2.5.8 Status Flag.	
No. of blocks (m)	Number of blocks specified by the command	Omitted when the status is not "Normal end"
Block data	See 4.2.5.7 Block List.	Omitted when the status is not "Normal end"

4.2.6.3 WRITE

■ Purpose

Writes data to RFID from reader/writer or, in tunnel mode, writes data to the host from reader/writer.

■ Command message

● Format

command code	PICC identifier	No. of service file identifiers (k)	List of service file identifiers	No. of blocks (m)	Block list	Block data
1 byte	8 bytes	1 byte	2×k bytes	1 byte	2×m or 3×m bytes	16×m bytes

● Data field

Field	Setting	Remarks
Command code	0x08	
PICC identifier	PICC identifier acquired by REQ command described in Section 4.2.6.1	
No. of service file identifiers (k)	Number of service files Setting range: 0x01(1) to 0x0B(11)	When the range other than the range on the left column is set, the RFID responds with an error.
List of service file identifiers	Don't care (Setting example: 0x0900)	When specifying multiple services, the RFID responds with an error if all service files are not set to the same value.
No. of blocks (m)	Number of blocks specified in block list Setting range: <ul style="list-style-type: none"> • No. of service files is 1 to 8: 0x01(1) to 0x0C(12) • No. of service files is 9 to 11: 0x01(1) to 0x0B(11) 	When the range other than the range on the left column is set, the RFID responds with an error.
Block list	Block list of data to be written For information about how to set, see the following: <ul style="list-style-type: none"> • 4.2.5.6 Block. • 4.2.5.7 Block List. 	
Block data	See 4.2.5.7 Block List.	

■ Response message

● Format

Response code	PICC identifier	Status flag 1	Status flag 2
1 byte	8 bytes	1 byte	1 byte

● Data field

Field	Output value	Remarks
Response code	0x09	
PICC identifier	See 4.2.5.2 PICC (Proximity IC Card) Identifier.	

Status flag 1	See 4.2.5.8 Status Flag.	
Status flag 2	See 4.2.5.8 Status Flag.	

4.2.7 NDEF

This RFID is based on Type3 Tag of NFC Forum and supports data exchange of a NDEF format. Data exchange of NDEF can be performed by performing a predetermined setup to the user area of FeRAM. Please refer to the applicable written standards of NFC Forum for the details of NDEF.

4.2.7.1 MEMORY MAP

The memory map at the time of NDEF use is shown in Fig. 4-13
 Attribute Information Block is arranged to Block0.
 NDEF file is arranged from Block1 to Block26.

Block	Address	0x0	0x1	0x2	0x3	0x4	0x5	0x6	0x7	0x8	0x9	0xA	0xB	0xC	0xD	0xE	0xF	
0	0x0000	Attribute Information Block																
1	0x0010	NDEF data area (message area)																
2	0x0020																	
3	0x0030																	
4	0x0040																	
5	0x0050																	
6	0x0060																	
7	0x0070																	
8	0x0080																	
9	0x0090																	
10	0x00A0																	
11	0x00B0																	
12	0x00C0																	
13	0x00D0																	
14	0x00E0																	
15	0x00F0																	
16	0x0100																	
17	0x0110																	
18	0x0120																	
19	0x0130																	
20	0x0140																	
21	0x0150																	
22	0x0160																	
23	0x0170																	
24	0x0180																	
25	0x0190																	
26	0x01A0																	
27	0x01B0	System Area																
28	0x01C0																	
29	0x01D0																	
30	0x01E0																	SC
31	0x01F0																	

Fig 4-13 The memory map at the time of NDEF use. (NFC Forum Type3 Tag)

4.2.7.2 Setup of System Code (SC)

In order to use NDEF of Type3 Tag, it is necessary to set value "0x12FC." on a system code (SC).

4.2.7.3 Setup of Attribute Information Block

Attribute Information Block(AIB) is arranged to Block0.

Explanation and the example of a setting of Attribute Information Block (AIB) are shown in Table 4-10.

Table 4-10 The example of a setting of Attribute Information Block (AIB)

Physical address	Size	Value	Contents	Supplement
0x0000	1Byte	0x10	Mapping Version	Please set up according to the NDEF standard version to apply.
0x0001	1Byte	0x0D	Nbr (The number of the maximum block of one read command)	Please set up 0x0F in this RFID.
0x0002	1Byte	0x0B	Nbw (The number of the maximum block of one write command)	Please set up 0x0B in this RFID.
0x0003 ~0x0004	2Byte	0x001A	Nmaxb (The number of maximum block of NDEF data which can handle this RFID)	
0x0005 ~0x0008	4Byte	0x00000000	Intact area	Please set 4 bytes of 0x00 to all.
0x0009	1Byte	0x00	WriteF 0x00 : Write-in completion 0x0F : Under a write-in advance	Please set "0x0F" before the writing of a NDEF message, and Please set "0x00" after all the writing of a NDEF message completed
0x000A	1Byte	0x01	RW-Flag 0x00 : AIB is read-only. 0x01 : Read and write are possible for AIB.	
0x000B ~0x000D	3Byte	0x000003	Ln (NDEF message length)	0x000003 = 3Byte (he value to a setting example of a setting of Talbe 4-11)
0x000E ~0x000F	2Byte	0x0046	CheckSum	The sum of data level to address 0x0000 - 0x000D

4.2.7.4 NDEF FILE

An empty NDEF file is shown in Table 4-11 as an example of a setting of a NDEF file.

Table 4-11 The example of a setting of a NDEF file (An empty NDEF file)

Physical address	Size	Value	Contents	Supplement
0x0010 ~0x0012	3Byte	0xD00000	NDEF Message	A mentioned value is a value which shows an empty message.

4.3 ISO/IEC14443 TypeB Specification

This section describes the ISO/IEC14443 TypeB specification.

4.3.1 Communication Specification

Table 4-12 provides the communication specifications of this RFID based on ISO/IEC14443 TypeB.

Table 4-12 ISO/IEC14443 TypeB Communication Specification

Carrier frequency		13.56 MHz
Moduration mode, Bit coding	R/W→RFID	ASK10%, NRZ coding
	RFID→R/W	Load modulation, BPSK coding (848 kHz subcarrier)
Data rate		106 kbps / 212 kbps
Character transmission		<ul style="list-style-type: none"> • LSB-first • Data (8 bits) • Start bit (1 bit) • Stop bit (1 bit)

4.3.2 Frame Format

Figure 4-14 illustrates the ISO/IEC14443 TypeB frame format. SOF(Start Of Frame) and EOF(End Of Frame) are added to a data field. The maximum size of data field is 256 bytes in this RFID.

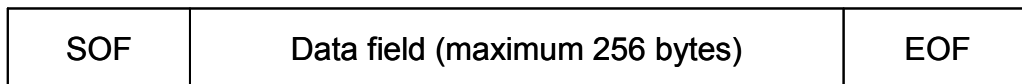

Figure 4-14 ISO/IEC14443 TypeB Frame Format

Additionally, the ISO/IEC14443-4 block format shown in Figure 4-15 is applied to the data field shown in Figure 4-14. This RFID does not support CID and NAD of the first field, so adding them is prohibited.

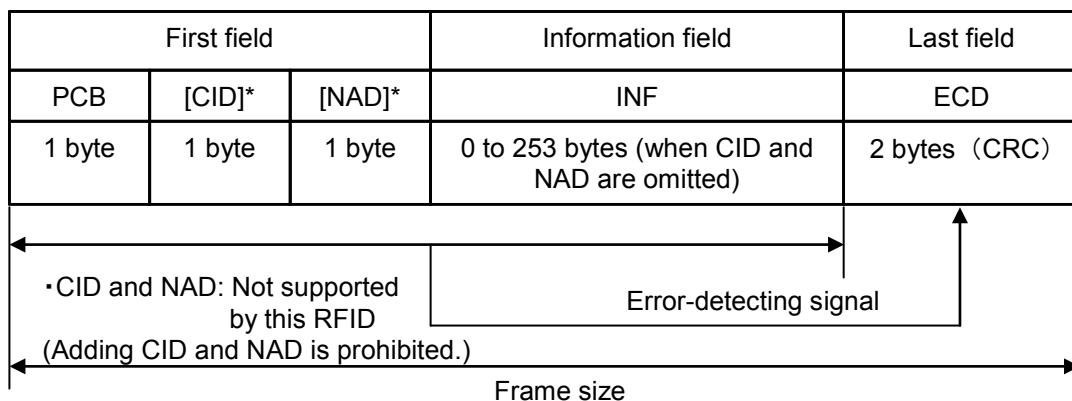

Figure 4-15 ISO/IEC14443-4 Block Format

Table 4-13 ISO/IEC14443-4 Field Definition

Field name	Byte length	Definition
PCB	1	Protocol Control Byte. See 4.3.3 Protocol Control.
CID	1	Card Identifier (optional) Used to identify RFID. (Not supported by this RFID; not added.)
NAD	1	Node Address (optional). Used to establish a logical channel. (Not supported by this RFID; not added.)
INF	n	Command message or response message
ECD	2	See CRC_B ISO/IEC14443-3.

4.3.3 Protocol Control

PCB (Protocol Control Byte) shown in Figure 4-15 and Table 4-13 is provided for ISO/IEC1443-4 protocol control, and used to send information necessary for data transmission control. This protocol has 3 block types. Table 4-14 lists the definition of block type. This RFID's protocol control specification is given in Table 4-15.

Figure 4-16, Figure 4-17, and Figure 4-18 illustrate I-block, R-block, and S-block codings, respectively.

Table 4-14 Block Type

Block name	Definition
I-block	Used to send the information of application layer.
R-block	Used to send ACK (Acknowledge) or NAK (NegativeAcknowledge). R-block does not include INF field. An R-block corresponding to the last reception block will be sent.
S-block	Used to send a control information. The following 2 types are provided: 1. Wait time extension request (WTX) 2. DESELECT command

Table 4-15 Protocol Control Specification

Item	Description	By this RFID
CID (Card Identifier)	First field parameter of ISO/IEC14443-4 frame (optional). Used to identify RFID.	Not supported
NAD (Node Address)	First field parameter of ISO/IEC14443-4 frame (optional). Used to establish a logical channel.	Not supported
Chaining	Used to transmit/receive divided data	Supported (however, the size of divisible frame size is 64 bytes or more.)
ACK/NCK response	Used to send ACK (Acknowledge) or NAK (NegativeAcknowledge).	Supported
WTX	Used to extend the wait time for response from RFID	Not supported
DESELECT command	Used to deselect the RFID.	Supported

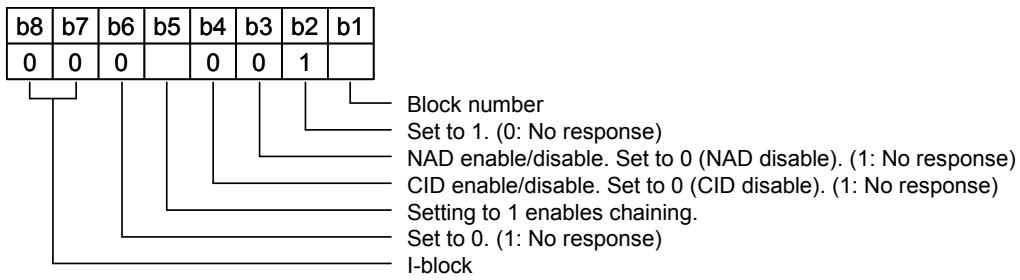

Figure 4-16 I-block Coding

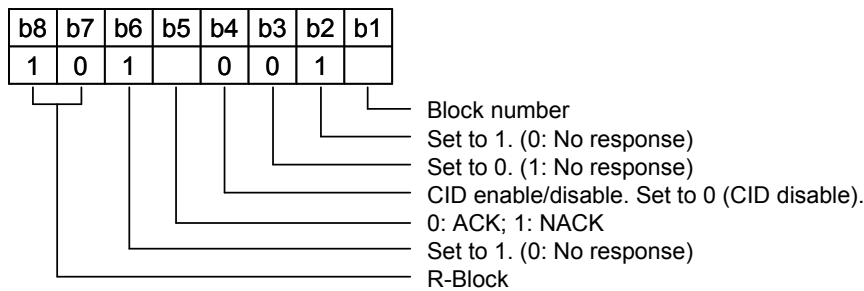

Figure 4-17 R-block Coding

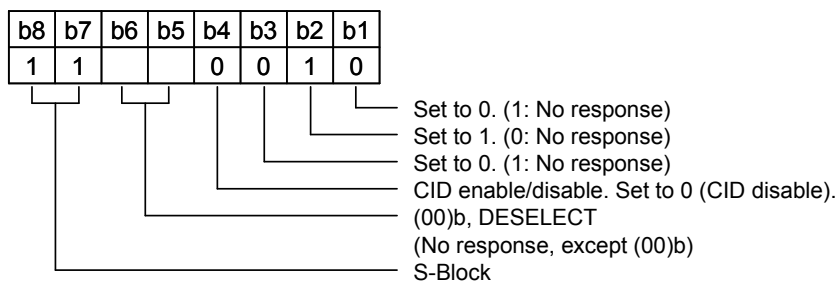

Figure 4-18 S-block Coding

4.3.4 Block Control

The block number rule for ISO/IEC1443-4 I-block is given in Table 4-16. The block control rule and whether to be supported by this RFID are shown in Table 4-17.

Table 4-16 Block Number Rule

Applied to	No.	Rule
Reader/ Writer	RuleA	Set the initial value of reader/writer block number to 0 whenever activating RFID.
	RuleB	When I-block or R(ACK) block whose block number is equal to the current one is received, toggle the current block number before sending the block number to RFID.
RFID	RuleC	Set the initial value of RFID block number to 1 whenever activating RFID.
	RuleD	When I-block is received, toggle the current block number before sending the block.
	RuleE	When R(ACK) block whose block number is not equal to the current one is received, RFID toggles the current block number before sending the block. When R(NAK) is received, do not toggle the block number.

Table 4-17 Block Control Rule

Applied to	No.	Rule	By this RFID
Reader/ Writer and RFID	Rule1	Send the first block from reader/writer.	Supported
	Rule2	When I-block indicating chaining is received, send an affirmative response to the block, with R(ACK) block.	Supported
	Rule3	S-block is used only for pair. Send a response to S(...)block whenever S(...)block is requested.	Only DESELECT supported
Reader/ Writer	Rule4	When an illegal block is received or FWT timeout occurs, send R(NAK) block (except while RFID is in chaining or when S(DESELECT) is executed).	-
	Rule5	When an illegal block is received or FWT timeout occurs while RFID is in chaining, send R(ACK) block.	-
	Rule6	When R(ACK) block is received and its block number is not equal to the block number of reader/writer, re-send the last I-block.	-
	Rule7	When R(ACK) block is received and its block number is equal to the block number of reader/writer, continue chaining.	-
	Rule8	When a response to S(DESELECT) is not sent with no error, re-send S(DESELECT) or ignore the RFID.	-
RFID	Rule9	RFID can send S(WTX) block, instead of I-block or R(ACK) block.	Not supported
	Rule10	When I-block not indicating chaining is not received, send an affirmative response.	Supported
	Rule11	When R(ACK) or R(NAK) block is received and its block number is equal to the block number of RFID, re-send the last I-block.	Supported
	Rule12	When R(NAK) block is received and its block number is not equal to the block number of RFID, send R(ACK).	Supported
	Rule13	When R(ACK) block is received and its block number is not equal to the block number of RFID and RFID is in chaining, continue chaining.	Supported

4.3.5 Upper Command Format

The upper commands (SELECT, READ, WRITE) are compliant with the APDU (Application Protocol Data Unit) format of ISO/IEC7816-4.

Figure 4-19 shows the command APDU format. Table 4-18 shows the command APDU field definition. Figure 4-20 gives the response APDU format. Table 4-19 gives the response APDU field definition.

The command APDU format shown in Figure 4-19 and the response APDU format shown in Figure 4-20 are configured in the information field INF of the ISO/IEC14443-4 block format shown in Figure 4-15.

CLA	INS	P1	P2	Lc	Data	Le
Class byte	Instruction byte	Param byte	Param byte	Lc field	Data byte (Lc bytes)	Le field

Figure 4-19 Command APDU Format

Table 4-18 Command APDU Field Definition

Field name	Byte length	Definition
Class byte	1	Fixed to 0x00
Instruction byte	1	Instruction code
Param byte 1	1	Command parameter
Param byte 2	1	Command parameter
Lc field	1	If a data byte exists in the command APDU, set the byte length of n; if not, omit the data byte.
Data byte	n	Data block (can be omitted)
Le field	1	If a data byte exists in the response APDU, set the byte length; if not, omit the data byte.

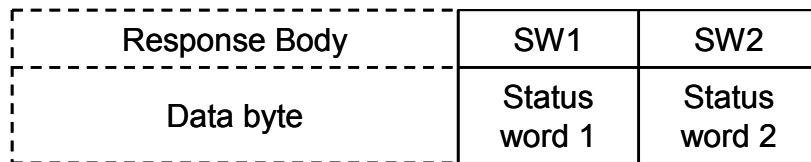

Figure 4-20 Response APDU Format

Table 4-19 Response APDU Field Definition

Field name	Byte length	Definition
Data byte	n	Data block (can be omitted)
Status word 1	1	Status information
Status word 2	1	Status information

4.3.6 State Transition Diagram

Figure 4-21 provides the state transition diagram for this RFID's operation based on ISO/IEC14443 TypeB.

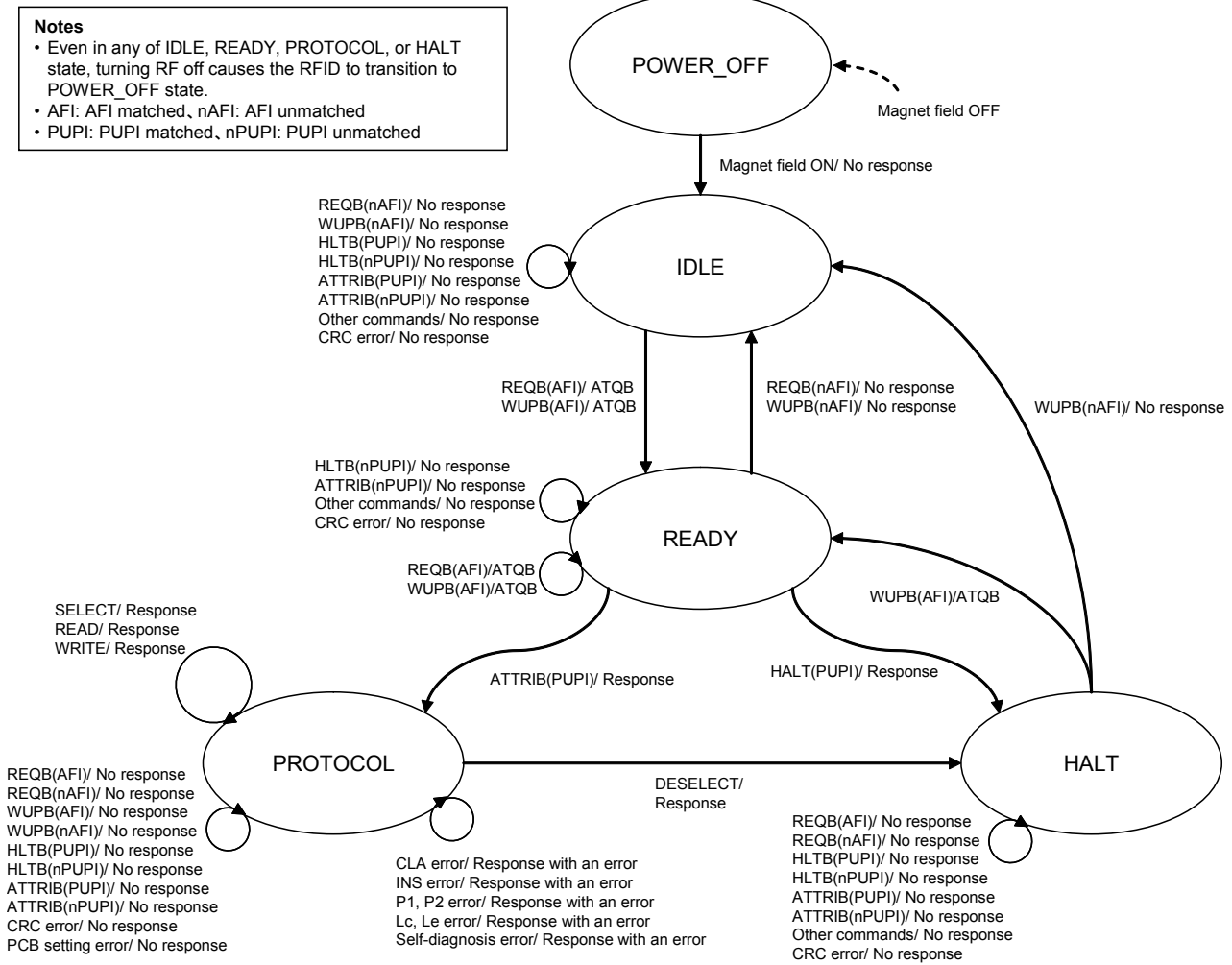

Figure 4-21 State Transtion Diagram for Operation Based on ISO/IEC14443 TypeB

4.3.7 Flow Chart

Figure 4-22 illustrates the flow chart for this RFID's command processing based on ISO/IEC14443 TypeB.

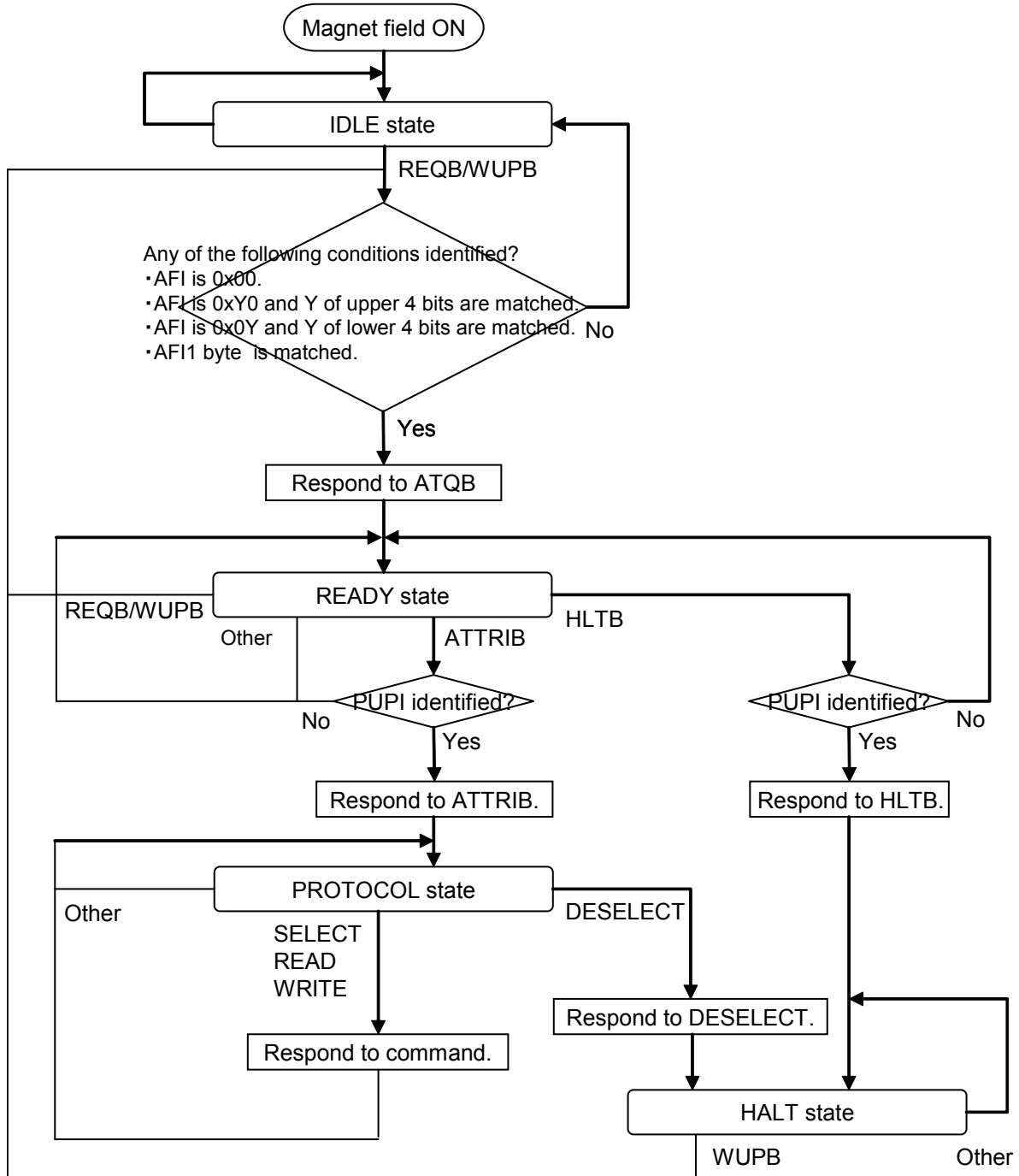

Figure 4-22 Flow Chart of Command Processing Based on ISO/IEC14443 TypeB

4.3.8 Various Settings

This section describes the parameter settings and operation specifications based on ISO/IEC14443 TypeB for this RFID.

4.3.8.1 AFI (Application Family Identifier)

Figure 4-23 shows the format of AFI (Application Family Identifier). The value of AFI is set in the system area AFI.

AFI is a parameter specified by the REQB command. The response operation to REQB command in this RFID is shown in Table 4-20. For information about the setting values for AFI, see ISO/IEC14443-3.



Figure 4-23 AFI Format

Table 4-20 REQB Command Response Operation

REQB command AFI setting value	RFID's response to REQB command
0x00	Responds regardless of the system area AFI setting.
0xY0	Responds when the value Y of the upper 4 bits of the REQB command's AFI is matched.
0x0Y	Responds when the value Y of the lower 4 bits of the REQB command's AFI is matched.
Other	Responds only when the setting value of the REQB command's AFI matches the value specified in the system area AFI.

4.3.8.2 PUPI (Pseudo-Unique PICC Identifier)

Figure 4-24 shows the format of PUPI (Pseudo-Unique PICC Identifier). PUPI is an identifier of PICC (Proximity IC Card). The value of PUPI is set in the lower 4 bytes of the system area IDM.

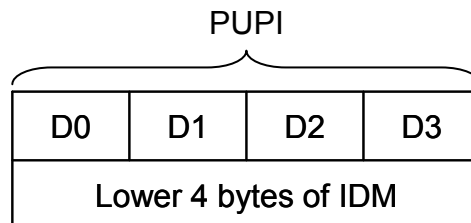

Figure 4-24 PUPI Format

4.3.8.3 FWI (Frame Waiting Time Integer)

Figure 4-25 shows the format of FWI (Frame Waiting time Integer). FWI is used to specify the maximum wait time until the PICC sends a response after receiving a command.

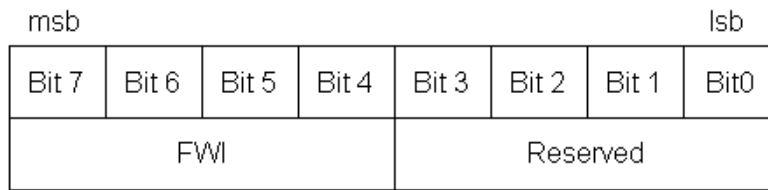

Figure 4-25 FWI Format

The maximum wait time is calculated by the following formula:

$$\text{Maximum wait time} = T \times 2^{\text{FWI}}$$

$$T: 256 \times 16/\text{fc} \text{ (fc = 13.56 MHz, approx. 0.302 ms)}$$

$$\text{FWI: 0 to 14 (integer)}$$

The maximum wait time ranges from approximately 0.302 ms (min.; FWI = 0) to approximately 4949 ms (max; FWI = 14).

4.3.8.4 File System

This RFID is compliant with the command specification of ISO/IEC7816-4 standards, but does not implement the file system functionality of the standards. However, in order to ensure the compatibility with communication to reader/writer, the SELECT command to select files is set to "Normal response" when specifying the given parameters. For information about how to set the parameters of the SELECT command, see 4.3.9.4 SELECT.

4.3.8.5 Address

In ISO/IEC14443 TypeB (command is compliant with ISO/IEC7816-4), the addresses of READ and WRITE commands are specified by bytes P1 and P2 of the command APDU. (See 4.3.5 Upper Command Format.)

Figure 4-26 shows the address specification format. Set bit 7 of byte P1 to 0; setting to 1 causes an error.

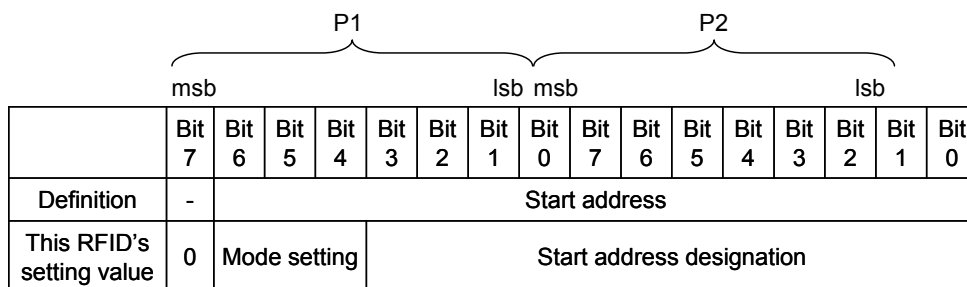

Figure 4-26 Address Specification

This RFID uses address to specify encrypted communication in tunnel mode. Table 4-21 shows mode settings including encrypted communication in tunnel mode with bits 6 to 4 of byte P1.

Table 4-21 Mode Settings

Byte P1			Meaning
Bit 6	Bit 5	Bit 4	Communication mode
0	0	0	RF communication mode
0	1	0	Reserved (Setting this field causes an error.)
0	1	1	
0	0	1	
1	0	0	Tunnel mode
1	1	0	Reserved (Setting this field causes an error.)
1	1	1	
1	0	1	

In addition, Table 4-22 shows the setting unit for address.

Table 4-22 Setting Unit for Address

Setting unit for address (n: integer)
1×n bytes

4.3.8.6 Data

The structure of data block for READ and WRITE commands is shown in Figure 4-27.

All block data are treated as actual data.

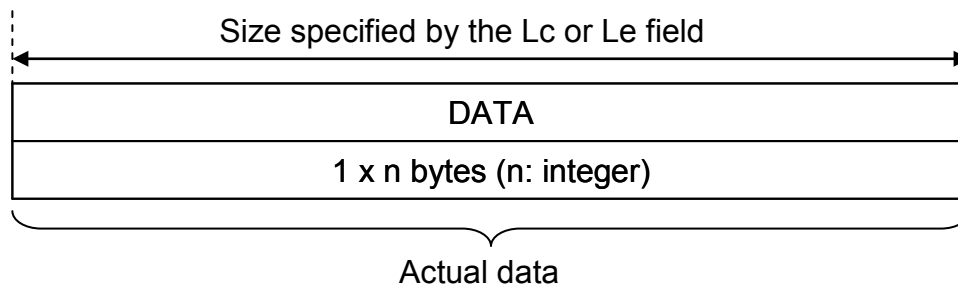

Figure 4-27 Data Block Structure

4.3.8.7 Status Word

Table 4-23 lists the meaning of statuses.

Table 4-23 Status Word

SW1	SW2	Meaning	Description
0x90	0x00	Normal end	Terminated normally.
0x50	0x00	Tunnel mode error	No response from the host
0x51	0x00	Tunnel mode error	The host responded with an error.
0x67	0x00	Lc/Le specification error (*)	• Lc and Le were out of the specification.
0x6A	0x86	P1-P2 specification error	• Bit 7 of P1 was not 0.

			<ul style="list-style-type: none">Illegal mode setting (RFU setting)Specified outside FeRAM
0x6D	0x00	INS specification error	Illegal INS setting (Specified an unimplemented command)
0x6E	0x00	CLA specification error	Illegal CLA setting (except 0x00)
0x6F	0x00	Self-diagnosis error (*)	<ul style="list-style-type: none">Write access to FeRAM-Read-Only area (RORF setting)

(*) For more information about these errors, see the Administrator's Manual.

4.3.9 Command

The commands based on ISO/IEC14443 TypeB supported by this RFID fall into two types:

Commands defined in ISO/IEC14443-3, and APDU commands defined in ISO/IEC7816-4 to be sent in the ISO/IEC14443-4 format.

These commands are shown in Table 4-24 and Table 4-25.

For information about the command format, see Section 4.3.2 Frame Format and Section 4.3.5 Upper Command Format.

Additionally, protocol control such as chaining, ACK/NAK response (R-Block), and DESELECT (S-Block) are also supported. For its detail, see Section 4.3.3 Protocol Control.

Subsequent sections describe each command in detail.

Table 4-24 ISO/IEC14443-3 TypeB Command List

Name	Code	Description
REQB/WUPB	0x05	Identifies the RFID. Used by reader/writer.
ATTRIB	0x1D	Exchanges protocol signal information between reader/writer and RFID, and causes the RFID to transition to the state in which command processing is enabled.
HLTB	0x50	Transitions the RFID to a HALT state. Used by reader/writer.

Table 4-25 APDU Command List

Name	INS	Description
SELECT	0xA4	Selects the file. (No processing is performed in this RFID.)
READ	0xB0	Reads the data of RFID from reader/writer. While in tunnel mode, reads the data of the host from reader/writer.
WRITE	0xD6	Writes a data to RFID from reader/writer. While in tunnel mode, writes a data to the host.

4.3.9.1 REQB/WUPB

■ Purpose

Identifies the RFID. Used by reader/writer

- REQB is used when the RFID is in IDLE state.
- WUPB is used when the RFID is in HALT state. (It can be also used in IDLE state.)

■ Command message

● Format

Command code	AFI	PARAM	CRC_B
1 byte	1 byte	1 byte	2 bytes

● Data field

Field	Setting	Remarks
Command code	0x05	
AFI	0x00: Identifies all RFIDs. 0xY0: RFID whose upper 4 bits are identified responds. 0x0Y: RFID whose lower 4 bits are identified responds. Other than 0x00: RFID corresponding to the specified system code responds.	See 4.3.8.1 AFI (Application Family Identifier).
PARAM	0x00: REQB 0x08: WUPB	This RFID always operates as follows: · Ignores the setting of bits 7-5. · Recognizes the number N of Slots is 1 (always responds with ATQB) even when bits 2-0 are set to any of the values (including PFU).
	Bits 7-5 RFU (Set to 000b.)	
	Bit 4 0: Extension ATQB not supported 1: Extension ATQB supported	
	Bit 3 0: REQB 1: WUPB	
	Bit 2-0 000b: Slot count N = 1 001b: Slot count N = 2 010b: Slot count N = 4 011b: Slot count N = 8 100b: Slot count N = 16 101b: RFU 110b: RFU	
CRC_B	See CRC_B ISO/IEC14443-3.	

■ Response message

● Format

Response code	PUPI	Application data	Protocol info	CRC_B
1 byte	4 bytes	4 bytes	3 bytes	2 bytes

● Data field

Field	Output value	Remarks	
response code	0x50 (ATQB)		
PUPI	See 4.2.5.2 PICC (Proximity IC Card) Identifier.		
Application Data	0x00000000	Reserved (treated as proprietary data.)	
Protocol Info	1st byte: 0x91	For more information about parameters, see ISO/IEC14443-3.	
	Bits 7-0		Data rate setting: 0x91 <ul style="list-style-type: none"> • R/W→RFID: 106K, 212K bps • RFID→R/W: 106K, 212K bps • R/W→RFID, RFID→R/W (same data rate)
	2nd byte: 0x81		
	Bits 7-4		Maximum frame size of RFID 1000b: 256 bytes
	Bits 3-0		Protocol type: 0001b <ul style="list-style-type: none"> • RFID is ISO/IEC14443-4 compliant • Minimum reader/writer command wait time (TR2) after RFID responds: 10etu + 32/fs (fs = 848 kHz)
	3rd byte: 0xX0 (X is a value of FWI.)		
	Bits 7-4		FWI (Frame Wating time Integer) See 4.3.8.3 FWI (Frame Waiting Time Integer).
	Bits 3-2		ADC (Application Data Coding) 00b: Proprietary Application Data
Bits 1-0	FO (Frame Option) 00b: NAD, CID not supported		
CRC_B	See CRC_B ISO/IEC14443-3.		

4.3.9.2 ATTRIB

■ Purpose

Exchanges protocol signal information between reader/writer and RFID, and causes the RFID to transition to the state in which command processing is enabled.

■ Command message

● Format

Command code	Identifier	Param1	Param2	Param3	Param4	CRC_B
1 byte	4 bytes	1 byte	1 byte	1 byte	1 byte	2 bytes

● Data field

Field	Setting	Remarks	
Command code	0x1D		
Identifier	Sets PUPI for ATQB response.		
Param1	0x00	This RFID operates with: • bits 1-0 ignored • bits 7-6 set to 00b (when these bits are set to 11b) • bits 5-4 set to 00b (when these bits are set to 11b) This RFID operates with: • Minimum TR0: 64/fs • Minimum TR1: 80/fs • EOF not omitted • SOF not omitted	
	Bits 7-6		Minimum value of RFID response time to reader/writer command (TR0): (fs = 848 kHz) 00b: 64/fs (106 Kbps), 64/fs (212 Kbps) 01b: 48/fs (106 Kbps), 32/fs (212 Kbps) 10b: 16/fs (106 Kbps), 8/fs (212 Kbps) 11b: RFU
	Bits 5-4		Minimum value of the time (TR1) until RFID starts data transmission after subcarrier is generated: (fs = 848 kHz) 00b: 80/fs (106 Kbps), 80/fs (212 Kbps) 01b: 64/fs (106 Kbps), 32/fs (212 Kbps) 10b: 16/fs (106 Kbps), 8/fs (212K bps) 11b: RFU
	Bit 3		0: Do not omit EOF. 1: Omit EOF.
	Bit 2		0: Do not omit SOF. 1: Omit SOF.
	Bits 1-0	RFU (Set to 00b.)	
Param2	0xXX (For XX, see the settings below.)	• If parameters other than those on the left (communication settings or reader/writer frame size which the RFID does not support) are set, the RFID will generate no response. • If the data rate setting differs between RFID→PCD and	
	Bits 7-6		RFID→PCD data rate 00b: 106 Kbps 01b: 212 Kbps
	Bits 5-4		PCD→PICC data rate 00b: 106 Kbps 01b: 212 Kbps
	Bits 3-0		Maximum receivable frame size of

		reader/writer 1000b: 256 bytes 0111b: 128 bytes 0110b: 96 bytes 0101b: 64 bytes	PCD→RFID, the RFID will generate no response.
Param3	0x01		If parameters other than those on the left are set, the RFID will generate no response.
	Bits 7-4	RFU (Set to 0000b.)	
	Bits 3-0	Set to the same value as that for the protocol type (4 bits) of the ATQB parameter's second byte.	
Param4	0x00		The RFID operates with: · bits 7-4 ignored · no response generated except when bits 3-0 are set to 0000b
	Bits 7-4	RFU (Set to 0000b.)	
	Bits 3-0	0000b: RFID does not support CID.	
CRC_B	See CRC_B ISO/IEC14443-3.		

■ Response message

● Format

Response code	CRC_B
1 byte	2 bytes

● Data field

Field	Output value	Remarks
response code	1st byte: 0x10	
	Bits 7-4	MBLI (Maximum Buffer Length Integer) 0001b: 1x of RFID frame size (256 bytes)
	Bits 3-0	0000b: RFID does not support CID.
CRC_B	See CRC_B ISO/IEC14443-3.	

4.3.9.3 HLTB

- Purpose

Causes the RFID to transition to a HALT state. Used by reader/writer.

- Command message

- Format

Command code	Identifier	CRC_B
1 byte	4 bytes	2 bytes

- Data field

Field	Setting	Remarks
Command code	0x50	
Identifier	Sets the PUPI of the RFID to be set to a HALT state.	
CRC_B	See CRC_B ISO/IEC14443-3.	

- Response message

- Format

Response code	CRC_B
1 byte	2 bytes

- Data field

Field	Output value	Remarks
Response code	0x00	
CRC_B	See CRC_B ISO/IEC14443-3.	

4.3.9.4 SELECT

■ Purpose

Selects the file.

This RFID responds normally when receiving this command, however, it performs no internal processing.

■ Command message

● Format

CLA	INS	P1	P2	Lc	Data
1 byte	1 byte	1 byte	1 byte	1 byte	2 bytes

● Data field

Field	Setting	Remarks
CLA	0x00	Responds with an error, except 0x00.
INS	0xA4	
P1	0x02: Selects EF file.	Responds with an error, except 0x02.
P2	0x0C: FCI generates no response.	Responds with an error, except 0x0C.
Lc	Sets the byte length of the Data block. setting range: 0x02(2)	Responds with an error, except the setting range on the left column.
Data	Don't care (This field is set by EF-ID.)	The RFID does not reference to this parameter.

■ Response message

● Format

SW1	SW2
1 byte	1 byte

● Data field

Field	Output value	Remarks
SW1	See 4.3.8.7 Status Word.	
SW2	See 4.3.8.7 Status Word.	

4.3.9.5 READ

■ Purpose

Reads the data of RFID from reader/writer. While in tunnel mode, reads the data of the host from reader/writer.

■ Command message

● Format

CLA	INS	P1	P2	Le
1 byte	1 byte	1 byte	1 byte	1 byte

● Data field

Field	Setting	Remarks
CLA	0x00	Responds with an error, except 0x00.
INS	0xB0	
P1	Sets the start address to be read. · See 4.3.8.5 Address.	
P2	Sets the start address to be read. · See 4.3.8.5 Address.	
Le	Sets the byte length of data to be read. · Setting range: 0x01(1) to 0xFB(251)	

■ Response message

● Format

Data	SW1	SW2
1 to 251 bytes	1 byte	1 byte

● Data field

Field	Output value	Remarks
Data	Sets the data to be read. · See 4.3.8.6 Data.	Omitted except when status word ends normally.
SW1	See 4.3.8.7 Status Word.	
SW2	See 4.3.8.7 Status Word.	

4.3.9.6 WRITE

■ Purpose

Writes a data to RFID from reader/writer. While in tunnel mode, writes a data to the host.

■ Command message

● Format

CLA	INS	P1	P2	Lc	Data
1 byte	1 byte	1 byte	1 byte	1 byte	1 to 248 bytes

● Data field

Field	Setting	Remarks
CLA	0x00	Responds with an error, except 0x00.
INS	0xD6	
P1	Sets the start address of data to be written. · 4.3.8.5 Address.	
P2	Sets the start address of data to be written. · 4.3.8.5 Address.	
Lc	Sets the byte length of the Data block. · Setting range: 0x01(1) to 0xF8(248)	
Data	Sets the data to be written. · 4.3.8.6 Data.	

■ Response message

● Format

SW1	SW2
1 byte	1 byte

● Data field

Field	Output value	Remarks
SW1	See 4.3.8.7 Status Word.	
SW2	See 4.3.8.7 Status Word.	

Chapter 5 Serial Communication Mode

5.1 Serial Communication Mode Sequence

Figure 5-1 illustrates the sequence in serial communication mode. Each sequence is described below.

SNo.1: The host sends a serial communication mode command to the RFID.

SNo.2: Once the RFID receives the serial communication mode command described in SNo.1, it processes the command and then sends the result to the host as the response to the command.

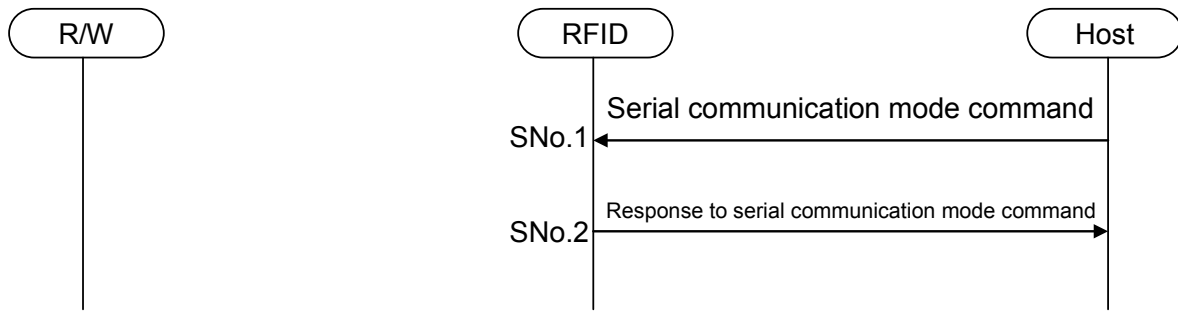

Figure 5-1 Serial Communication Mode Sequence

5.2 UART

This section describes the UART specification.

5.2.1 Communication Specifications

Table 5-1 shows the UART specification of this RFID.

Table 5-1 UART Communication Specification

Data transfer method	Asynchronous, half-duplex (Only IRQ notification allows full-duplex)
Data rate	1200 bps, 2400 bps, 4800 bps, 9600 bps, 19200 bps, 38400 bps
Character transmission	<ul style="list-style-type: none"> · LSB-first · Data (8 bits) · Start bit (1bit) · Parity bit (1bit, even) · Stop bit (1bit)
Other	No flow control signal (RTS/CTS)

5.2.2 Frame Format

Figure 5-2 illustrates the UART frame format, Table 5-2 defines the fields, and Table 5-3 lists the frame end conditions.

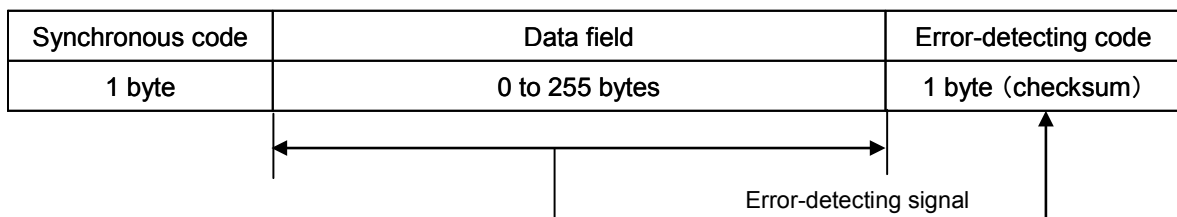

Figure 5-2 Frame Format

Table 5-2 Field Definition

Field name	Byte length	Definition
Synchronous code	1	0x66
Data field	n	Command message or Response message
Error-detecting code	1	2's complement of the sum of data field's data

Table 5-3 Frame End Conditions

Data rate	Frame end conditions
9600 bps or less	Frame reception terminates by receiving a checksum (Note) or by receiving no data for 10 ms or more.
More than 9600 bps	Frame reception terminates by receiving checksum (Note) or by receiving no data for 3-character length or more.

(Note) When the frame size can be calculated from the values of command code, data length, and status, receiving a checksum terminates frame reception. When the received command code is not defined or the frame size cannot be calculated (such as ANSWER command in IDLE mode), receiving no data for a given period terminates frame reception.

Note: The IRQ notification code in tunnel mode does not contain synchronous code and error-detecting signal (checksum). (See Section 6.3.1.2 IRQ Notification.)

Note: This RFID makes a timing correction for data rate using the synchronous code (0x66) input from the host. Specifically, it measures and corrects the period between the first falling of start bit and the third falling (starting of 8th bit of data).

5.2.3 Specifying Data Rate

The system area HW of FeRAM is used to specify data rate of UART.

For more information, see ■HW (2 bytes) in Section 3.3 System Area.

5.2.4 Specifying Response Wait Time

This RFID provides a functionality to specify the response wait time until a response is sent after a command from the host is received to a given time or more. The functionality is specified in the system area HW of FeRAM.

For more information, see ■HW (2 bytes) in Section 3.3 System Area.

5.2.5 Status

Table 5-4 lists the meaning of the response status of the RFID.

Table 5-4 RFID Response Status

Value	Meaning	Description
0x05	Normal end	Terminated normally
0x06	Checksum error	Checksum, parity, stop bit error
0x16	Unimplemented command error	The command was unimplemented one.
0x26	Command parameter error (*)	<ul style="list-style-type: none"> • Address was specified outside FeRAM. • Data length was out of the specification.
0x36	Tunnel mode error	QUERY and ANSWER commands were issued in IDLE state.
0x46	Self-diagnosis error	Write access to FeRAM-Read-Only area (ROSI setting)
0x07	BUSY	RFID command processing in progress

(*) For more information about these errors, see the Administrator's Manual.

5.2.6 Command

Table 5-5 lists the serial communication mode commands supported by this RFID.

Subsequent sections describe each command in detail.

Table 5-5 Command List in Serial Communication Mode

Name	Code	Description
READ	0x08	Reads an RFID data from the host.
WRITE	0x18	Writes a data to RFID from the host.

5.2.6.1 READ

■ Purpose

Reads an RFID data from the host.

■ Command message

● Format

Command code	Start address	Data length n
1 byte	2 bytes	1 byte

● Data field

Field	Setting	Remarks
Command code	0x08	
Start address	Address at which to start reads	· Byte units · Big endian format
Data length n	Size of data to be read · Setting range: 0x01(1) to 0xFE(254)	Byte units

■ Response message

● Format

Status	Data
1 byte	1 to 254 bytes

● Data field

Field	Output value	Remarks
Status	See 5.2.5 Status.	
Data	Data to be read	See Note below.

Note: If the status of a response message from RFID is not normal (error or busy), data will be omitted.

5.2.6.2 WRITE

■ Purpose

Writes a data to RFID from the host.

■ Command message

● Format

Command code	Start address	Data length n	Data
1 byte	2 bytes	1 byte	1 to 251 bytes

● Data field

Field	Setting	Remarks
Command code	0x18	
Start address	Address at which to start writes	· Byte units · Big endian format
Data length n	Size of data to be written · Setting range: 0x01(1) to 0xFB(251)	Byte units
Data	Data to be written	

■ Response message

● Format

Status
1 byte

● Data field

Field	Output value	Remarks
Status	See 5.2.5 Status.	

5.3 Clock Synchronous Serial Communication

This section describes the specification of clock synchronous serial communication.

5.3.1 Communication Specification

Table 5-6 shows this RFID's clock synchronous serial communication specification.

Table 5-6 Clock Synchronous Serial Communication Specification

Data transfer method	Clock synchronous, half-duplex
Data rate	Up to 1 Mbps
I/O timing	<ul style="list-style-type: none"> • Data input at the rising edge of clock • Data output at the falling edge of clock
Character transmission	<ul style="list-style-type: none"> • MSB-first • Data (8 bits) • No start bit • No parity bit • No stop bit

5.3.2 Frame Format

Figure 5-3 illustrates the frame format for clock synchronous serial communication. Table 5-7 shows the field definition.

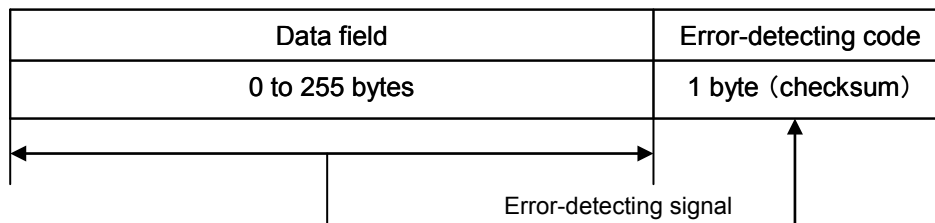

Figure 5-3 Frame Format

Table 5-7 Field Definition

Name	Byte length	Definition
Data field	n	Command message or Response message
Error-detecting code	1	2's complement of the sum of data field's data

Table 5-8 Frame End Condition

Receive command	Frame end condition
Frame size calculation enable	Frame reception ends when checksum is received.
Frame size calculation disable (See Note.)	Frame reception ends when 256-byte data is received.

(Note) Frame size calculation is disabled in the following cases: (1) Command code is not defined. (2) An ANSWER command is issued in IDLE or TUNNEL_MODE1 state (see Figure 7-4).

Note: When the receive command in Table 5-8 is set to "Frame size calculation disable," in order to meet the frame end condition, dummy data must be added (input) to the existing data so that the sum of those data is just 256 bytes.

Note: This LSI starts serial communication processing, when clock is input to the SCK pin. In the case that the number of clock inputs to the SCK pin is less than 1 Byte within $12\text{ms} \pm 25\%$ since the start of serial communication processing, timeout occurs and the communication status is initialized.

5.3.3 Time Chart

Figure 5-4 shows the time chart when clock synchronous serial is used.

t0: The host inputs a clock to the SCK pin and a command data to I/O pins. Pull the IRQ pin up to high.

t1: The host stops the clock input to the SCK pin after inputting command data. The RFID executes command processing internally.

t2: Once the internal command processing is completed, the RFID outputs low to the IRQ pin to send a response.

t3: The host detects the low output of the IRQ pin and inputs a clock to the SCK pin. The RFID outputs a response data in sync with the clock input. The RFID stops low output to the IRQ pin once the clock input starts.

The host stops the clock after the response data reception is completed.

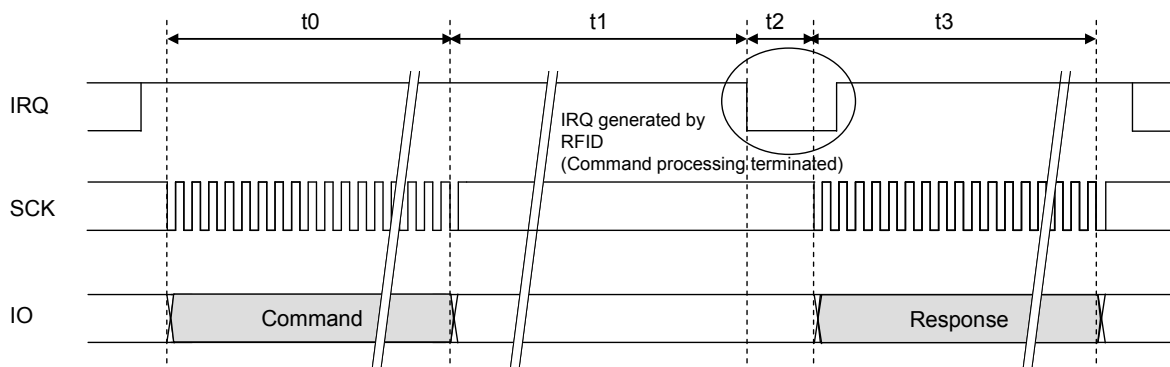

Figure 5-4 Time Chart

5.3.4 Status

The specification of status is the same as that of UART. See Section 5.2.5 Status.

5.3.5 Command

The specification of command is the same as UART. See Section 5.2.6 Command.

Chapter 6 Tunnel Mode

6.1 Tunnel Mode Sequence

This section describes the sequence of tunnel mode, which is shown in Figure 6-1.

SNo.1: Reader/writer sends a tunnel mode command to RFID.

SNo.2: RFID receives the tunnel mode command and issues an interrupt request (IRQ) to the host.

SNo.3: If VDD2 is not applied, the host applies VDD2.

SNo.4: The host sends a QUERY command (inquiry) to RFID.

SNo.5: RFID sends a response to the QUERY command to the host. The response includes data of the tunnel mode command in step SNo.1.

SNo.6: The host sends an ANSWER command (notification of the result) to RFID. The command includes data to be sent to reader/writer.

SNo.7: RFID receives the ANSWER command and sends a response (processing result; Normal end or Error) to the command to the host.

SNo.8: After sending the response to the ANSWER command in step SNo.7, RFID sends the data of the ANSWER command to reader/writer as a tunnel mode response.

For more information about tunnel mode operation, see Section 7.2 State Transition Diagram in Operation Mode, Section 7.3 Flow Chart in Tunnel Mode, or other related section. Flow Chart in

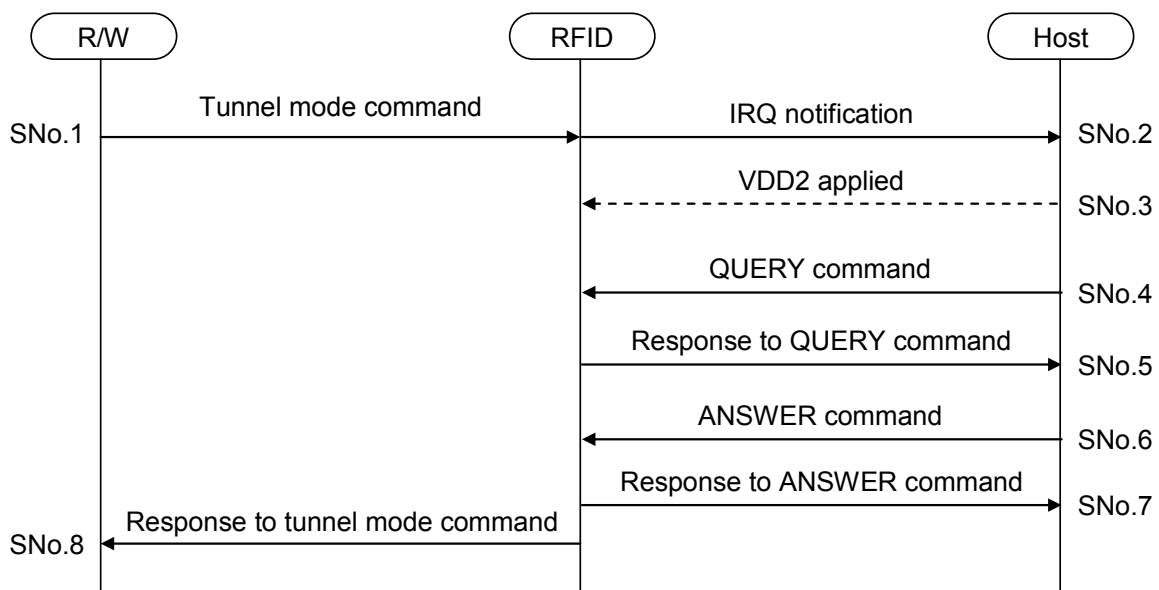

Figure 6-1 Tunnel Mode Sequence

6.2 Communication between Reader/Writer and RFID

This section describes the communication between Reader/Writer and RFID in tunnel mode, based on JISX6319-4 and ISO/IEC14443 TypeB.

6.2.1 Using JISX6319-4

READ and WRITE commands, same as those of RF communication mode, are used.

Use the given bits corresponding to the block number to set the tunnel mode commands. For more information, see Section 4.2.5.6 Block.

For information on how to set block list and block data, see Section 4.2.5.7 Block List.

6.2.2 Using ISO/IEC14443

READ and WRITE commands, same as those of RF communication mode, are used.

Use the given bits of address (P1, P2) to set the tunnel mode commands. For more information, see Section 4.3.8.5 Address.

For information on how to set data, see Section 4.3.8.6 Data.

6.3 Communication between Host and RFID

This section describes the UART communication between the host and RFID in tunnel mode.

6.3.1 .Using UART

The specification when using UART is described below.

6.3.1.1 Communication Specification

The specification for UART communication is the same as that for serial communication mode. See Section 5.2 UART.

QUERY and ANSWER commands are provided only for tunnel mode. For more information about commands, see Section 6.4 Command.

6.3.1.2 IRQ Notification

Once this RFID receives a tunnel mode command from reader/writer, it send an IRQ to the host.

When UART is used, IRQ is output from the IRQ pin. It is also possible to output it from the TX pin by setting the system area HW parameter IRQSEL. For more information about IRQSEL, see ■HW (2 bytes) in Section 3.3 System Area.

Figure 6-2 shows the IRQ waveform when IRQ is not sent from the TX pin (IRQSEL = 0).

IRQ signal is a pulse of 1.28 ms \pm 25%. When the host receives an IRQ and detects that the supply voltage VDD2 is not applied, it applies VDD2 and sends a QUERY command to the RFID. The RFID can receive RX of UART at the falling edge of IRQ.

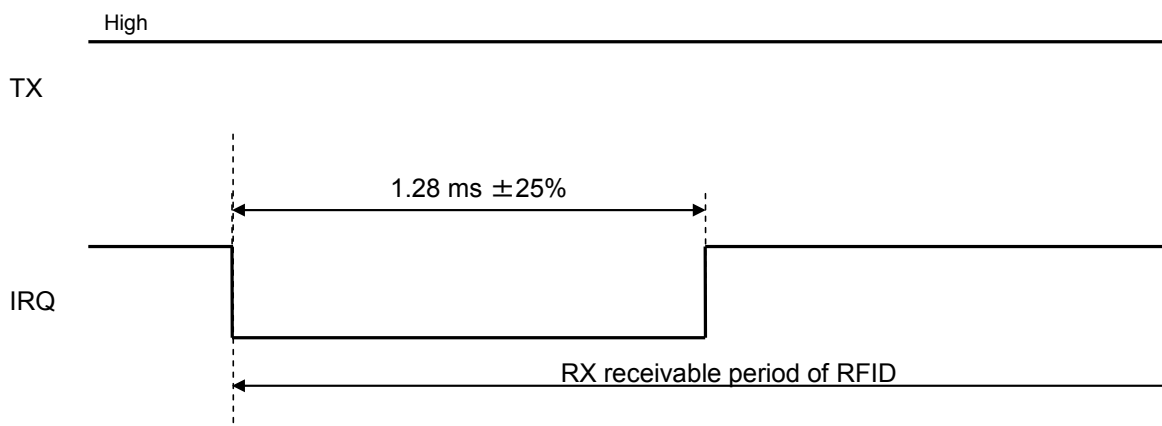

Figure 6-2 UART Signal Waveform When Sending IRQ (IRQSEL = 0)

Next, for IRQ notification from the TX pin (IRQSEL = 1), Figure 6-3 shows IRQ waveform and Table 6-1 shows IRQ code. The RFID's TX pin outputs the notification code 0xFE and IRQ pin outputs a low pulse of 1.28 ms \pm 25% from the timing of bit 2 of TX. The IRQ code of TX does not contain checksum.

When the host receives an IRQ and detects that the supply voltage VDD2 is not applied, it applies VDD2 and sends a QUERY command to the RFID. At this time, the RFID can receive RX (full-duplex communication enabled) immediately after TX and IRQ transition to low. Full-duplex communication is enabled only for IRQ notification.

In addition, if the RFID does not receive a QUERY command from the host even when the maximum wait time for QUERY command specified in the system area QWT elapses after the IRQ pin outputs low, it detects a timeout. For more information, see Section 7.3 Flow Chart in Tunnel Mode.Flow Chart in

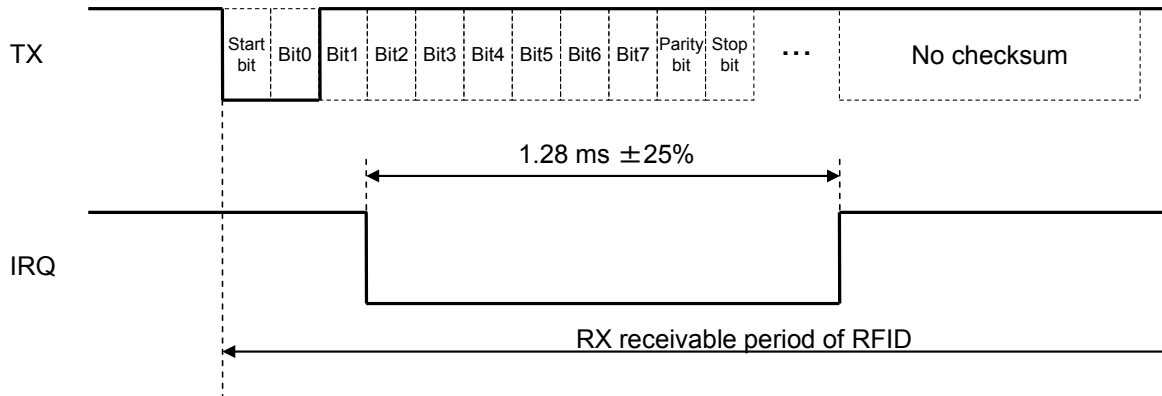

Figure 6-3 UART Signal Waveform When sending IRQ (IRQSEL = 1)

Table 6-1 IRQ Notification Code

Size	1 byte
Output value	0xFE

6.3.2 Using Clock Synchronous Serial

The specification when using clock synchronous serial is described below.

6.3.2.1 Communication Specification

The specification for clock synchronous serial communication is the same as that for serial communication mode. See Section 5.3 Clock Synchronous Serial Communication.

QUERY and ANSWER commands are provided only for tunnel mode. For more information about commands, see Section 6.4 Command.

6.3.2.2 IRQ Notification

Once this RFID receives a tunnel mode command from reader/writer, it send an IRQ to the host.

When clock synchronous serial interface is used, IRQ is output only from the IRQ pin.

Figure 6-4 shows the IRQ waveform for clock synchronous serial.

The RFID outputs low to the IRQ pin. When the host detects IRQ = L and detects that the supply voltage VDD2 is not applied, it applies VDD2 and then inputs a clock to the SCK pin and at the same time sends a QUERY command to the RFID. Once the RFID detects that a clock is input to the SCK pin, it stops low output to the IRQ pin.

In addition, if the RFID does not receive a QUERY command from the host even when the maximum wait time for QUERY command specified in the system area QWT elapses after the IRQ pin outputs low, it detects a timeout. For clock synchronous, retry of sending IRQ is not performed. For more information, see Section 7.3 Flow Chart in Tunnel Mode.

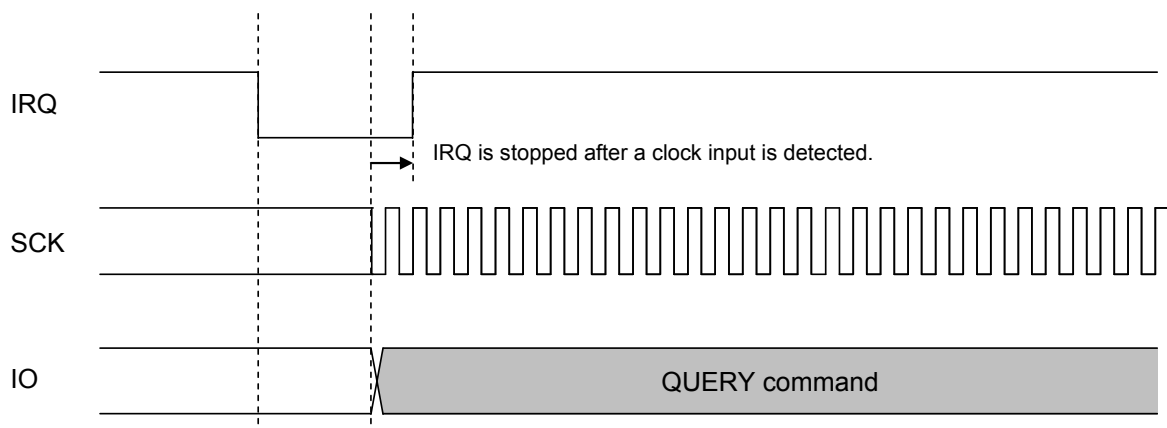

Figure 6-4 Clock Synchronous Serial IRQ Waveform

6.3.2.3 Configuring System Area (UARTSP Setting)

For IRQ notification in tunnel mode command reception, in order to support the case that VDD2 is not applied (SEL pin is disabled), set bits 7, 6, and 5 of the system area HW (2 bytes) parameter UARTSP to 111 when using clock synchronous.

Table 6-2 QUERY Response Mode

VDD2 state	Serial interface selection (UART or Clock synchronous)
Applied	Use the SEL pin.
Not applied	Use the UARTSP setting.

6.3.3 Response to QUERY Command

When a response to QUERY command in tunnel mode is sent, the RFID reports the content of the command from reader/writer to the host.

The address setting for response to QUERY is shown in Figure 6-5.

Bit 7 of upper byte is fixed to 0. Bits 6 and 4 indicate mode.

Table 6-3 shows the meaning of mode of upper byte bits 5 and 4. This bit indicates whether the communication in tunnel mode is plaintext (unencrypted) or encrypted (private or family key).

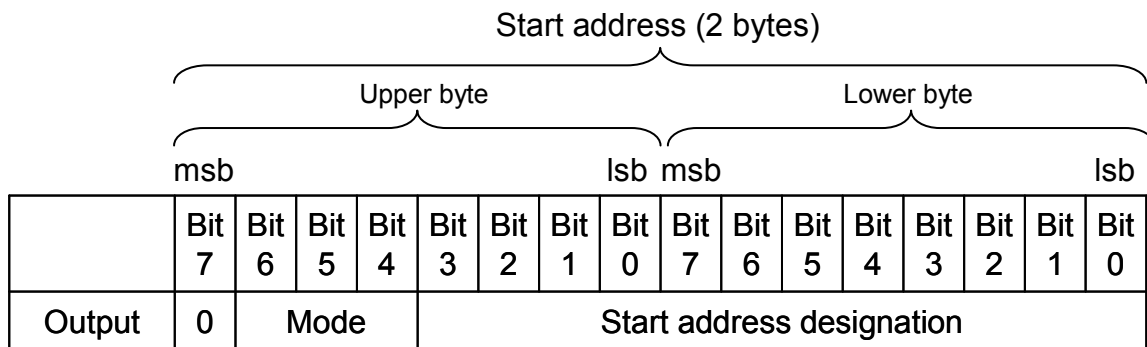

Figure 6-5 Address Setting for Response to QUERY Command

Table 6-3 QUERY Response Mode

Upper byte			Meaning
Bit 6	Bit 5	Bit 4	
1	0	0	Tunnel mode
Others			Reserved

6.3.4 Timeout

In tunnel mode command processing for communication between host and RFID, a timeout processing is applied if the host sends no response to QUERY and ANSWER commands.

Figure 6-6 shows the wait time for commands in tunnel mode.

Subsequent section describes the wait time for QUERY and ANSWER commands.

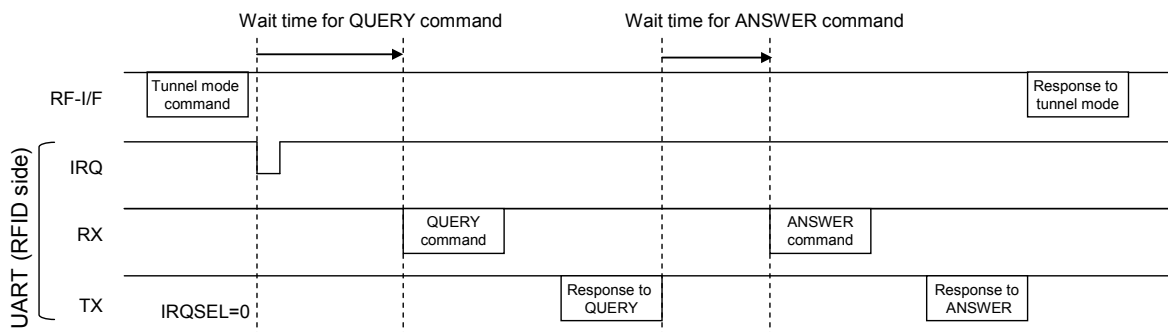

Figure 6-6 Wait Time for Commands

Note: In timeout measurement processing for UART, the start of command is detected at the start of data field, not the start of synchronous code.

6.3.4.1 Wait Time for QUERY Command

The time sequence (QRTRY = 1) for timeout of waiting QUERY command (no response from the host) is shown in Figure 6-7. The measurement of timeout starts when the state of IRQ pin changes to low from high. When UART is used, a timeout time is the longer of QWT setting time or UARTWT setting time.

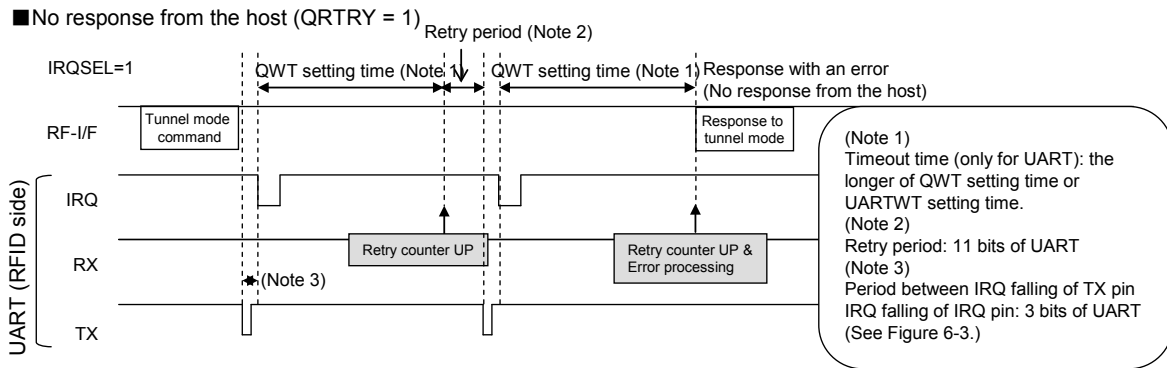

Figure 6-7 Timeout of Waiting for QUERY Command (No Response from the Host)

Next, the time sequence when the RFID receives a command other than QUERY from the host while it waits a QUERY command is shown in Figure 6-8. In this case, the retry counter increases by receiving a command other than QUERY.

For more information, see Section 7.3 Flow Chart in Tunnel Mode. Flow Chart in

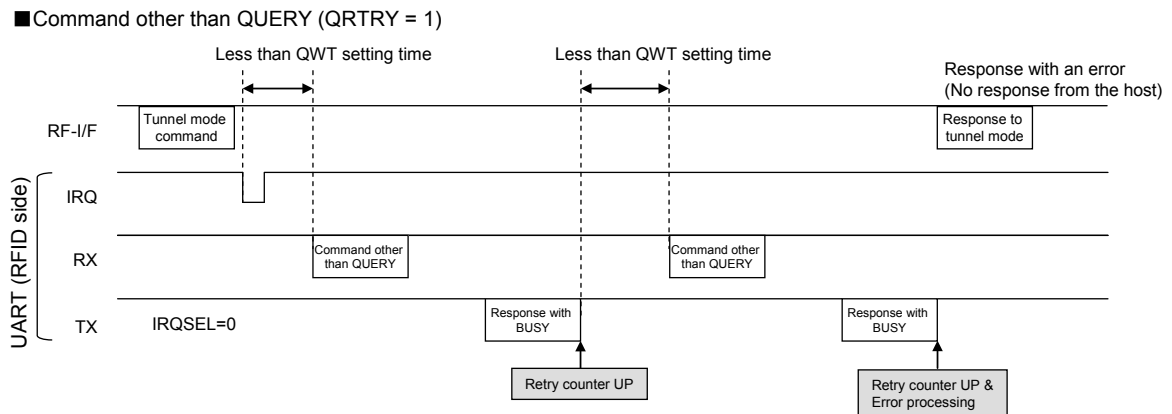

Figure 6-8 Timeout of Waiting for QUERY Command (Command Other Than QUERY)

6.3.4.2 Wait Time for ANSWER Command

The time sequence when the RFID receives no response from the host while it waits an ANSWER command is shown in Figure 6-9. The measurement of timeout starts immediately after the first response (to normal

QUERY command) is sent.

■ No response from the host

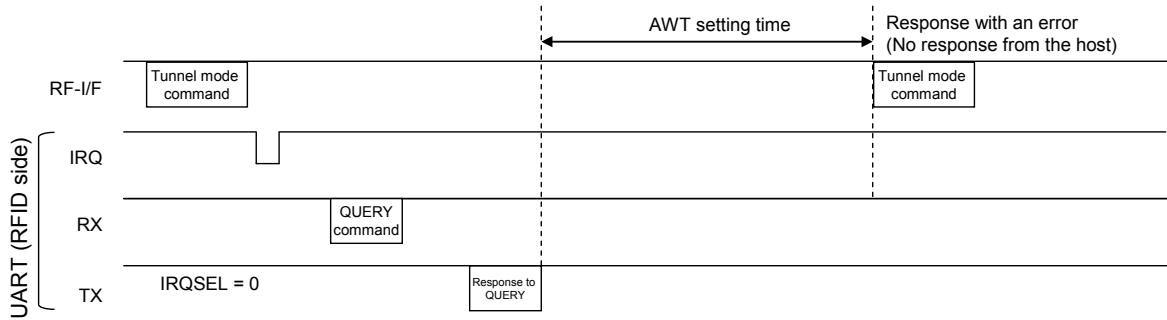

Figure 6-9 Timeout of Waiting for ANSWER Command (No Response from the Host)

Next, the time sequence when the RFID receives a command other than ANSWER from the host while it waits an ANSWER command is shown in Figure 6-10. Note that the timeout measurement time does not include the time from serial communication command issue to the response to the command.

■ Command other than ANSWER

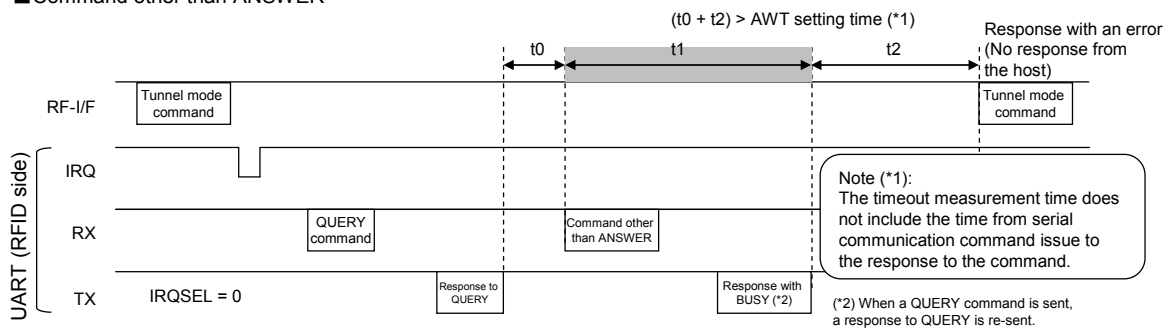

Figure 6-10 Timeout of Waiting for ANSWER Command (Command Other than ANSWER)

6.4 Command

The tunnel mode commands supported by this RFID fall into two types:

RF-interface-side commands between reader/writer and RFID and serial-interface-side commands between the host and RFID.

These commands are shown in Table 6-4 and Table 6-5.

Subsequent sections describe each command in detail.

Table 6-4 RF Interface Command List in Tunnel Mode

Name	Code		Description
	JISX6319-4	ISO/IEC 14443TypeB	
READ	0x06	0xB0	Reads data of the host from reader/writer. (Command code is the same as that for RF communication mode)
WRITE	0x08	0xD6	Writes data to the host from reader/writer. (Command code is the same as that for RF communication mode)

Table 6-5 Serial-Communication-Side Commands List in Tunnel Mode

Name	Code	Description
QUERY	0x28	The host inquires about the content of tunnel mode command to RFID.
ANSWER (normal end)	0xF8	The host reports the processing result (normal end) of tunnel mode command to RFID.
ANSWER (error)	0xE8	The host reports the processing result (error) of tunnel mode command to RFID.

6.4.1 Read in Tunnel Mode

■ Purpose

Reads data of the host from reader/writer via RFID.

1. Read Command in Tunnel Mode (Reader/Writer to RFID)

■ JIX6319-4

● Format

Command code	PICC identifier	No. of service file identifiers (k)	List of service file identifiers	No. of blocks (m)	Block list
1 byte	8 bytes	1 byte	2×k byte	1 byte	2×m or 3×m bytes

● Data field

Field	Setting	Remarks
Command code	0x06	
PICC identifier	PICC identifier acquired by REQ command described in Section 4.2.6.1 REQ.	
No. of service file identifiers (k)	Number of service files Setting range: 0x01(1) to 0x0F(15)	When the range other than the range on the left column is set, the RFID responds with an error.
List of service file identifiers	Don't care (Setting example: 0x0900)	When specifying multiple services, the RFID responds with an error if all service files are not set to the same value.
No. of blocks (m)	Number of blocks specified in block list Setting range: · RF communication mode: 0x01(1) to 0x0D(13) · Other communication: 0x01(1) to 0x0F(15)	When the range other than the range on the left column is set, the RFID responds with an error.
Block list	Block list of data to be read For information about how to set, see the following: · See 4.2.5.6 Block. · See 4.2.5.7 Block List.	

■ ISO/IEC14443 TypeB

● Format

CLA	INS	P1	P2	Le
1 byte	1 byte	1 byte	1 byte	1 byte

● Data field

Field	Setting	Remarks
CLA	0x00	Responds with an error, except 0x00.
INS	0xB0	

P1	Start address of data to be read · See 4.3.8.5 Address.	
P2	Start address of data to be read · See 4.3.8.5 Address.	
Le	Byte length of data to be read · Setting range: 0x01(1) to 0xFB(251)	

2. QUERY Command (Host to RFID)

- Format

Command code
1 byte

- Data field

Field	Setting	Remarks
Command code	0x28	

3. QUERY Response (RFID to Host)

- Format

Response code	Start address	Data length n
1 byte	2 bytes	1 byte

- Data field

Field	Setting	Remarks
Response code	0x08	
Start address	Address at which to start reads	· Byte units · Big endian format
Data length n	Size of data to be read	Byte units

4. ANSWER Command (Host to RFID)

- Format

Command code	Data
1 byte	n bytes

- Data field

Field	Output value	Remarks
Command code	0xF8: Normal end 0xE8: Error	
Data	Data of the range specified by the response to the QUERY command	See Note below.

Note: If the status of the ANSWER command is "error", omit the data.

5. ANSWER Response (RFID to Host)

- Format

Status
1 byte

- Data field

Field	Output value	Remarks
Status	See 5.2.5 Status.	

6. Read Response in Tunnel Mode (RFID to R/W)

- JIX6319-4

- Format

Response code	PICC identifier	Status flag 1	Status flag 2	No. of blocks (m)	Block data
1 byte	8 bytes	1 byte	1 byte	1 byte	16×m bytes

- Data field

Field	Ourput value	Remarks
Response code	0x07	
PICC identifier	See 4.2.5.2 PICC (Proximity IC Card) Identifier.	
Status flag 1	See 4.2.5.8 Status Flag.	
Status flag 2	See 4.2.5.8 Status Flag.	
No. of blocks (m)	Number of blocks specified by the tunnel mode read command	Omitted when the status is not "Normal end"
Block data	Data specified by the ANSWER command · See 4.2.5.7 Block List.	Omitted when the status is not "Normal end"

- ISO/IEC14443 TypeB

- Format

Data	SW1	SW2
1 to 251 bytes	1 byte	1 byte

- Data field

Field	Output value	Remarks
Data	Read data See 4.3.8.6 Data.	Omitted when the status word is not "Normal end"
SW1	See 4.3.8.7 Status Word.	
SW2	See 4.3.8.7 Status Word.	

6.4.2 Write in Tunnel Mode

■ Purpose

Writes a data to the host from reader/writer, via RFID.

1. Write Command in Tunnel Mode (R/W to RFID)

■ JIX6319-4

● Format

Command code	PICC identifier	No. of service file identifiers (k)	List of service file identifier	No. of blocks (m)	Block list	Block data
1 byte	8 bytes	1 byte	2×k bytes	1 byte	2×m or 3×m bytes	16×m bytes

● Data field

Field	Setting	Remarks
Command code	0x08	
PICC identifier	PICC identifier acquired by REQ command described in Section 4.2.6.1 REQ.	
No. of service file identifiers (k)	Number of service files Setting range: 0x01(1) to 0x0B(11)	When the range other than the range on the left column is set, the RFID responds with an error.
List of service file identifier	Don't care (Setting example: 0x0900)	When specifying multiple services, the RFID responds with an error if all service files are not set to the same value.
No. of blocks (m)	Number of blocks specified by block list Setting range: · 1 to 8 service files: 0x01(1) to 0x0C(12) · 9 to 11 service files: 0x01(1) to 0x0B(11)	When the range other than the range on the left column is set, the RFID responds with an error.
Block list	Block list of data to be written For information about how to set, see the following: · See 4.2.5.6 Block. · See 4.2.5.7 Block List.	
Block data	See 4.2.5.7 Block List.	

■ ISO/IEC14443 TypeB

■ Format

CLA	INS	P1	P2	Lc	Data
1 byte	1 byte	1 byte	1 byte	1 byte	1 to 248 bytes

■ Data field

Field	Setting	Remarks
CLA	0x00	Responds with an error, except 0x00

INS	0xD6	
P1	Start address of data to be written · See 4.3.8.5 Address.	
P2	Start address of data to be written · See 4.3.8.5 Address.	
Lc	Byte length of Data block · Setting range: 0x01(1) to 0xF8(248)	
Data	Write data · See 4.3.8.6 Data.	

2. QUERY Command (Host to RFID)

- Format

Command code
1 byte

- Data field

Field	Setting	Remarks
Command code	0x28	

3. QUERY Response (RFID to Host)

- Format

Response code	Start address	Data length n	Data
1 byte	2 bytes	1 byte	n bytes

- Data field

Field	Setting	Remarks
Response code	0x18	
Start address	Address at which writes start	· Byte units · Big endian format
Data length n	Size of data to be written	Byte units
Data	Data to be written to the host	

4. ANSWER Command (Host to RFID)

- Format

Command code
1 byte

- Data field

Field	Output value	Remarks
Command code	0xF8: Normal end 0xE8: Error	

5. ANSWER Response (RFID to Host)

- Format

Status
1 byte

- Data field

Field	Output value	Remarks
Status	See 5.2.5 Status.	

6. Write Response in Tunnel Mode (RFID to R/W)

- JIX6319-4

- Format

Response code	PICC identifier	Status flag 1	Status flag 2
1 byte	8 bytes	1 byte	1 byte

- Data field

Field	Output value	Remarks
Response code	0x09	
PICC identifier	See 4.2.5.2 PICC (Proximity IC Card) Identifier.	
Status flag 1	See 4.2.5.8 Status Flag.	
Status flag 2	See 4.2.5.8 Status Flag.	

- ISO/IEC14443 TypeB

- Format

SW1	SW2
1 byte	1 byte

- Data field

Field	Output value	Remarks
SW1	See 4.3.8.7 Status Word.	
SW2	See 4.3.8.7 Status Word.	

Chapter 7 Annex

7.1 Exclusive Control

While in operation mode, this RFID performs an exclusive control not to receive other commands.

Figure 7-1 shows the exclusive control period. The period is from the start of an operation mode command to the end of the response to the command. In tunnel mode, the period is from the start of the tunnel mode command from reader/writer (see SNo.1 in Figure 6-1 Tunnel Mode Sequence) to the end of the response to the command from RFID to reader/writer (see SNo.8 in Figure 6-1 Tunnel Mode Sequence).

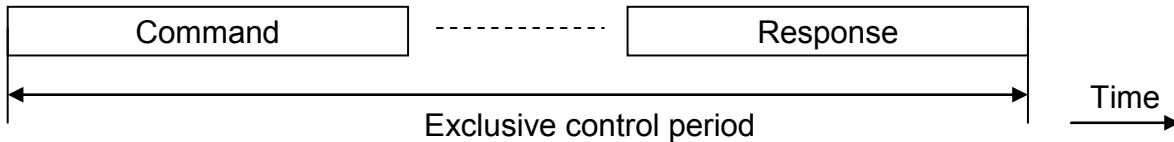

Figure 7-1 Exclusive Control Period

Table 7-1 shows the operations in exclusive control period for each operation mode. Illegular cases that are not generated normally are indicated with parenthesis.

If a command from the host is parity or checksum error, the RFID responds with an error (error code: 0x06), not with BUSY. It responds with BUSY for unimplemented command.

In tunnel mode, the RFID operation differs between before and after IRQ output following the reception of a tunnel mode command from reader/writer.

Table 7-1 Operation during Exclusive Control (Irregular Case in Parenthesis)

Current operation mode	Receive command		Operation to a receive command	
	Operation mode	From		
RF communication mode	(RF communication mode)	(R/W)	(No response)	
	Serial communication mode	Host	Responds with BUSY	Responds with 0x06 for Parity or Checksum error
	(Tunnel mode)	(R/W)	(No response)	
	Tunnel mode	(Host)	(Responds with BUSY)	Responds with 0x06 for Parity or Checksum error
serial communication mode	RF communication mode	R/W	No response	
	(Serial communication mode)	(Host)	(No response)	
	Tunnel mode	R/W	No response	
	(Tunnel mode)	(Host)	(No response)	
Tunnel mode	(RF communication mode)	(R/W)	(No response)	
	Serial communication mode	Host	Responds with BUSY (See Note.)	Responds with 0x06 for Parity or Checksum error
	(Tunnel mode)	(R/W)	(No response)	
	Tunnel mode	Host	See 6.1 Tunnel Mode Sequence.	

(Note) In tunnel mode, this RFID sends no response to the serial communication command for the period between QUERY command reception and response to the command or the period between ANSWER command reception and response to the command. (This operation is the same as the exclusive control operation in serial communication mode.)

Figure 7-2 shows the detail of exclusive control in tunnel mode when UART serial interface is used.

When the RFID receives a command from the host during tunnel mode command reception and before IRQ output, it sends a response with BUSY and then outputs IRQ after the wait time specified by the UARTWT setting elapses.

When the RFID receives a command (other than QUERY) from the host after IRQ output, it responds with BUSY to the command.

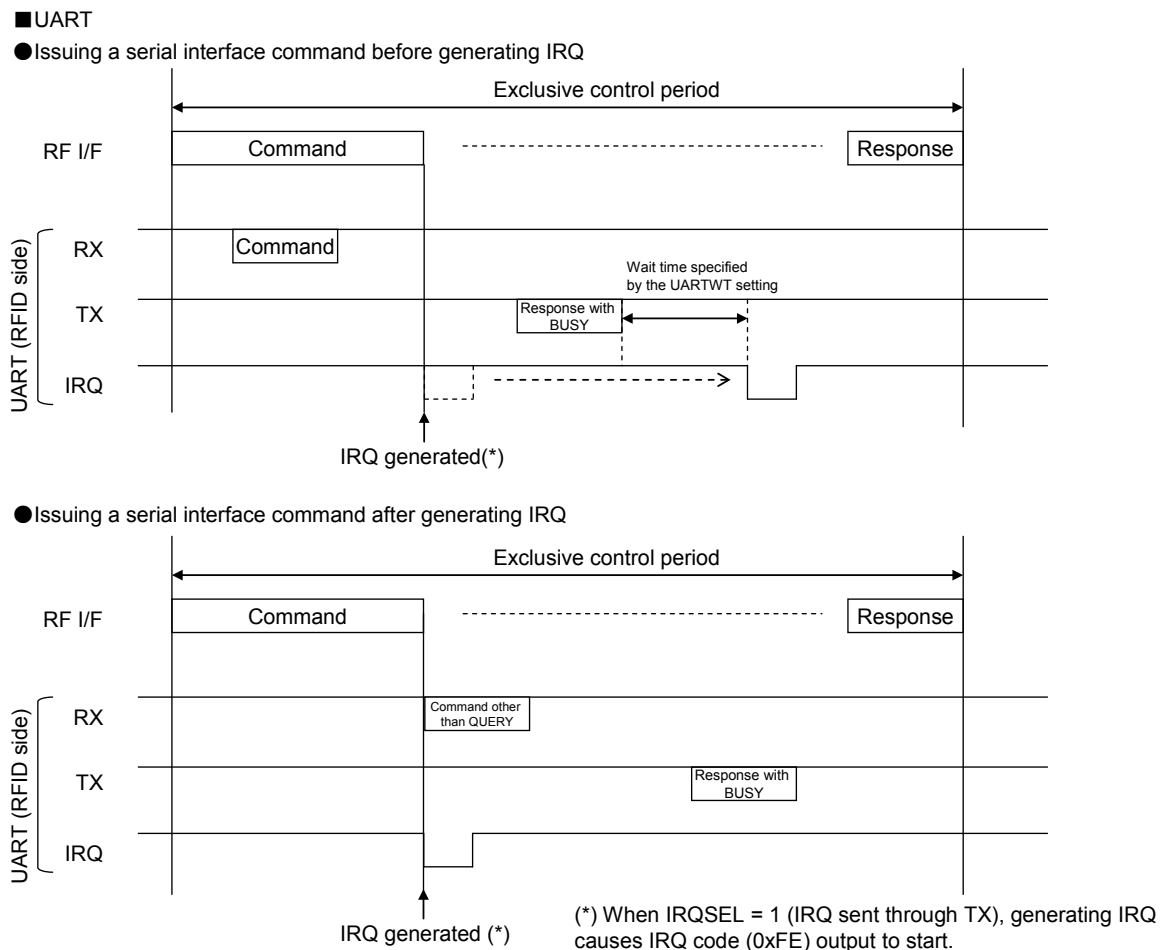

Figure 7-2 Exclusive Control in Tunnel Mode (UART)

Figure 7-3 shows the detail of exclusive control in tunnel mode when clock synchronous serial interface is used.

When the RFID receives a command from the host during tunnel mode command reception and before IRQ output, it sends a response with BUSY and then outputs IRQ again approximately 1 μ s after the response is terminated.

When the RFID receives a command (other than QUERY) from the host after IRQ output that reports a tunnel mode command is received, it responds with BUSY to the command.

■ Clock synchronous

● Issuing a serial interface command before generating IRQ that reports a tunnel mode command is received

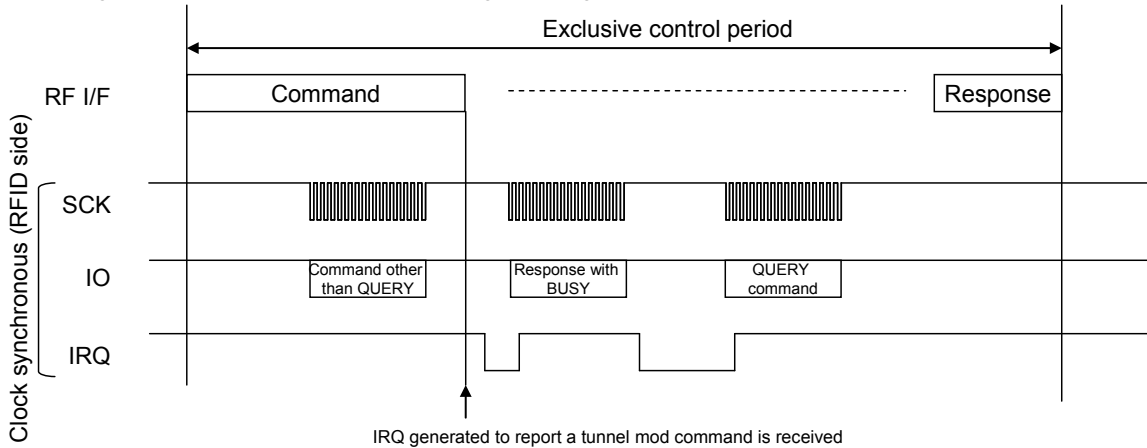

● Issuing a serial interface command after generating IRQ that reports a tunnel mode command is received

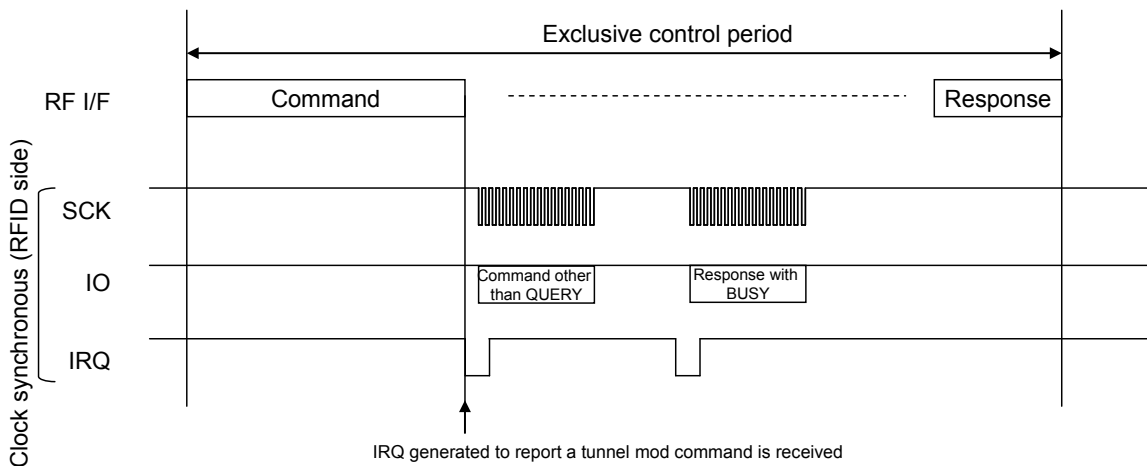

Figure 7-3 Exclusive Control in Tunnel Mode (Clock Synchronous)

7.2 State Transition Diagram in Operation Mode

Figure 7-4 shows the state transition diagram of this RFID in operation mode.

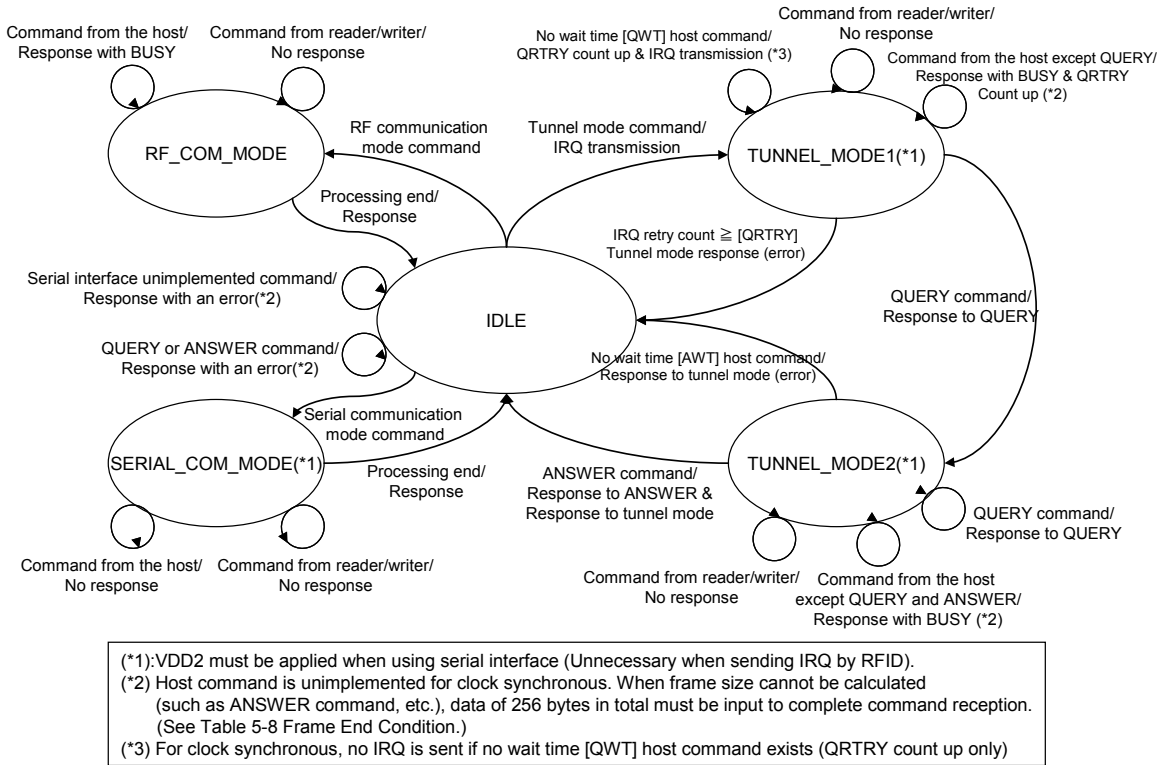
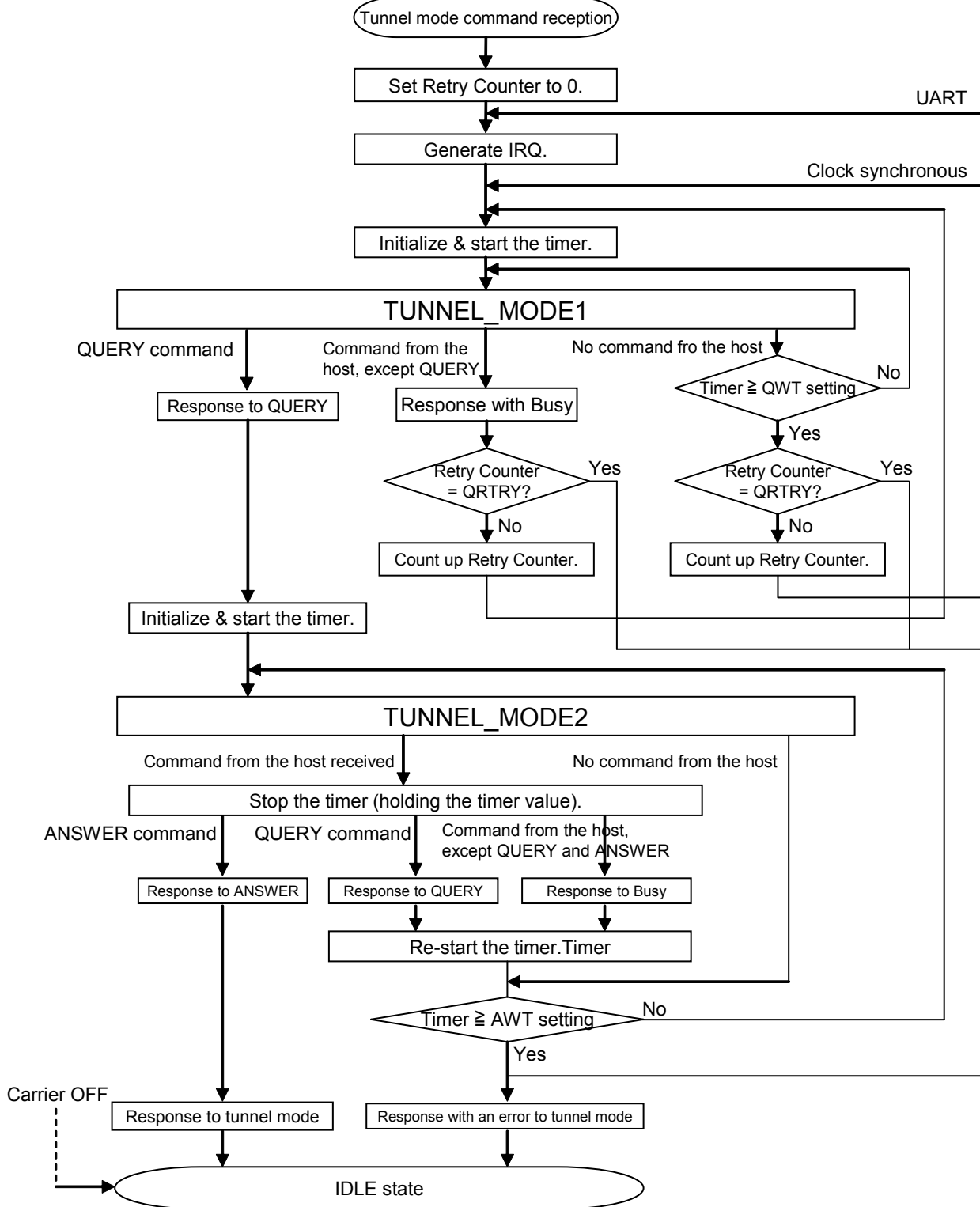

Figure 7-4 State Transition Diagram in Operation Mode

7.3 Flow Chart in Tunnel Mode

Figure 7-5 illustrates a flow chart for tunnel mode. When no command is sent from the host in the TUNNEL_MODE1 state, the RFID re-sends an IRQ for UART but does not re-send for clock synchronous.



Regardless of the state after tunnel mode reception, a Carrier OFF causes the RFID to transition to IDLE state.

Figure 7-5 Flow Chart in Tunnel Mode

Figure 7-6 illustrates the sequence of receiving commands other than QUERY in TUNNEL_MODE1. For unimplemented commands, a wait time of the frame end condition is further added. This specification is applied to UART only.

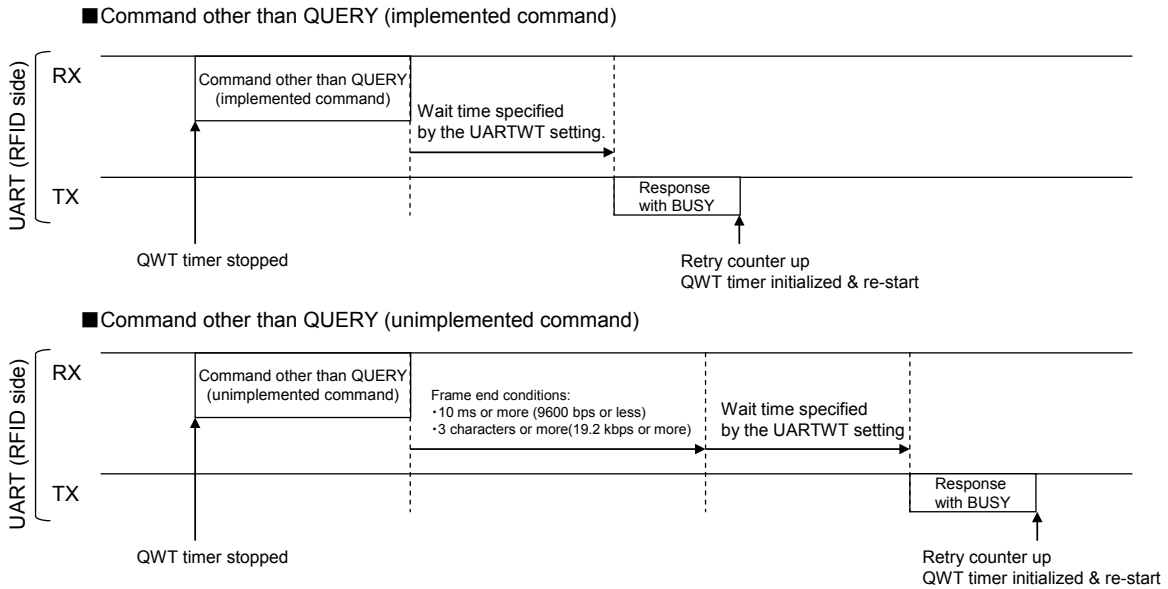

Figure 7-6 Sequence during Command Reception except TUNNEL_MODE1 QUERY (UART only)

7.4 Maximum Command Processing Time (UART)

When specifying the timing to re-send a command of the serial interface (UART), the maximum command processing time must be set to prevent the command from overlapping previous command's transmit/receive periods.

illustrates the definition of command processing time. Additionally, the formula used to calculate the maximum processing time of each command of the serial interface is shown in . t_{UARTWT} has an error of $\pm 25\%$, so is set to 1.25 times.

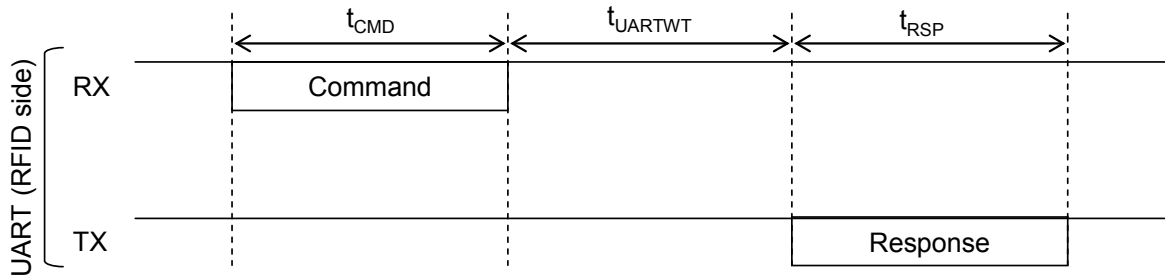

Figure 7-7 Command Processing Time

Table 7-2 Maximum Command Processing Formula (UART)

	t_{CMD}	t_{UARTWT}	t_{RSP}
READ	$\frac{6bytes \times (11 + \alpha)}{Baudrate}$	UARTWT setting $\times 1.25$	$\frac{257bytes \times 11}{Baudrate}$
WRITE	$\frac{257bytes \times (11 + \alpha)}{Baudrate}$	UARTWT setting $\times 1.25$	$\frac{3bytes \times 11}{Baudrate}$
QUERY	$\frac{3bytes \times (11 + \alpha)}{Baudrate}$	UARTWT setting $\times 1.25$	$\frac{257bytes \times 11}{Baudrate}$
ANSWER	$\frac{257bytes \times (11 + \alpha)}{Baudrate}$	UARTWT setting $\times 1.25$	$\frac{3bytes \times 11}{Baudrate}$

α refers to the period between characters (from stop bit to start bit of next character)

Chapter 8 Electrical characteristics



Attention

The technical information described in this document is intended only to show the main characteristics and application circuit examples of the product. No license is granted in and to any intellectual property right or other right owned by Panasonic Corporation or any other company. Therefore, no responsibility is assumed by our company as to the infringement upon any such right owned by any other company which may arise as a result of the use of technical information described in this document.

Use caution regarding the orientation of the LSI during use. Mounting of the LSI in an incorrect orientation may cause smoke or fire.

Type	CMOS integrated circuit with built-in FeRAM
Application	Various systems
Function	Dual interface RFID

A. Absolute Maximum Ratings Note 1)

$V_{SS} = 0\text{ V}$

Parameter		Symbol	Rating	Unit
A1	Supply voltage Note 2)	V_{DD2}	-0.3 to +4.6	V
A2		V_{DD1}	-0.3 to +4.6	V
A3		V_{DD}	-0.3 to +2.5	V
A4	Voltage antenna terminals swing (VB Peak to peak) Note3)	V_{CBA}	± 30	V
A5	Input pin voltage (TEST, NCLP)	V_{I2}	-0.3 to +4.6	V
A6	Input pin voltage (SEL, RX)	V_{I3}	-0.3 to +6.0	V
A7	Input/output pin voltage (TX3V)	V_{IO1}	-0.3 to +4.6	V
A8	Input/output pin voltage (TX5V)	V_{IO2}	-0.3 to +6.0	V
A9	Output pin voltage (IRQ3V)	V_{O1}	-0.3 to +4.6	V
A10	Output pin voltage (IRQ5V)	V_{O2}	-0.3 to +6.0	V
A11	Output current	I_O	+12	mA
A12	Storage temperature Note 3)	T_{stg}	-40 to 85	$^{\circ}\text{C}$
A13	Operating ambient temperature	T_{opr}	-20 to 85	$^{\circ}\text{C}$

Note 1) The absolute maximum ratings are the limit values beyond which the IC may be damaged.

Operation is not guaranteed under these conditions.

Note 2) V_{DD1} and V_{DD} are not external-power supply input pins.

Note 3) Voltage antenna terminals swing (V_{CBA}) is shown as follows.

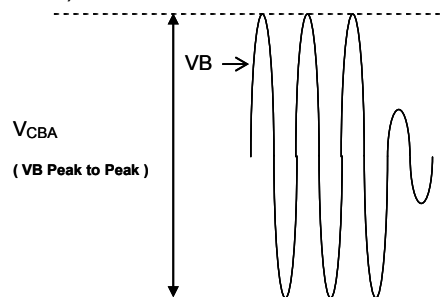

Usage Notes

1. Decoupling capacitor should be connected between VDD2 and VSS, at as a short distance as possible.
2. Decoupling capacitor should be connected between VDD1 and VSS, and Between VDD and VSS, respectively at as a short distance as possible.

Between VDD and VSS : 0.1 μ F

Between VDD1 and VSS : 0.1 μ F

Between VDD1 and VSS : 0.1 μ F

B. Operating Conditions

$T_a = -20^{\circ}\text{C}$ to 85°C , $V_{SS} = 0\text{ V}$

Parameter	Symbol	Conditions	Limits			Unit
			Min	Typ	Max	
B1	Supply voltage VDD2	V_{DD2}	See Conditions 1) and 2).			V
B2	Pullup voltage for 5V tolerant I/O (TX5V, IRQ5V)	V_{PU5}	4.5	-	5.5	V

Reference Value

$T_a = -20^{\circ}\text{C}$ to 85°C , $V_{SS} = 0\text{ V}$

Parameter	Symbol	Conditions	Limits			Unit
			Min	Typ	Max	
B3	Output voltage VDD1	V_{DD1}	See Conditions 1) and 2), or D9 (RF = High) on page 10.			V
B4	Output voltage VDD	V_{DD}	See Conditions 1) and 2), or D9 (RF = High) on page 10.			V

Condition 1)

■ $V_{EXT} = 4.5\text{ V}$ to 5.5 V

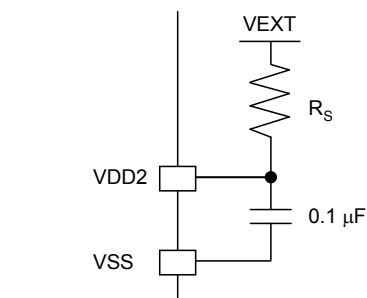

Fig. 1

- When the external supply voltage $V_{EXT} = 4.5\text{ V}$ to 5.5 V , connect a 5.1-k Ω resistor R_S between VEXT and VDD2 as shown in Fig. 1.
- The tolerance of resistor R_S must be within $\pm 5\%$.
- Set NCLP to low to turn on the internal clamp circuit.

Condition 2)

■ $V_{EXT} = 1.8\text{ V}$ to 3.6 V

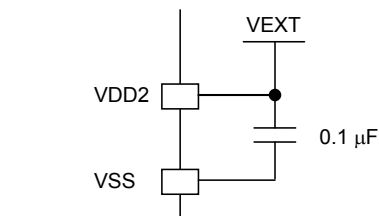

Fig. 2

- When the external supply voltage $V_{EXT} = 1.8\text{ V}$ to 3.6 V , connect VDD2 to VEXT directly as shown in Fig. 2.
- Set NCLP to high to turn off the internal clamp circuit.

C. Electrical Characteristics

D.C. Characteristics

Ta = -20°C to 85°C, V_{SS} = 0 V

Parameter	Symbol	Conditions	Limits			Unit	
			Min	Typ	Max		
C1	Operating supply current of VDD2	I _{DD2A}	See condition 1) (V _{EXT} = 5.5 V) on page 4.	-	430	500	μA
C2	Operating supply current of VDD2	I _{DD2B}	See condition 2) (V _{EXT} = 3.6 V) on page 4.	-	310	500	μA

Reference Value

Ta = -20°C to 85°C, V_{SS} = 0 V

Parameter	Symbol	Conditions	Limits			Unit	
			Min	Typ	Max		
C3	Operating supply current of VDD1	I _{DD1}	V _{DD1} = 2.0 V, with 13.56-MHz clock input between VA and VB pins for RF communication.	-	220	400	μA

Note 5) The value specified in C3 is for reference only and is inspected in the IC manufacturing process based on the RF communication standards.

I/O Pin Characteristics
 $T_a = -20^{\circ}\text{C to } 85^{\circ}\text{C}, V_{SS} = 0\text{ V}$

Parameter	Symbol	Conditions	Limits			Unit
			Min	Typ	Max	

Input Pin: TEST

C4	Input voltage (Low)	V_{IL1}		0	-	$0.3 \times V_{DD2}$	V
C5	Input leakage current	I_{LK1}	Fixed to low	-10	0.02	+10	μA

Input Pin: NCLP

C6	Input voltage (High)	V_{IH2}		$0.7 \times V_{DD2}$	-	V_{DD2}	V
C7	Input voltage (Low)	V_{IL2}		0	-	$0.3 \times V_{DD2}$	V
C8	Input leakage current	I_{LK2}		-10	0.02	+10	μA

Input Pin: RX, SEL (5 V Tolerant)

C9	Input voltage (High)	V_{IH3}		$0.6 \times V_{DD2}$	-	5.5	V
C10	Input voltage (Low)	V_{IL3}		0	-	$0.2 \times V_{DD2}$	V
C11	Input leakage current	I_{LK3}		-20	0.04	+20	μA

Input/Output Pin: TX3V

C12	Input voltage (High)	V_{IH4}		$0.7 \times V_{DD2}$	-	V_{DD2}	V
C13	Input voltage (Low)	V_{IL4}		0	-	$0.3 \times V_{DD2}$	V
C14	Output leakage current	I_{LK4}		-10	0.02	+10	μA
C15	Output voltage (Low)	V_{OL4}	$V_{DD2} = 3.3\text{ V}, I_{OL} = 4.0\text{ mA}$	-	-	0.4	V

Input/Output Pin: TX5V (5 V Tolerant)

C16	Input voltage (High)	V_{IH5}		$0.6 \times V_{DD2}$	-	5.5	V
C17	Input voltage (Low)	V_{IL5}		0	-	$0.2 \times V_{DD2}$	V
C18	Output leakage current	I_{LK5}		-20	0.04	+20	μA
C19	Output voltage (Low)	V_{OL5}	$V_{DD2} = 3.3\text{ V}, I_{OL} = 4.0\text{ mA}$	-	-	0.4	V

Output Pin: IRQ3V

C20	Output leakage current	I_{LK6}		-10	0.02	+10	μA
C21	Output voltage (Low)	V_{OL6}	$V_{DD2} = 3.3\text{ V}, I_{OL} = 4.0\text{ mA}$	-	-	0.4	V

Output Pin: IRQ5V (5 V Tolerant)

C22	Output leakage current	I_{LK7}		-20	0.04	+20	μA
C23	Output voltage (Low)	V_{OL7}	$V_{DD2} = 3.3\text{ V}, I_{OL} = 4.0\text{ mA}$	-	-	0.4	V

Reference Information

In our evaluation, 3.3-k Ω (reference value) pullup resistors are connected to the open-drain pins TX3V, TX5V, IRQ3V and IRQ5V. Determine the value of pullup resistors based on data rate, load capacitance, and other factors.

Input Capacitance

$V_{SS} = 0\text{ V}$

Parameter		Symbol	Conditions	Limits			Unit
				Min	Typ	Max	
C24	Input capacitance between antenna coil connection pins (VA and VB)	C_i	$T_a = 25^\circ\text{C}$ 13.56 MHz, amplitude (RMS) 1 V, bias 2 V	15.5	17.5	19.5	pF

Load Switch

$T_a = -20^\circ\text{C}$ to 85°C , $V_{SS} = 0\text{ V}$

Parameter		Symbol	Conditions	Limits			Unit
				Min	Typ	Max	
C25	Load switch resistance	R_{LD}	Between VA and VB pins	90	150	210	Ω

Clamp Circuit

$T_a = -20^\circ\text{C}$ to 85°C , $V_{SS} = 0\text{ V}$

Parameter		Symbol	Conditions	Limits			Unit
				Min	Typ	Max	
C26	Clamp voltage for VDD2	V_{CLP}	See condition 1) on page 4.	-	-	3.6	V

D. AC Characteristics

Serial Interface (UART)

Ta = -20°C to 85°C, V_{SS} = 0 V

Parameter	Symbol	Conditions	Limits			Unit
			Min	Typ	Max	
D1 RX rise time	t _{RRX}		-	-	t _{DRX} × 0.025	s
D2 RX fall time	t _{FRX}		-	-	t _{DRX} × 0.025	s
D3 TX 1-bit data period	t _{DTX}		t _{DTX} × 0.975	-	t _{DRX} × 1.025	s

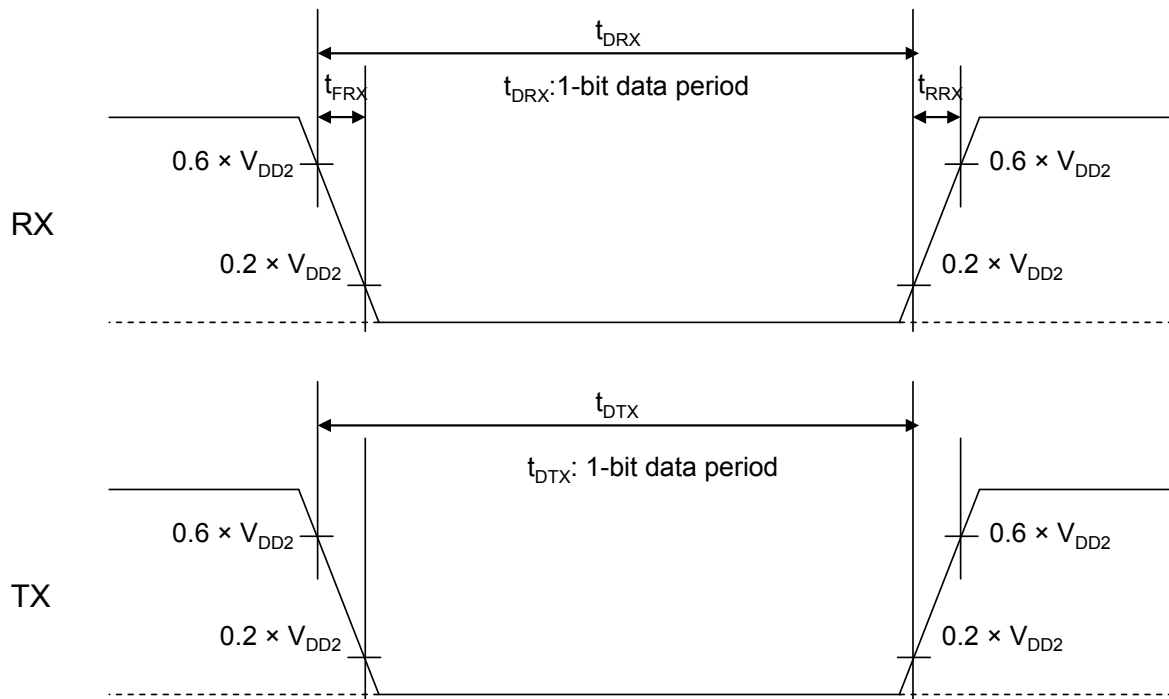

Fig. 3

Serial Interface (Clock Synchronous)

Ta = -20°C to 85°C, V_{SS} = 0 V

Parameter	Symbol	Conditions	Limits			Unit
			Min	Typ	Max	
D4	Clock frequency	f _{SCK}	0.01	-	1	MHz
D5	Receive data setup time	t _{RXDS}	100	-	-	ns
D6	Receive data hold time	t _{RXDH}	100	-	-	ns
D7	Transmit data setup time	t _{TXDS}	100	-	-	ns
D8	Transmit data hold time	t _{TXDH}	100	-	-	ns

■ Data Reception

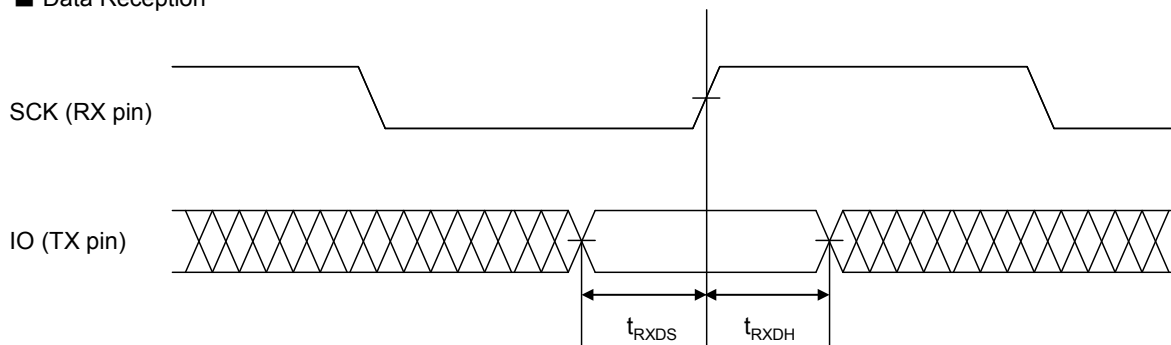

■ Data Transmission

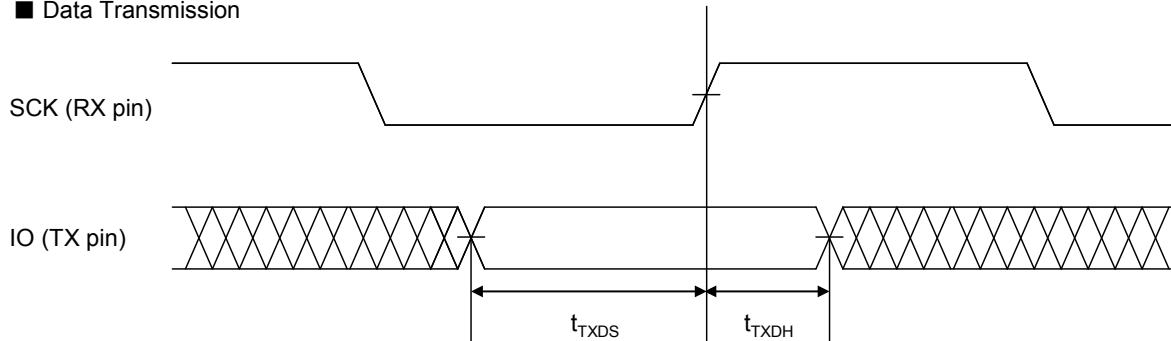

Fig. 4

RF Interface

Ta = -20°C to 85°C, V_{SS} = 0 V

Parameter		Symbol	Conditions	Limits			Unit
				Min	Typ	Max	
D9	VB pin voltage (Peak to peak, RF = High, VDD2: Not applied)	V _{RFH1}	The frequency of the antenna coil connection pins: 13.56 MHz	4.5	-	21	V
D10	VB pin voltage (Peak to peak, RF = High, VDD2: Applied)	V _{RFH2}	The frequency of the antenna coil connection pins: 13.56 MHz	3.5	-	21	V
D11	Modulation factor for command reception	m	JISX6319-4 standards: Data rate of 212 kbps Output waveform with independent reader/writer	4.0	-	14	%

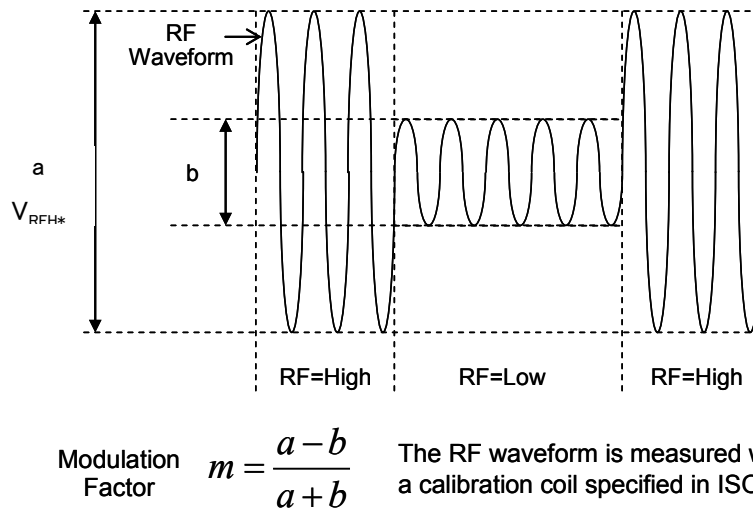

Fig. 5

E. Power Supply Startup

Ta = -20°C to 85°C, V_{SS} = 0 V

Parameter	Symbol	Conditions	Limits			Unit
			Min	Typ	Max	
E1	Startup time for VEXT power supply	t _{BOOT1} VEXT = 4.5 V to 5.5 V See note 6)	-	-	5	ms
E2	Startup time for VEXT power supply	t _{BOOT2} VEXT = 1.8 V to 3.6 V See note 7)	-	-	3	ms
E3	Pulse width for VEXT power supply	t _{PLW1} VEXT = 4.5 V to 5.5 V See note 6)	5	-	-	ms
E4	Pulse width for VEXT power supply	t _{PLW2} VEXT = 1.8 V to 3.6 V See note 7)	3	-	-	ms
E5	Rise time for VEXT power supply	t _{SLW1} VEXT = 4.5 V to 5.5 V See note 6)	0.1	-	-	ms
E6	Rise time for VEXT power supply	t _{SLW2} VEXT = 1.8 V to 3.6 V See note 7)	0.1	-	-	ms

Note 7) Smooth capacitor between VDD2 and VSS: 0.1 μF, Smooth capacitor between VDD and VSS: 0.1 μF
Resistor between VEXT and VDD2: 5.1 kΩ

Note 8) Smooth capacitor between VDD2 and VSS: 0.1 μF, Smooth capacitor between VDD and VSS: 0.1 μF

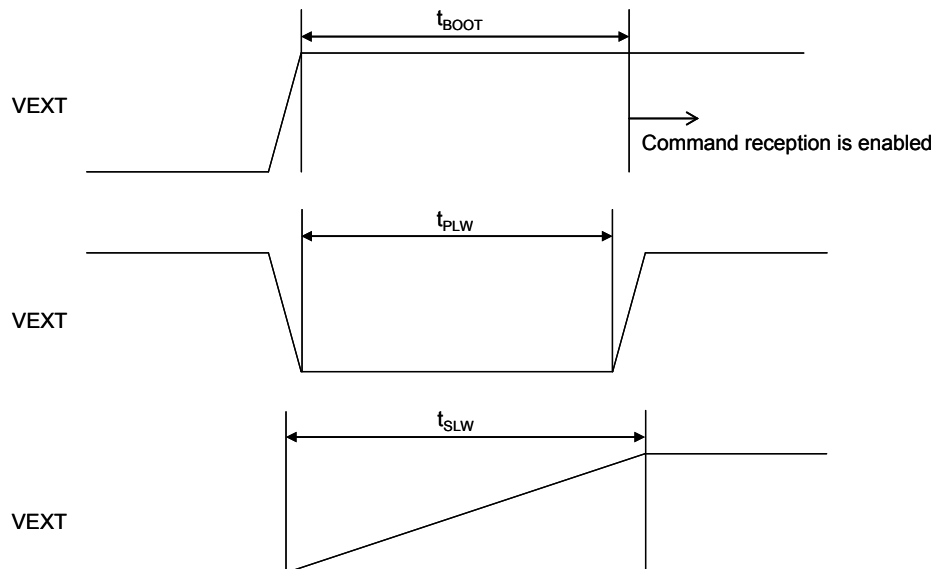

Fig. 6

Revision History

Revised on Jun14, 2013

Purpose	Version 1.0			Version xx		
	Page	Section	Comments	Page	Section	Comments
			Initial edition			

Revised on Oct 08, 2013

Purpose	Version 1.0			Version 1.1		
	Page	Section	Comments	Page	Section	Comments
Modify	P50	Table4-10	Physical adr 0x0001 Value : 0x0F Physical adr 0x0003 to 0x0004 Value : 0x0018	P50	Table4-10	Physical adr 0x0001 Value : 0x0D Physical adr 0x0003 to 0x0004 Value : 0x001A

Revised on Feb 24, 2015

Purpose	Version 1.1			Version 1.2		
	Page	Section	Comments	Page	Section	Comments
Add	---	---	---	P107	---	Chapter 8 Electrical characteristics

Request for your special attention and precautions in using the technical information and semiconductors described in this book

- (1) If any of the products or technical information described in this book is to be exported or provided to non-residents, the laws and regulations of the exporting country, especially, those with regard to security export control, must be observed.
- (2) The technical information described in this book is intended only to show the main characteristics and application circuit examples of the products. No license is granted in and to any intellectual property right or other right owned by Panasonic Corporation, Nuvoton Technology Corporation Japan or any other company. Therefore, no responsibility is assumed by our company as to the infringement upon any such right owned by any other company which may arise as a result of the use of technical information de-scribed in this book.
- (3) The products described in this book are intended to be used for general applications (such as office equipment, communications equipment, measuring instruments and household appliances), or for specific applications as expressly stated in this book.
Please consult with our sales staff in advance for information on the following applications, moreover please exchange documents separately on terms of use etc.: Special applications (such as for in-vehicle equipment, airplanes, aerospace, automotive equipment, traffic signaling equipment, combustion equipment, medical equipment and safety devices) in which exceptional quality and reliability are required, or if the failure or malfunction of the products may directly jeopardize life or harm the human body.
Unless exchanging documents on terms of use etc. in advance, it is to be understood that our company shall not be held responsible for any damage incurred as a result of or in connection with your using the products described in this book for any special application.
- (4) The products and product specifications described in this book are subject to change without notice for modification and/or improvement. At the final stage of your design, purchasing, or use of the products, therefore, ask for the most up-to-date Product Standards in advance to make sure that the latest specifications satisfy your requirements.
- (5) When designing your equipment, comply with the range of absolute maximum rating and the guaranteed operating conditions (operating power supply voltage and operating environment etc.). Especially, please be careful not to exceed the range of absolute maximum rating on the transient state, such as power-on, power-off and mode-switching. Otherwise, we will not be liable for any defect which may arise later in your equipment.
Even when the products are used within the guaranteed values, take into the consideration of incidence of break down and failure mode, possible to occur to semiconductor products. Measures on the systems such as redundant design, arresting the spread of fire or preventing glitch are recommended in order to prevent physical injury, fire, social damages, for example, by using the products.
- (6) Comply with the instructions for use in order to prevent breakdown and characteristics change due to external factors (ESD, EOS, thermal stress and mechanical stress) at the time of handling, mounting or at customer's process. We do not guarantee quality for disassembled products or the product re-mounted after removing from the mounting board.
When using products for which damp-proof packing is required, satisfy the conditions, such as shelf life and the elapsed time since first opening the packages.
- (7) When reselling products described in this book to other companies without our permission and receiving any claim of request from the resale destination, please understand that customers will bear the burden.
- (8) This book may be not reprinted or reproduced whether wholly or partially, without the prior written permission of our company.

No.070920

单击下面可查看定价，库存，交付和生命周期等信息

[>>Panasonic\(松下\)](#)