

**!** Partly to Be Discontinued  
Last time buy: September 30, 2016

For board-to-board | For board-to-FPC

### Narrow pitch connectors (0.35mm pitch)

# P35S

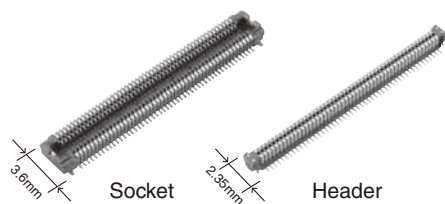

RoHS compliant

### FEATURES

**1. Small size 0.35 mm pitch contributes to device miniaturization.**

Smaller compared to P4S (20 pin contacts):

Socket — 11% smaller,  
Header — 12% smaller

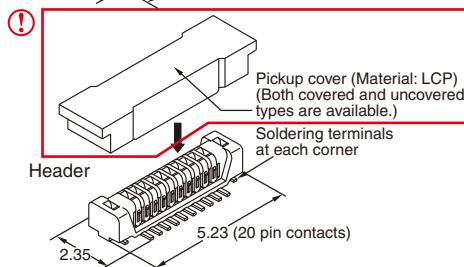
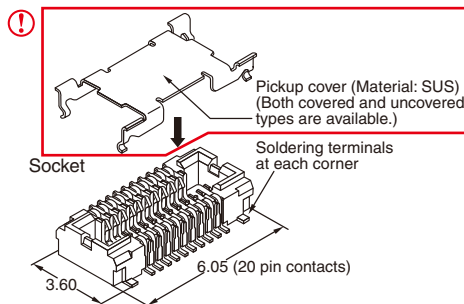

**2. Strong resistance to adverse environments! Utilizes "TOUGH CONTACT" construction for high contact reliability.**

**3. Greater flexibility in connector placement.**

Pattern wiring to the connector bottom is made possible with a molded covering on the undersurface of the connector.

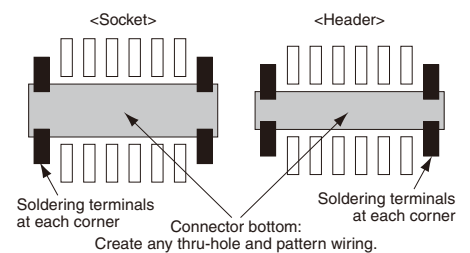

**4. Gull-wing-shaped terminals to facilitate visual inspections.**

**5. Connectors for inspection available**

### APPLICATIONS

Mobile devices, such as cellular phones, digital still cameras and digital video cameras.

### ORDERING INFORMATION

AXT     **1**   **4**

1: Narrow Pitch Connector P35S (0.35 mm pitch) Socket

2: Narrow Pitch Connector P35S (0.35 mm pitch) Header

Number of pins (2 digits)

Mated height

<Socket>/<Header>

1: For mated height 1.5 mm

Functions

<Socket>/<Header>

2: No pickup cover, without positioning bosses

**!** 6: With pickup cover, without positioning bosses

Surface treatment (Contact portion / Terminal portion)

<Socket>

4: Ni plating on base, Au plating on surface (for Ni barrier available)

<Header>

4: Ni plating on base, Au plating on surface

## PRODUCT TYPES

Mated height	Number of pins	Part number		Packing	
		Socket	Header	Inner carton	Outer carton
1.5mm	20	AXT120124	AXT220124	3,000 pieces	6,000 pieces
	22	AXT122124	AXT222124		
	24	AXT124124	AXT224124		
	26	AXT126124	AXT226124		
	28	AXT128124	AXT228124		
	30	AXT130124	AXT230124		
	32	AXT132124	AXT232124		
	34	AXT134124	AXT234124		
	36	AXT136124	AXT236124		
	38	AXT138124	AXT238124		
	40	AXT140124	AXT240124		
	50	AXT150124	AXT250124		
	52	AXT152124	AXT252124		
	60	AXT160124	AXT260124		
	70	AXT170124	AXT270124		
	80	AXT180124	AXT280124		
	90	AXT190124	AXT290124		
100	AXT100124	AXT200124			

Notes: 1. Regarding ordering units; During production: Please make orders in 1-reel units.

For samples, please contact our sales office.

2. If you require the pickup cover, change the eighth digit of the part number from "2" to "6" in your order. Note that the pickup cover is not available for some types depending on the number of pins. Check the latest product specifications.
3. The above part numbers are for connectors without positioning bosses, which are standard. When ordering connectors with positioning bosses, please contact our sales office.

## SPECIFICATIONS

### 1. Characteristics

	Item	Specifications	Conditions																
Electrical characteristics	Rated current	0.25A/pin contact (Max. 4 A at total pin contacts)	—																
	Rated voltage	60V AC/DC	—																
	Breakdown voltage	150V AC for 1 min.	Rated voltage is applied for one minute and check for short circuit or damage with a detection current of 1mA.																
	Insulation resistance	Min. 1,000M $\Omega$ (initial)	Using 250V DC megger (applied for 1 min.)																
	Contact resistance	Max. 100m $\Omega$	Based on the contact resistance measurement method specified by JIS C 5402.																
Mechanical characteristics	Composite insertion force	Max. 0.981N/pin contacts $\times$ pin contacts (initial)																	
	Composite removal force	Min. 0.0588N/pin contacts $\times$ pin contacts																	
	Contact holding force (Socket contact)	Min. 0.981N/pin contacts	Measuring the maximum force. As the contact is axially pull out.																
Environmental characteristics	Ambient temperature	-55°C to +85°C	No freezing at low temperatures																
	Soldering heat resistance	Max. peak temperature of 260°C (on the surface of the PC board around the connector terminals)	Infrared reflow soldering																
		300°C within 5 sec. or 350°C within 3 sec.	Soldering iron																
	Storage temperature	-55°C to +85°C (product only) -40°C to +50°C (emboss packing)	No freezing at low temperatures																
	Thermal shock resistance (header and socket mated)	5 cycles, insulation resistance min. 100M $\Omega$ , contact resistance max. 100m $\Omega$	Conformed to MIL-STD-202F, method 107G																
			<table border="1"> <thead> <tr> <th>Order</th> <th>Temperature (°C)</th> <th>Time (minutes)</th> </tr> </thead> <tbody> <tr> <td>1</td> <td>-55<math>\frac{3}{3}</math></td> <td>30</td> </tr> <tr> <td>2</td> <td>∩</td> <td>Max. 5</td> </tr> <tr> <td>3</td> <td>85<math>\frac{3}{3}</math></td> <td>30</td> </tr> <tr> <td>4</td> <td>∩</td> <td>Max. 5</td> </tr> <tr> <td></td> <td>-55<math>\frac{3}{3}</math></td> <td></td> </tr> </tbody> </table>	Order	Temperature (°C)	Time (minutes)	1	-55 $\frac{3}{3}$	30	2	∩	Max. 5	3	85 $\frac{3}{3}$	30	4	∩	Max. 5	
	Order	Temperature (°C)	Time (minutes)																
1	-55 $\frac{3}{3}$	30																	
2	∩	Max. 5																	
3	85 $\frac{3}{3}$	30																	
4	∩	Max. 5																	
	-55 $\frac{3}{3}$																		
Humidity resistance (header and socket mated)	120 hours, insulation resistance min. 100M $\Omega$ , contact resistance max. 100m $\Omega$	Conformed to IEC60068-2-78 Temperature 40 $\pm$ 2°C, humidity 90 to 95% R.H.																	
Saltwater spray resistance (header and socket mated)	24 hours, insulation resistance min. 100M $\Omega$ , contact resistance max. 100m $\Omega$	Conformed to IEC60068-2-11 Temperature 35 $\pm$ 2°C, saltwater concentration 5 $\pm$ 1%																	
H <sub>2</sub> S resistance (header and socket mated)	48 hours, contact resistance max. 100m $\Omega$	Temperature 40 $\pm$ 2°C, gas concentration 3 $\pm$ 1 ppm, humidity 75 to 80% R.H.																	
Lifetime characteristics	Insertion and removal life	50 times	Repeated insertion and removal speed of max. 200 times/hours																
Unit weight		50 pin contact type: Socket: 0.06 g Header: 0.03 g																	

### 2. Material and surface treatment

Part name	Material	Surface treatment
Molded portion	LCP resin (UL94V-0)	—
Contact and Post	Copper alloy	Contact portion: Ni plating on base, Au plating on surface Terminal portion: Ni plating on base, Au plating on surface (Except for front edge of terminal) However, the area adjacent to the socket terminal is exposed to Ni on base. Soldering terminals portion; Socket: Ni plating on base, Pd + Au flash plating on surface (Expect for front edge of terminal) Header: Ni plating on base, Au plating on surface (Expect for front edge of terminal)

## DIMENSIONS (Unit: mm)

The CAD data of the products with a **CAD Data** mark can be downloaded from: <http://industrial.panasonic.com/ac/e/>

### 1. Socket (Mated height: 1.5mm)

- Without pickup cover

#### CAD Data

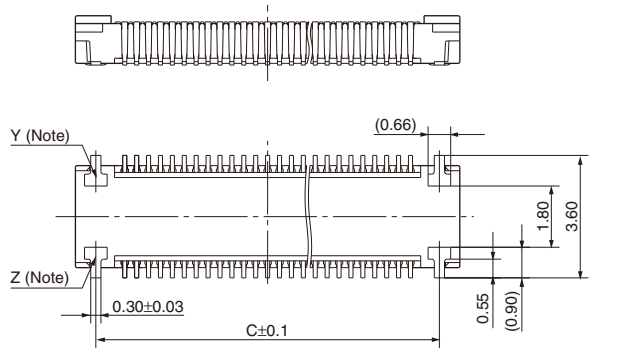
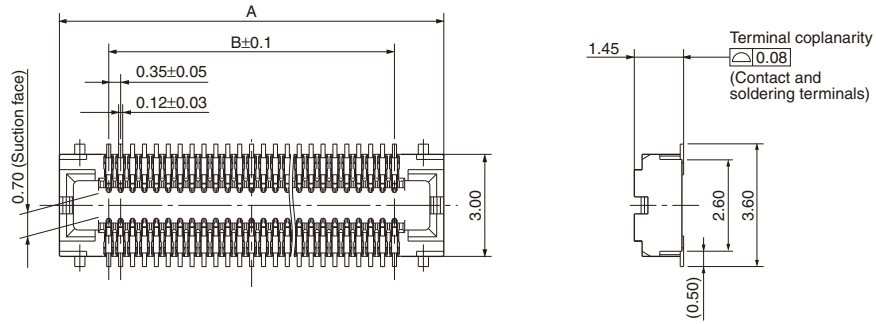

General tolerance:  $\pm 0.2$

Dimension table (mm)

Number of pins/ dimension	A	B	C
20	6.05	3.15	4.85
22	6.40	3.50	5.20
24	6.75	3.85	5.55
26	7.10	4.20	5.90
28	7.45	4.55	6.25
30	7.80	4.90	6.60
32	8.15	5.25	6.95
34	8.50	5.60	7.30
36	8.85	5.95	7.65
38	9.20	6.30	8.00
40	9.55	6.65	8.35
50	11.30	8.40	10.10
52	11.65	8.75	10.45
60	13.05	10.15	11.85
70	14.80	11.90	13.60
80	16.55	13.65	15.35
90	18.30	15.40	17.10
100	20.05	17.15	18.85

- With pickup cover

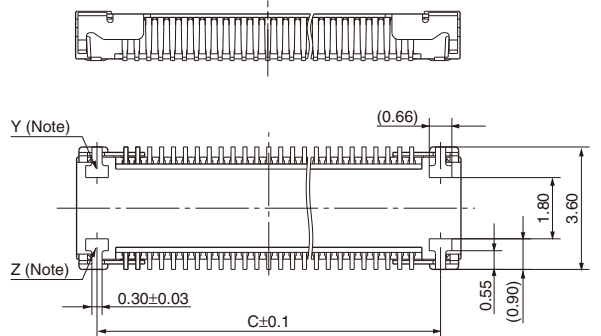
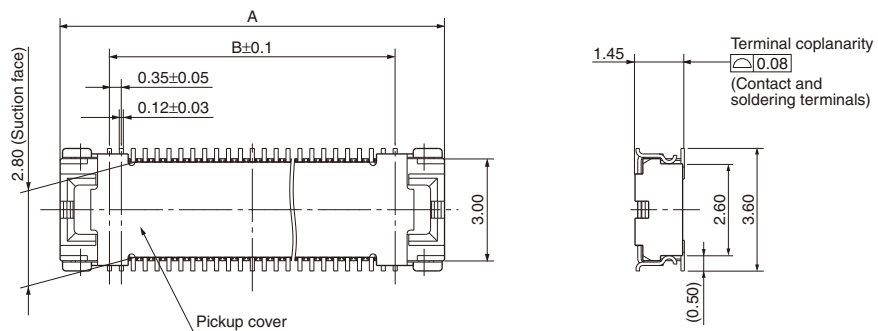

General tolerance:  $\pm 0.2$

Note: Since soldering terminals are built into the body, the Y and Z parts are connected electrically.

2. Header (Mated height: 1.5mm)

- Without pickup cover

CAD Data

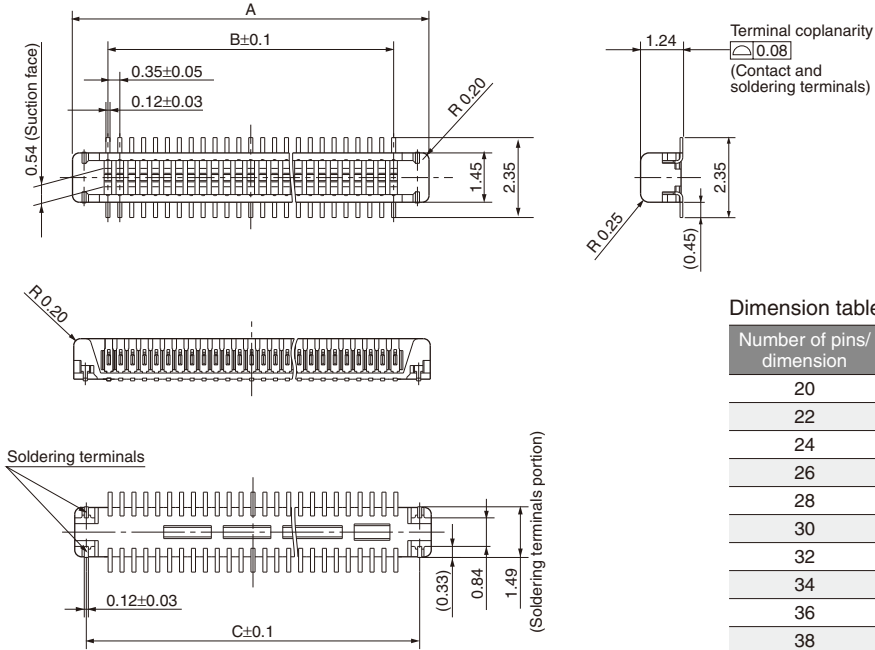

Dimension table (mm)

Number of pins/ dimension	A	B	C
20	5.23	3.15	4.55
22	5.58	3.50	4.90
24	5.93	3.85	5.25
26	6.28	4.20	5.60
28	6.63	4.55	5.95
30	6.98	4.90	6.30
32	7.33	5.25	6.65
34	7.68	5.60	7.00
36	8.03	5.95	7.35
38	8.38	6.30	7.70
40	8.73	6.65	8.05
50	10.48	8.40	9.80
52	10.83	8.75	10.15
60	12.23	10.15	11.55
70	13.98	11.90	13.30
80	15.73	13.65	15.05
90	17.48	15.40	16.80
100	19.23	17.15	18.55

General tolerance: ±0.2

- With pickup cover

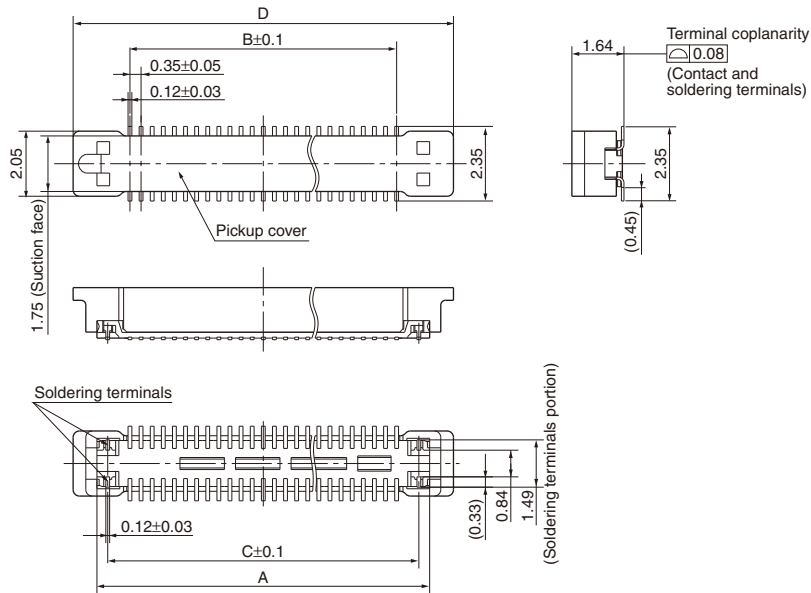

General tolerance: ±0.2

Socket and Header are mated

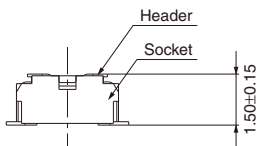

## EMBOSSED TAPE DIMENSIONS (unit: mm, Common for respective contact type, socket and header)

• Tape dimensions (Conforming to JIS C 0806:1990.

• Plastic reel dimensions (Conforming to EIAJ ET-7200B)

However, some tapes have mounting hole pitches that do not comply with the standard.)

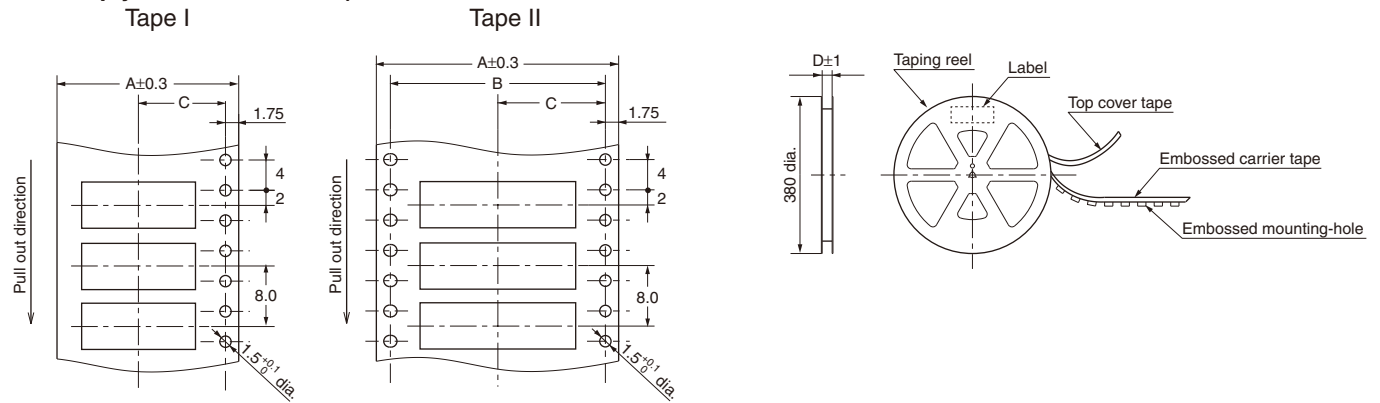

### Dimension table (mm)

Mated height	Number of pins	Type of taping	A	B	C	D	Quantity per reel
Common for socket and header: 1.5mm	Max. 24	Tape I	16.0	—	7.5	17.4	3,000
	26 to 70	Tape I	24.0	—	11.5	25.4	3,000
	72 to 100	Tape II	32.0	28.4	14.2	33.4	3,000

### Connector orientation with respect to direction of progress of embossed tape

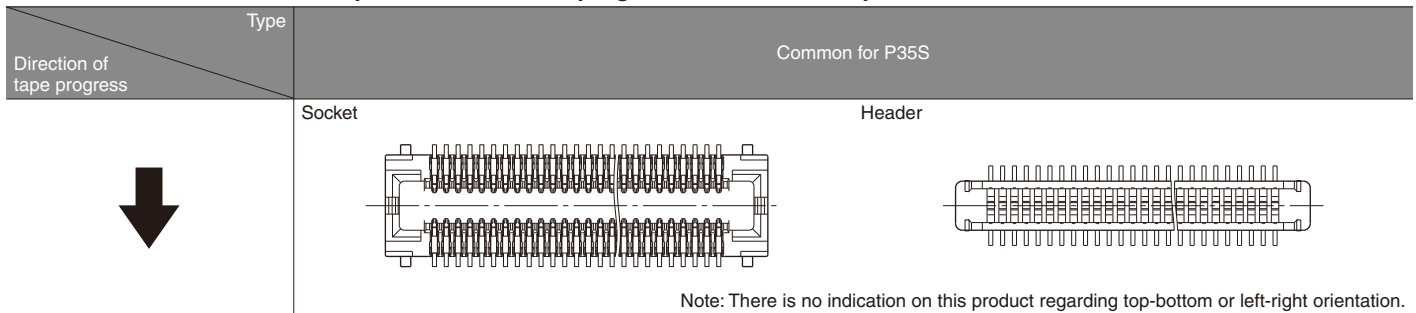

**!** Partly to Be Discontinued  
Last time buy: September 30, 2016

For board-to-board | For board-to-FPC

**Connectors for inspection usage (0.35mm pitch)**

**P35S**

**FEATURES**

- 1. 3,000 mating and unmating cycles
- 2. Same external dimensions and foot pattern as standard type.
- 3. Improved mating

Insertion and removal easy due to a reduction in mating retention force. This is made possible by a simple locking structure design.

Note: Mating retention force cannot be warranted.

**APPLICATIONS**

Ideal for module unit inspection and equipment assembly inspection

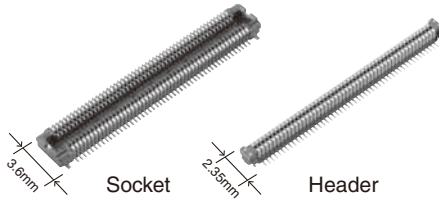

**RoHS compliant**

**TABLE OF PRODUCT TYPES**

☆: Available for sale

Product name	Number of pins																		
	20	22	24	26	28	30	32	34	36	38	40	50	52	60	70	80	90	100	
P35S for inspection	☆	☆	☆	☆	☆	☆	☆	☆	☆	☆	☆	☆	☆	☆	☆	☆	☆	☆	☆

- Notes: 1. The pickup surface shape of the inspection sockets is different from that of the standard sockets. (For details, refer to the product specification diagram.)  
 2. Please inquire number of pins other than those shown above.  
 3. Please inquire us regarding availability.  
 4. Please keep the minimum order quantities no less than 50 pieces per lot.  
 5. Please inquire if further information is needed.

**PRODUCT TYPES**

	Specifications		Part No.	Header	Specifications		Part No.
	Socket	With pickup cover	Without positioning bosses		AXT1E**66	With pickup cover	Without positioning bosses
	No pickup cover	Without positioning bosses	AXT1E**26	No pickup cover	Without positioning bosses	AXT2E**26	

- Notes: 1. When placing an order, substitute the "\*" (asterisk) in the above part number with the number of pins for the specific connector.  
 2. The above part numbers are for connectors without positioning bosses, which are standard. When ordering connectors with positioning bosses, please contact our local sales office.

## NOTES

1. As shown below, excess force during insertion may result in damage to the connector or removal of the solder. Also, to prevent connector damage please confirm the correct position before mating connectors.

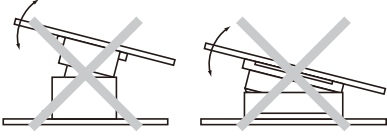

2. Keep the PC board warp no more than 0.03 mm in relation to the overall length of the connector

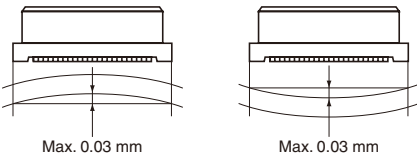

3. If extra resistance to shock caused by dropping is required, we recommend using P4.

4. Recommended PC board and metal mask patterns

Connectors are mounted with high pitch density, intervals of 0.35 mm, 0.4 mm or 0.5 mm.

In order to reduce solder and flux rise, solder bridges and other issues make sure the proper levels of solder is used. The figures to the right are recommended metal mask patterns. Please use them as a reference.

### Socket (Mated height: 1.5mm) Recommended PC board pattern (TOP VIEW)

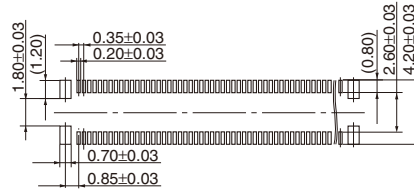

Recommended metal mask pattern  
Metal mask thickness: When 120 μm  
(Terminal portion opening area ratio: 60%)  
(Metal portion opening area ratio: 100%)

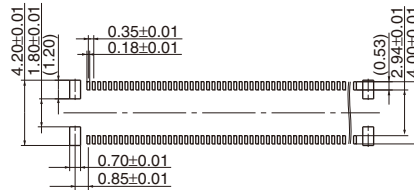

### Header (Mated height: 1.5mm) Recommended PC board pattern (TOP VIEW)

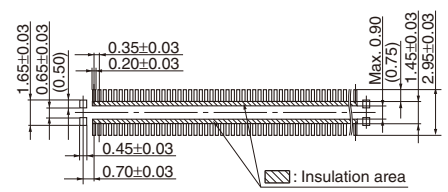

Recommended metal mask pattern  
Metal mask thickness: When 120 μm  
(Terminal portion opening area ratio: 60%)  
(Metal portion opening area ratio: 100%)

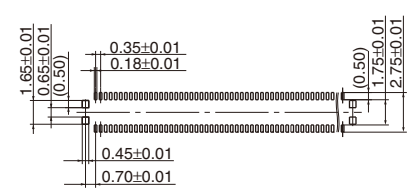

Please refer to the latest product specifications when designing your product.



For board-to-board/board-to-FPC

# Notes on Using Narrow pitch Connectors/ Stacking Connectors for High Current

## About safety remarks

Observe the following safety precautions to prevent accidents and injuries.

- 1) Do not use these connectors beyond the specified ranges. The use of the product outside of the specified rated current and breakdown voltage ranges may cause abnormal heating, smoke, and fire.
- 2) In order to avoid accidents, make sure you have thoroughly reviewed the specifications and the operation manual before use. Please consult us if you plan to use the product in a way not covered

by the specifications. Otherwise, the quality cannot be guaranteed.

- 3) We are consistently striving to improve quality and reliability. However, the fact remains that electrical components and devices generally cause failures at a given statistical probability. Furthermore, their durability varies with use environments or use conditions. In this respect, we ask you to check for actual electrical components and devices under actual conditions before use without fail. Continuously using them in a state of

degraded performance may cause deterioration in insulation performance, thus resulting in abnormal heat generation, smoke generation, or firing. We ask you to carry out safety design including redundancy design, design for fire spread prevention, and design for malfunction prevention as well as periodic maintenance so that no accidents resulting in injury or death, fire accidents, or social damage will be caused as a result of our product failure or service life.

## Regarding the design of devices and PC board patterns

- 1) When using the board to board connectors, do not connect a pair of board with multiple connectors. Otherwise, misaligned connector positions may cause mating failure or product breakage.
- 2) With mounting equipment, there may be up to a  $\pm 0.2$  to 0.3-mm error in positioning. Be sure to design PC boards and patterns while taking into consideration the performance and abilities of the required equipment.
- 3) Some connectors have tabs embossed on the body to aid in positioning. When using these connectors, make sure that the PC board is designed with positioning holes to match these tabs.
- 4) To ensure the required mechanical strength when soldering the connector terminals, make sure the PC board meets recommended PC board pattern design dimensions given.
- 5) PC board  
Control the thicknesses of the coverlay and adhesive to prevent poor soldering. This connector has no stand-off. Therefore, minimize the thickness of the

coverlay, etc. so as to prevent the occurrence of poor soldering.

- 6) For all connectors of the narrow pitch series, to prevent the PC board from coming off during vibrations or impacts, and to prevent loads from falling directly on the soldered portions, be sure to design some means to fix the PC board in place.

### Example) Secure in place with screws

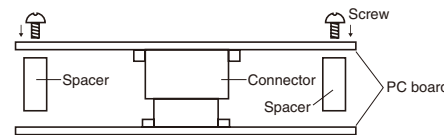

When connecting PC boards, take appropriate measures to prevent the connector from coming off.

- 7) Notes when using a FPC.
  - Due to its flexibility, a FPC board may make the connector terminal soldering connection weak.

In order to strengthen the connection and prevent the peeling off of terminal soldering, a stiffener is strongly recommended to be attached to the

backside of the connector area. The size of stiffener should be bigger than the recommended PC board pattern area shown in the drawing. (Outward dimension + approximate 0.5 to 1.0 mm) Recommended material of reinforcement is Glass-Fiber board, Polyimide board (0.2 to 0.3 mm thickness) or SUS (0.1 to 0.2 mm thickness) which have 0.2 to 0.3 mm thickness.

- Connector would be taken off due to size, weight or bending force of FPC at dropping condition. Please check the connector not to be taken off at real equipment.
- In order to secure connector's connection even when a shock applied, please take measures against taking off of the connector.
- 8) The narrow pitch connector series is designed to be compact and thin. Although ease of handling has been taken into account, take care when mating the connectors, as displacement or angled mating could damage or deform the connector.

## Regarding the selection of the connector placement machine and the mounting procedures

- 1) Select the placement machine taking into consideration the connector height, required positioning accuracy, and packaging conditions.
- 2) Be aware that if the catching force of the placement machine is too great, it may deform the shape of the connector body or connector terminals.

- 3) Be aware that during mounting, external forces may be applied to the connector contact surfaces and terminals and cause deformations.
- 4) Depending on the size of the connector being used, self alignment may not be possible. In such cases, be sure to carefully position the terminal with the PC board pattern.

- 5) The positioning bosses give an approximate alignment for positioning on the PC board. For accurate positioning of the connector when mounting it to the PC board, we recommend using an automatic positioning machine.
- 6) Excessive moulder chucking force may deform the molded or metal part of the connector. Consult us in advance if chucking is to be applied.



## Regarding soldering

### ■ Reflow soldering

- 1) Measure the recommended profile temperature for reflow soldering by placing a sensor on the PC board near the connector surface or terminals. (Please refer to the specification for detail because the temperature setting differs by products.)
- 2) As for cream solder printing, screen printing is recommended.
- 3) When setting the screen opening area and PC board foot pattern area, refer the recommended PC board pattern and window size of metal mask on the specification sheet, and make sure that the size of board pattern and metal mask at the base of the terminals are not increased.
- 4) Please pay attentions not to provide too much solder. It makes miss mating because of interference at soldering portion when mating.

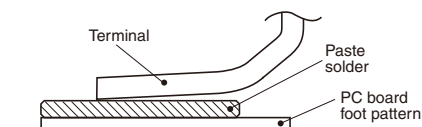

- 5) When mounting on both sides of the PC board and the connector is mounting on the underside, use adhesives or other means to ensure the connector is properly fixed to the PC board. (Double reflow soldering on the same side is possible.)
- 6) The condition of solder or flux rise and wettability varies depending on the type of solder and flux. Solder and flux characteristics should be taken into consideration and also set the reflow temperature and oxygen level.
- 7) Do not use resin-containing solder. Otherwise, the contacts might be firmly fixed.

### • Soldering conditions

Please use the reflow temperature profile conditions recommended below for reflow soldering. Please contact us before using a temperature profile other than that described below (e.g. lead-free solder).

### • Narrow pitch connectors (except P8 type)

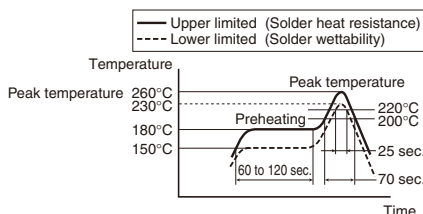

### • Narrow pitch connector (P8)

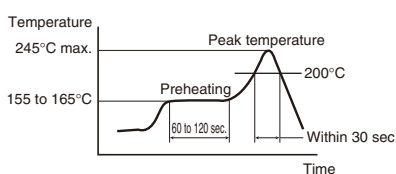

For products other than the ones above, please refer to the latest product specifications.

- 8) The temperature profiles given in this catalog are values measured when using the connector on a resin-based PC board. When performed reflow soldering on a metal board (iron, aluminum, etc.) or a metal table to mount on a FPC, make sure there is no deformation or discoloration of the connector before mounting.
- 9) Consult us when using a screen-printing thickness other than that recommended.

### ■ Hand soldering

- 1) Set the soldering iron so that the tip temperature is less than that given in the table below.

Table A

Product name	Soldering iron temperature
SMD type connectors	300°C within 5 sec. 350°C within 3 sec.

- 2) Do not allow flux to spread onto the connector leads or PC board. This may lead to flux rising up to the connector inside.
- 3) Touch the soldering iron to the foot pattern. After the foot pattern and connector terminal are heated, apply the solder wire so it melts at the end of the connector terminals.

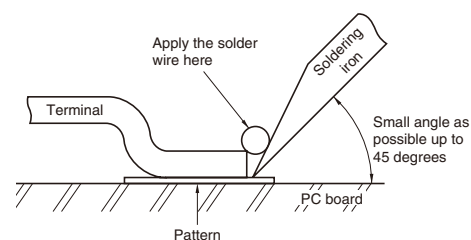

- 4) Be aware that soldering while applying a load on the connector terminals may cause improper operation of the connector.
- 5) Thoroughly clean the soldering iron.
- 6) Flux from the solder wire may get on the contact surfaces during soldering operations. After soldering, carefully check the contact surfaces and clean off any solder before use.
- 7) These connector is low profile type. If too much solder is supplied for hand soldering, It makes miss mating because of interference at soldering portion. Please pay attentions.

### ■ Solder reworking

- 1) Finish reworking in one operation.
- 2) In case of soldering rework of bridges. Don't use supplementary solder flux. Doing so may cause contact problems by flux.
- 3) Keep the soldering iron tip temperature below the temperature given in Table A.

## Handling Single Components

- 1) Make sure not to drop or allow parts to fall from work bench.
- 2) Excessive force applied to the terminals could cause warping, come out, or weaken the adhesive strength of the solder. Handle with care.
- 3) Do not insert or remove the connector when it is not soldered. Forcibly applied external pressure on the terminals can weaken the adherence of the terminals to the molded part or cause the terminals to lose their evenness.

## Precautions for mating

This product is designed with ease of handling. However, in order to prevent the deformation or damage of contacts and molding, take care and do not mate the connectors as shown right.

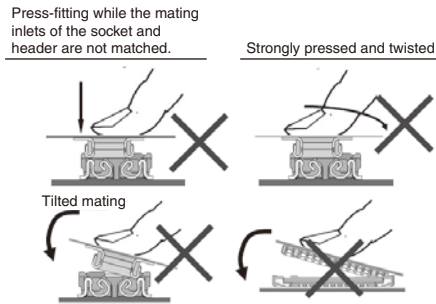

## Cleaning flux from PC board

There is no need to clean this product. If cleaning it, pay attention to the following points to prevent the negative effect to the product.

1) Keep the cleaning solvent clean and prevent the connector contacts from contamination.

2) Some cleaning solvents are strong and they may dissolve the molded part and characters, so pure water passed liquid solvent is recommended.

## Handling the PC board

### ■ Handling the PC board after mounting the connector

When cutting or bending the PC board after mounting the connector, be careful that the soldered sections are subjected to excessive force.

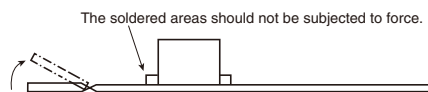

## Storage of connectors

1) To prevent problems from voids or air pockets due to heat of reflow soldering, avoid storing the connectors in areas of high humidity.

2) Depending on the connector type, the color of the connector may vary from connector to connector depending on when it is produced.

Some connectors may change color slightly if subjected to ultraviolet rays during storage. This is normal and will not affect the operation of the connector.

3) When storing the connectors with the PC boards assembled and components already set, be careful not to stack them up so the connectors are subjected to

excessive forces.

4) Avoid storing the connectors in locations with excessive dust. The dust may accumulate and cause improper connections at the contact surfaces.

## Other Notes

1) Do not remove or insert the electrified connector (in the state of carrying current or applying voltage).

2) Dropping of the products or rough mishandling may bend or damage the terminals and possibly hinder proper reflow soldering.

3) Before soldering, try not to insert or remove the connector more than absolutely necessary.

4) When coating the PC board after soldering the connector to prevent the deterioration of insulation, perform the coating in such a way so that the coating does not get on the connector.

5) There may be variations in the colors of products from different production lots. This is normal.

6) The connectors are not meant to be used for switching.

7) Product failures due to condensation are not covered by warranty.

## Regarding sample orders to confirm proper mounting

When ordering samples to confirm proper mounting with the placement machine, connectors are delivered in 50-piece units in the condition given right. Consult a sales representative for ordering sample units.

Condition when delivered from manufacturing



Embossed tape amount required for the mounting

Required number of products for sample production (Unit 50 pcs.)

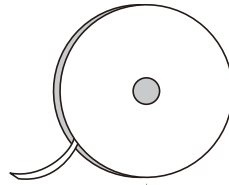

Reel

(Delivery can also be made on a reel by customer request.)

Please refer to the latest product specifications when designing your product.

单击下面可查看定价，库存，交付和生命周期等信息

[>>Panasonic\(松下\)](#)