

High precision  
pressure sensor  
(without amp.)

PS/PF PRESSURE  
SENSOR

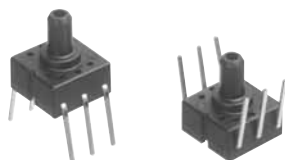

PS pressure sensor

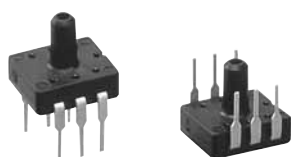

PF pressure sensor

RoHS compliant

## FEATURES

1. Ultra-miniature size (for PS pressure sensor)
  2. High-level precision and linearity
  3. Impressive line-up of models
    - Taking their place alongside the standard 5kΩ bridge resistance models are those with a 3.3kΩ resistance which is optimally suited to 5V drive circuits.
    - Economy model (no glass base) gives outstanding value for consumer appliances
- 40 kPa (0.4 kgf/cm<sup>2</sup>) and 49 kPa (0.5 kgf/cm<sup>2</sup>) units are also available.

## TYPICAL APPLICATIONS

(Please evaluate under actual conditions before using.)

- Industrial use (pressure switches and pneumatic devices, etc.)
- Medical use (blood pressure monitors, compressed air pressure measurement, air beds, etc.)
- Other pneumatically operated pressure devices

## ORDERING INFORMATION

ADP

--	--	--	--	--

<Product name>

- 1: PF pressure sensor  
4: PS pressure sensor

<Terminal profile and direction>

- 1: DIP terminal (Direction opposite the pressure inlet direction)



- 2: DIP terminal (Pressure inlet direction)



<Rated pressure>

- 0: 4.9 kPa  
2: 34.3 kPa  
3: 49.0 kPa  
4: 98.1 kPa  
5: 196.1 kPa  
6: 343.2 kPa  
7: 490.3 kPa  
8: 833.6 kPa  
9: 980.7 kPa  
A: 40.0 kPa

<Type>

- 1: Standard type (With glass base)  
2: Economy type (Without glass base)

<Bridge resistance>









- Nil: PF 5kΩ  
0: PS 5kΩ  
3: 3.3kΩ

Note: Some part numbers may not be available depending on the combination.  
Please refer to the Table of Product Types.

# PS (ADP4)/PF (ADP1)

## TYPES

### 1. DIP terminal

Bridge resistance		Part No.							
		PS pressure sensor				PF pressure sensor			
Terminal	Pressure	5kΩ		3.3kΩ		5kΩ		3.3kΩ	
									
		DIP terminal: Direction opposite the pressure inlet direction	DIP terminal: Pressure inlet direction	DIP terminal: Direction opposite the pressure inlet direction	DIP terminal: Pressure inlet direction	DIP terminal: Direction opposite the pressure inlet direction	DIP terminal: Pressure inlet direction	DIP terminal: Direction opposite the pressure inlet direction	DIP terminal: Pressure inlet direction
Standard type (with glass base)	4.9kPa	ADP41010	ADP42010	—	—	ADP1101	ADP1201	—	—
	34.3kPa	ADP41210	ADP42210	—	—	ADP1121	ADP1221	—	—
	49.0kPa	ADP41310	ADP42310	—	—	ADP1131	ADP1231	—	—
	98.1kPa	ADP41410	ADP42410	ADP41413	ADP42413	ADP1141	ADP1241	—	—
	196.1kPa	ADP41510	ADP42510	—	—	ADP1151	ADP1251	—	—
	343.2kPa	ADP41610	ADP42610	—	—	ADP1161	ADP1261	—	—
	490.3kPa	ADP41710	ADP42710	—	—	ADP1171	ADP1271	—	—
	833.6kPa	ADP41810	ADP42810	—	—	ADP1181	ADP1281	—	—
Economy type (without glass base)	40.0kPa	—	—	ADP41A23	ADP42A23	—	—	ADP11A23	ADP12A23

Standard packing: Carton: 100 pcs.; Case: 1,000 pcs.

## RATING

Type	Standard type (With glass base)								Economy type (Without glass base)
Type of pressure	Gauge pressure								
Pressure medium	Air*2								
Rated pressure	Unit: kPa	4.9	34.3 to 343.2	490.3	833.6	980.7	98.1*3	980.7*3	40.0
Max. applied pressure	Twice the rated pressure			1.5 times the rated pressure		Twice the rated pressure	1.5 times the rated pressure	Twice the rated pressure	Twice the rated pressure
Bridge resistance	5000±1000Ω					3300±700Ω		3300±600Ω	
Ambient temperature	-20 to 100°C -4 to 212°F (no freezing or condensation)								-5 to +50°C +23 to +122°F
Storage temperature	-40 to 120°C -40 to 248°F (no freezing or condensation)								-20 to +70°C -4 to +158°F
Standard temperature	25°C 77°F					30°C 86°F		25°C 77°F	
Temperature compensation range	0 to 50°C 32 to 122°F					0 to 60°C 32 to 140°F		5 to 45°C 41 to 113°F	
Drive current (constant current)	1.5 mA DC					1.0 mA DC		1.5 mA DC	
Output span voltage	40±20 mV	100±40 mV				65±25 mV		43.5±22.5 mV	
Offset voltage	±20 mV								±15 mV
Linearity	±0.7%FS	±0.3%FS	±0.5%FS	±0.6%FS		±1.0%FS		±0.3%FS	
Pressure hysteresis	±0.6%FS	±0.2%FS	±0.4%FS			±1.0%FS		±0.7%FS	
Offset voltage-temperature characteristics*4	±15%FS	±5.0%FS				±3.5%FS		±10%FS	
Sensitivity-temperature characteristics*4	±10%FS	±2.5%FS						±1.3%FS	

Notes: \*1. Unless otherwise specified, measurements were taken with a drive current of ±0.01 mA and humidity ranging from 25% to 85%.

\*2. Please consult us if a pressure medium other than air is to be used.

\*3. For PS pressure sensor only

\*4. This is the regulation which applies within the compensation temperature range.

\*5. Please consult us if the intended use involves a negative pressure.

**REFERENCE DATA**

**[PS pressure sensor]**

**1. Characteristics data**

1.-(1) Output characteristics

ADP41913

Drive current: 1.0 mA; temperature: 30°C 86°F

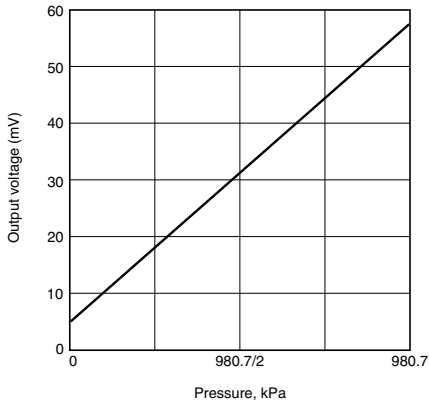

1.-(2) Offset voltage – temperature characteristics

ADP41913

Drive current: 1.0 mA; rating ±3.5%FS

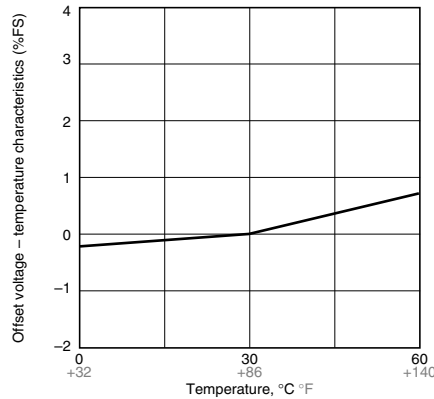

1.-(3) Sensitivity – temperature characteristics

ADP41913

Drive current: 1.0 mA; rating ±2.5%FS

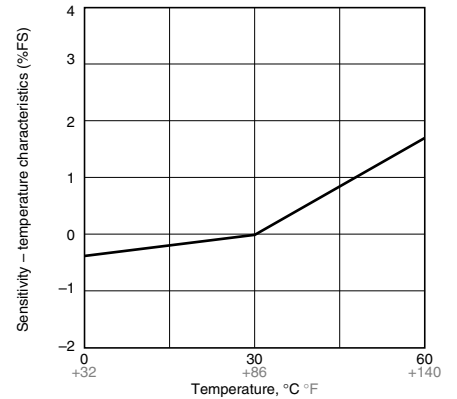

**2. Pressure cycle range (0 to rated pressure)**

Tested sample: ADP41913, temperature: 100°C 212°F, No. of cycle: 1×10<sup>6</sup>

Offset voltage range

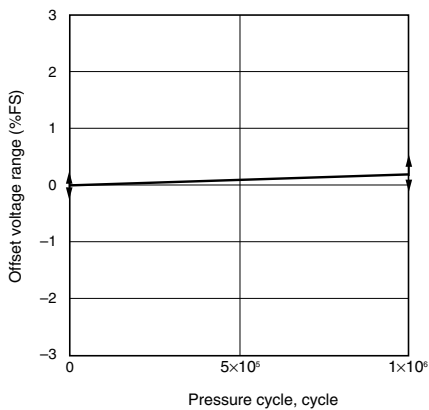

Output span voltage range

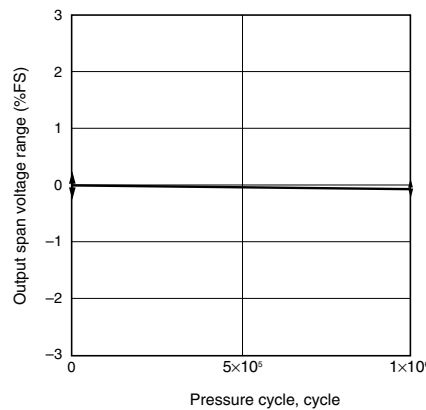

Even after testing for 1 million times, the variations in the offset voltage and output span voltage are minimal.

**[PF pressure sensor]**

**1. Characteristics data**

1.-(1) Output characteristics

ADP1141

Drive current: 1.5 mA; temperature: 25°C 77°F

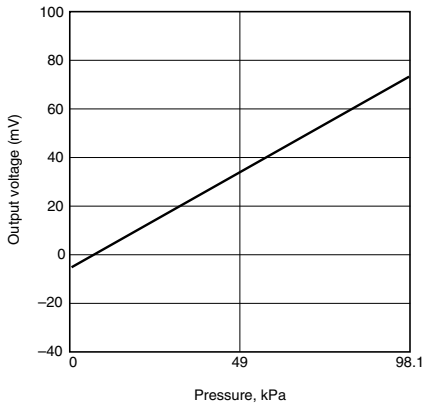

1.-(2) Offset voltage – temperature characteristics

ADP1141

Drive current: 1.5 mA; rating ±5%FS

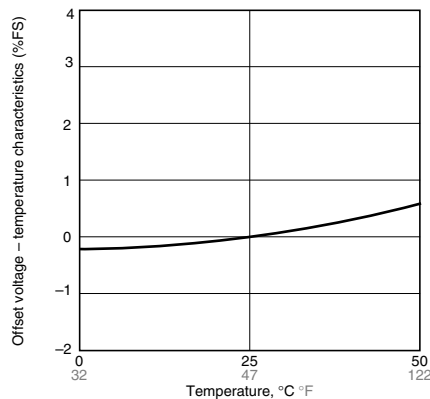

1.-(3) Sensitivity – temperature characteristics

ADP1141

Drive current: 1.5 mA; rating ±2.5%FS

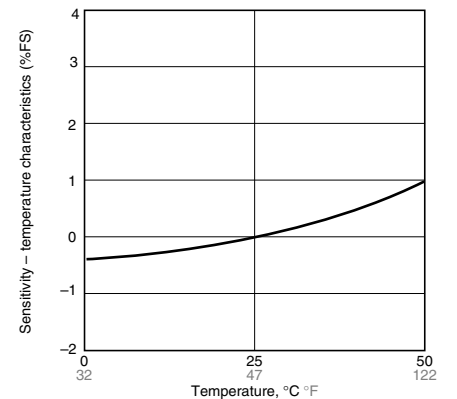

# PS (ADP4)/PF (ADP1)

## 2. Pressure cycle range (0 to rated pressure)

Tested sample: ADP1131, temperature: 25°C 77°F

Offset voltage range

Output span voltage range

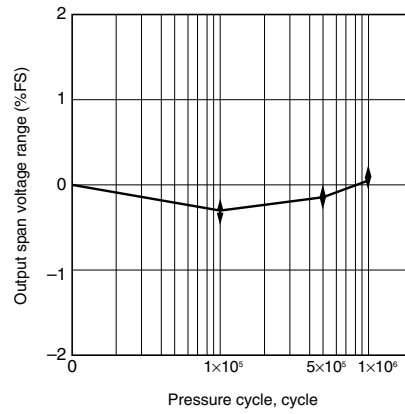
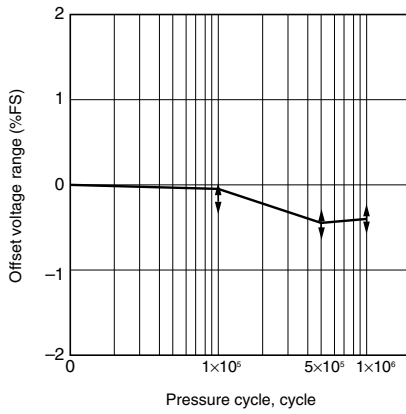

Even after testing for 1 million times, the variations in the offset voltage and output span voltage are minimal.

## Evaluation test

Classification	Tested item	Tested condition	Result
Environmental characteristics	Storage at high temperature	Temperature: Left in a 120°C 248°F constant temperature bath Time: 1,000 hrs.	Passed
	Storage at low temperature	Temperature: Left in a -40°C -40°F constant temperature bath Time: 1,000 hrs.	Passed
	Humidity	Temperature/humidity: Left at 40°C 104°F, 90% RH Time: 1,000 hrs.	Passed
	Temperature cycle	Temperature: -40°C to 120°C -40°F to 248°F 1 cycle: 30 Min. Times of cycle: 100	Passed
Endurance characteristics	High temperature/high humidity operation	Temperature/humidity: 40°C 104°F, 90% RH Operation times: 10 <sup>6</sup> , rated voltage applied	Passed
Mechanical characteristics	Vibration resistance	Double amplitude: 1.5 mm .059 inch Vibration: 10 to 55 Hz Applied vibration direction: X, Y, Z 3 directions Times: 2 hrs each	Passed
	Dropping resistance	Dropping height: 75 cm 29.528 inch Times: 2 times	Passed
	Terminal strength	Pulling strength: 9.8 N {1 kgf}, 10 sec. Bending strength: 4.9 N {0.5 kgf}, left and right 90° 1 time	Passed
Soldering resistance	Soldered in DIP soldering bath	Temperature: 230°C 446°F Time: 5 sec.	Passed
	Temperature	Temperature: 260°C 500°F Time: 10 sec.	Passed

Note: For details other than listed above, please consult us.

## DIMENSIONS (mm inch)

The CAD data of the products with a **CAD Data** mark can be downloaded from: <http://industrial.panasonic.com/ac/e/>

[PS pressure sensor]

1. Terminal direction: DIP terminal Direction opposite the pressure inlet direction ADP41□□□

### CAD Data

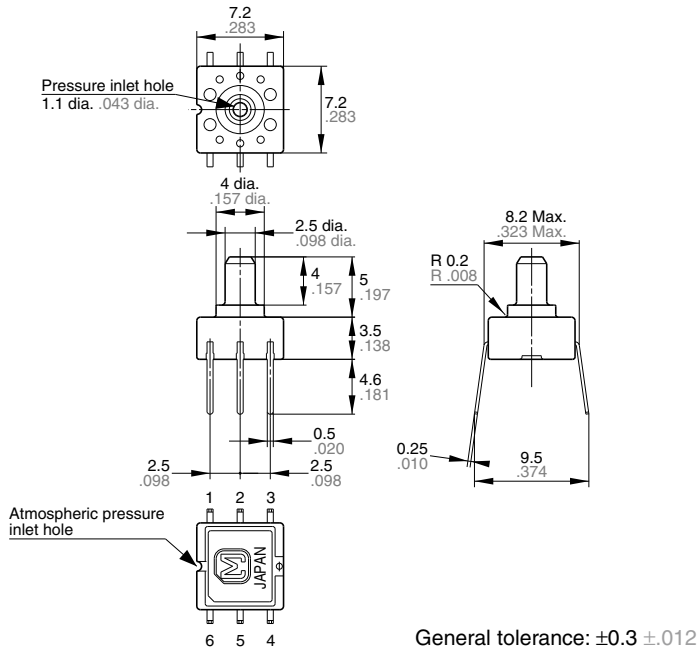

Recommended PC board pattern (BOTTOM VIEW)

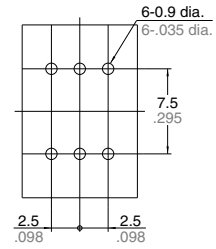

Terminal connection diagram

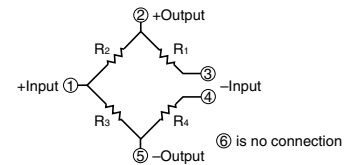

Terminal No.	Name
1	Power supply (+)
2	Output (+)
3	Power supply (-)
4	Power supply (-)
5	Output (-)
6	No connection

Note: Leave terminal 6 unconnected.

2. Terminal direction: DIP terminal Pressure inlet direction ADP42□□□

### CAD Data

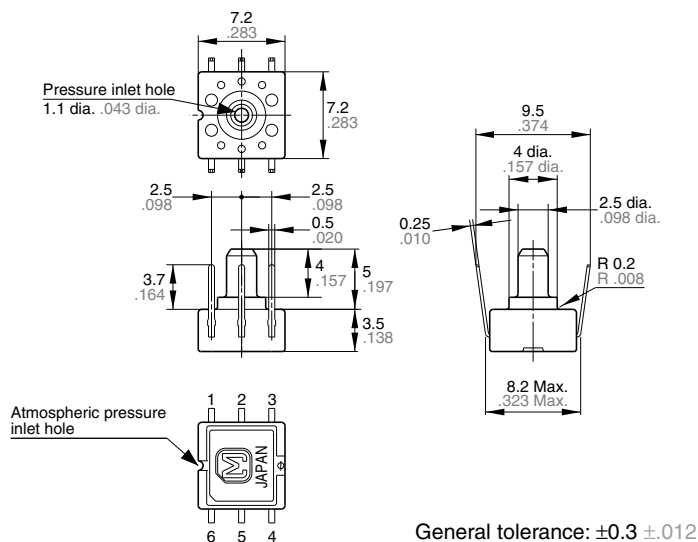

Recommended PC board pattern (BOTTOM VIEW)

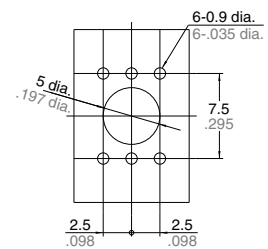

Terminal connection diagram

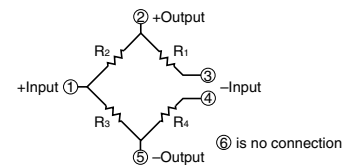

Terminal No.	Name
1	Power supply (+)
2	Output (+)
3	Power supply (-)
4	Power supply (-)
5	Output (-)
6	No connection

Note: Leave terminal 6 unconnected.

# PS (ADP4)/PF (ADP1)

[PF pressure sensor]

1. Terminal direction: Direction opposite the pressure inlet direction ADP11□□ (□)

## CAD Data

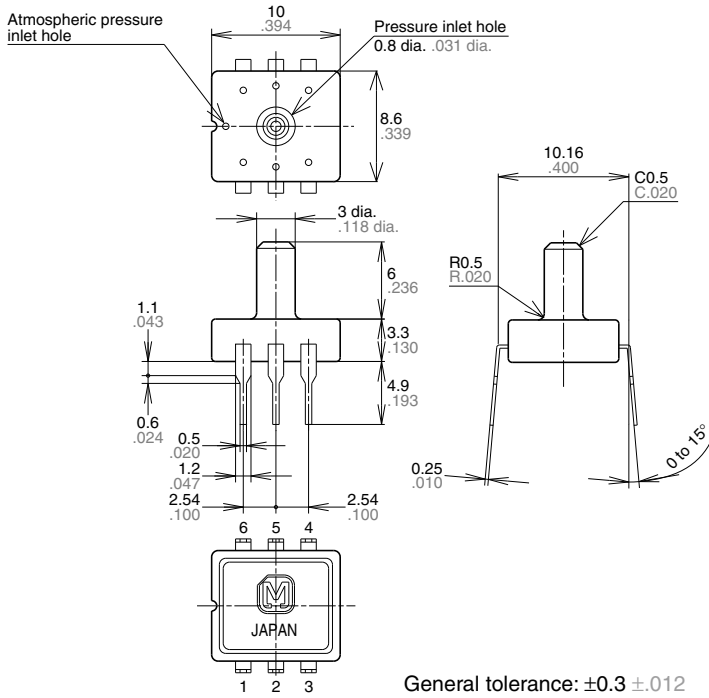

Recommended PC board pattern  
(BOTTOM VIEW)

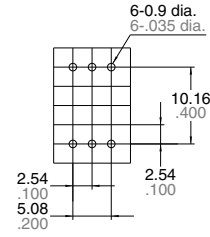

Tolerance:  $\pm 0.1 \pm .004$

Terminal connection diagram

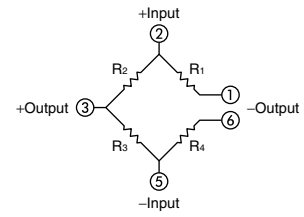

Terminal No.	Name
1	Output (-)
2	Power supply (+)
3	Output (+)
4	No connection
5	Power supply (-)
6	Output (-)

Note: Leave terminal 4 unconnected.

2. Terminal direction: Pressure inlet direction ADP12□□ (□)

## CAD Data

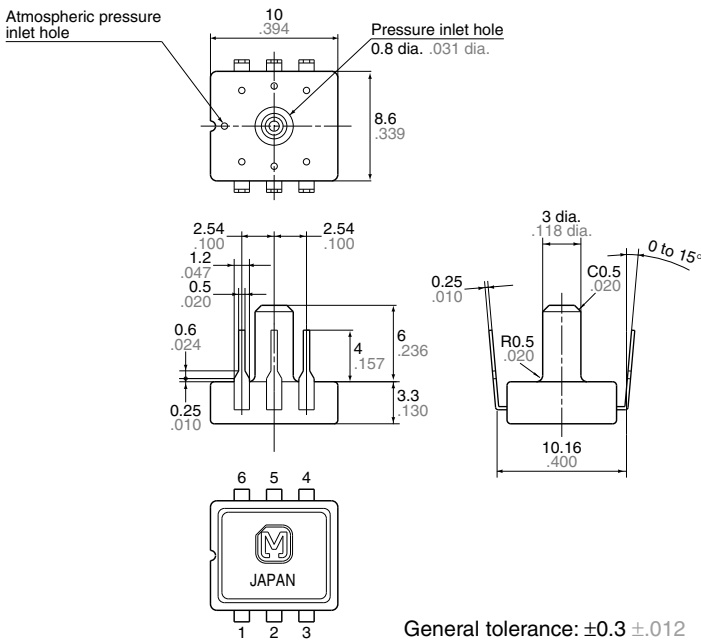

Recommended PC board pattern  
(BOTTOM VIEW)

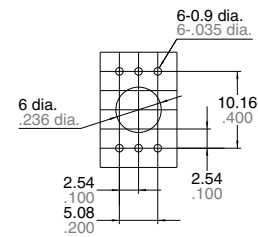

Tolerance:  $\pm 0.1 \pm .004$

Terminal connection diagram

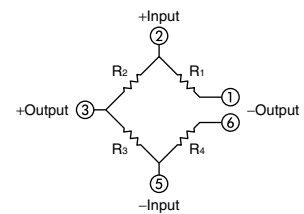

Terminal No.	Name
1	Output (-)
2	Power supply (+)
3	Output (+)
4	No connection
5	Power supply (-)
6	Output (-)

Note: Leave terminal 4 unconnected.

## NOTES

### 1. Mounting

Use lands on the PC boards to which the sensor can be securely fixed.

### 2. Soldering

Due to its small size, the thermal capacity of the pressure sensor DIP type is low. Therefore, take steps to minimize the effects of external heat.

Damage and changes to characteristics may occur due to heat deformation.

Use a non-corrosive resin type of flux. Since the pressure sensor DIP type is exposed to the atmosphere, do not allow flux to enter inside.

#### 1) Manual soldering

- Set the soldering tip from 260 to 300°C 500 to 572°F (30W), and solder for no more than 5 seconds.

- Please note that output may change if the pressure is applied on the terminals when the soldering.

- Thoroughly clean the soldering iron.

#### 2) DIP soldering (DIP terminal type)

- Please keep the DIP solder bath temperature no higher than 260°C 500°F. When soldering, heat should be applied no longer than five seconds.

- When mounting onto a PCB of low thermal capacity, please avoid DIP soldering as this may cause heat deformity.

#### 3) Solder reworking

- Finish reworking in one operation.
- For reworking of the solder bridge, use a soldering iron with a flat tip. Please do not add more flux when reworking.

- Please use a soldering iron that is below the temperature given in the specifications in order to maintain the correct temperature at the tip of the soldering iron.

4) Too much force on the terminals will cause deformation and loss in effectiveness of the solder. Therefore, please avoid dropping and careless handling of the product.

5) Please control warping of the PCB within 0.05 mm of the sensor width.

6) When cut folding the PCB after mounting the sensor, take measures to prevent stress to the soldered parts.

7) The sensor terminals are designed to be exposed, so contact of the terminals with metal shards and the like will cause output errors. Therefore, please be careful and prevent things such as metal shards and hands from contacting the terminals.

8) To prevent degradation of the PCB insulation after soldering, please be careful not to get chemicals on the sensor when coating.

9) Please consult us regarding the use of lead-free solder.

### 3. Cleaning

1) Since the pressure sensor chip is exposed to the atmosphere, do not allow cleaning fluid to enter inside.

2) Avoid ultrasonic cleaning since this may cause breaks or disconnections in the wiring.

### 4. Environment

1) Please avoid using or storing the pressure sensor chip in a place exposed to corrosive gases (such as the gases given off by organic solvents, sulfurous acid gas, hydrogen sulfides, etc.) which will adversely affect the performance of the pressure sensor chip.

2) Since this pressure sensor chip does not have a water-proof construction, please do not use the sensor in a location where it may be sprayed with water, etc.

3) Avoid using the pressure sensors chip in an environment where condensation may form.

Furthermore, its output may fluctuate if any moisture adhering to it freezes.

4) The pressure sensor chip is constructed in such a way that its output will fluctuate when it is exposed to light. Especially when pressure is to be applied by means of a transparent tube, take steps to prevent the pressure sensor chip from being exposed to light.

5) Avoid using the pressure sensor chip where it will be susceptible to ultrasonic or other high-frequency vibration.

### 5. Quality check under actual loading conditions

To assure reliability, check the sensor under actual loading conditions. Avoid any situation that may adversely affect its performance.

### 6. Other handling precautions

1) That using the wrong pressure range or mounting method may result in accidents.

2) The only direct pressure medium you can use is dry air. The use of other media, in particular, corrosive gases (organic solvent based gases, sulfurous acid based gases, and hydrogen sulfide based gases, etc.) and media that contains moisture or foreign substances will cause malfunction and damage. Please do not use them.

3) The pressure sensor chip is positioned inside the pressure inlet. Never poke wires or other foreign matter through the pressure inlet since they may damage the chip or block the inlet. Avoid use when the atmospheric pressure inlet is blocked.

4) Use an operating pressure which is within the rated pressure range. Using a pressure beyond this range may cause damage.

5) Since static charge can damage the pressure sensor chip, bear in mind the following handling precautions.

(1) When storing the pressure sensor chips, use a conductive material to short the pins or wrap the entire chip in aluminum foil. Plastic containers should not be used to store or transport the chips since they readily become charged.

(2) When using the pressure sensor chips, all the charged articles on the bench surface and the work personnel should be grounded so that any ambient static will be safely discharged.

6) Based on the pressure involved, give due consideration to the securing of the pressure sensor DIP type and to the securing and selection of the inlet tube. Consult us if you have any queries.

# PS (ADP4)/PF (ADP1)

## APPLICATION CIRCUIT DIAGRAM (EXAMPLE)

The pressure sensor is designed to convert a voltage by means of constant current drive and then, if necessary, it amplifies the voltage for use. The circuit shown below is a typical example of a circuit in which the pressure sensor is used.

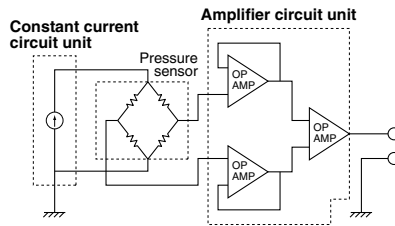

## MOUNTING METHOD

The general method for transmitting air pressures differs depending on whether the pressure is low or high.

### • Checkpoints for use

- (1) Select a pressure inlet pipe which is sturdy enough to prevent pressure leaks.
- (2) Fix the pressure inlet pipe securely so as to prevent pressure leaks.
- (3) Do not block the pressure inlet pipe.

### Methods of transmitting air pressures

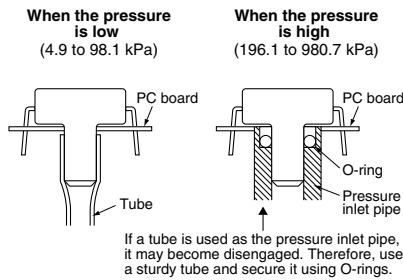



单击下面可查看定价，库存，交付和生命周期等信息

[>>Panasonic\(松下\)](#)