

PV310

Advanced Ultra High-Speed Imagechecker

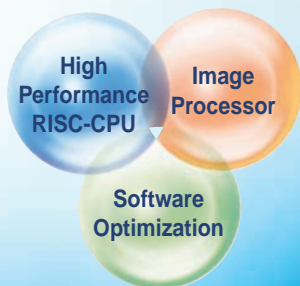



The PV310 achieves ultra high-speed image processing by:

- utilizing two processors
(image processor + high-performance RISC CPU)
- optimizing its software
(unique, high-speed image processing algorithm)

Excellent Peripheral Functions of the PV310

Ultra-Compact Camera (12 mm diameter)

Ultra-compact camera have been added to the conventional variety of cameras already supported. This facilitates miniaturizing target equipment and retrofitting cameras in narrower spaces.

New Function

Branch Execution/Designated Execution

Change inspection routines immediately! Tooling changes are a thing of the past!

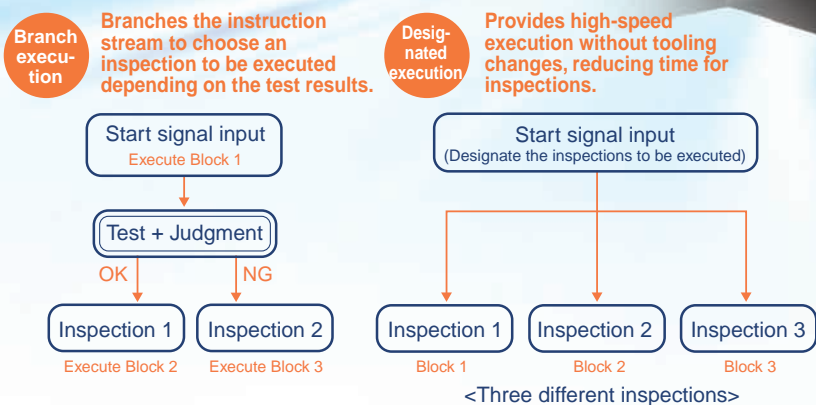

New Function

Image Data Transfer and Storage When Running

Image data can be saved on a CF card even during inspection, which allows you to examine the data in your office at your convenience or transfer configuration settings to another Imagechecker.

You can also transfer image data via Ethernet. You can set the file name to be transferred, image output method, etc. The software which allows you to receive data is available on our website free of charge.

MICRO-IMAGECHECKER® PV310



Enhanced Functionality, Improved Performance

Improved

Smart Matching From 0° to 360°

The matching function has been improved to inspect workpieces rotated from 0° to 360°.

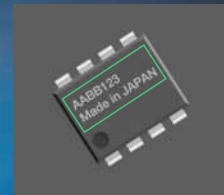

New Function

Auto Area Adjustment

The inspection area can be automatically adjusted to the workpiece size to cover slight variations (dimensional tolerance of workpieces).

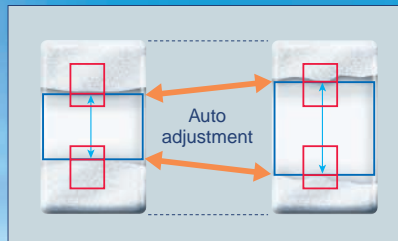

New Function

Low Contrast Matching

The workpiece can be detected even if the contrast to the background is low or if the workpiece itself is damaged.

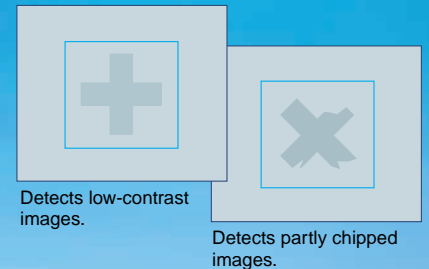

New Function

Flaw Detection

Scratches, stains, chipped edges, burrs and other defects that could previously only be detected by a more upscale model can now be detected.

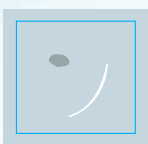

Surface scratches and stains

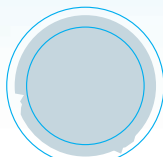

Chipping and burrs



Chipping and burrs

New Function

Filters Increase Reliability

13 filters are available to increase the reliability and accuracy of inspections. You may combine up to 5 filters.

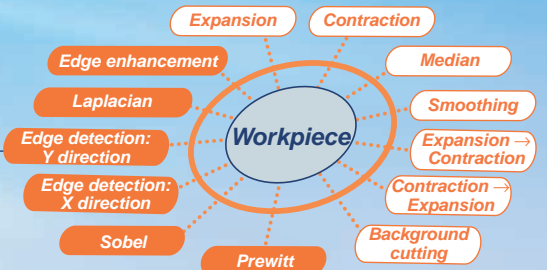

● Filter useful for noise removal

Expansion → Contraction

(Black noise removal)



● Filter useful for contour extraction

Sobel

(Edge detection)



High-Speed Enhancements

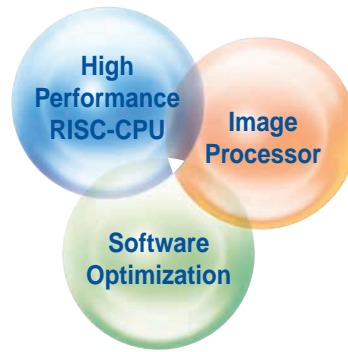

[High Speed 1]

Smart Matching

Detects the presence (or absence) of a pattern (object) in the search area that matches the template registered. Detection of sub-pixel position possible with gray scale matching. In addition, using the gray scale differential processing function, shape inspection, e.g. to detect chips or other flaws in an object, can also be carried out simultaneously.

[Processing Time]

Previous Model: 36.0 ms
PV310: 3.8 ms
 Condition: Without orientation correction
 Template: 128 x 128
 Search area: 512 x 480

Approx.
10
 times faster than previous model

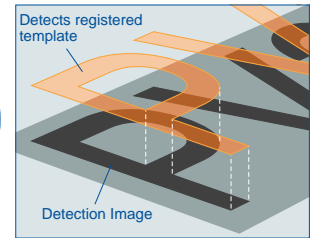

[High Speed 2]

Feature Extraction

Features, such as the number of objects, the area, central coordinates, angle of the main axis, projection width or perimeter length, can be extracted using a binary image.

[Processing Time]

Previous Model: 61.0 ms
PV310: 3.9 ms
 Condition: With orientation correction
 Template: 486 x 452
 Object color: Black

Approx.
16
 times faster than previous model



[High Speed 3]

Gray Scale Window

An area can be created in a 256 gray scale image, with a rectangular, circular or polygonal shape over the area where object detection is to take place. An average value for the brightness data (gray scale value) for all pixels in that area can be calculated.

[Processing Time]

Previous Model: 69.0 ms
PV310: 1.7 ms
 Condition: With orientation correction
 Inspection area: 486 x 452

Approx.
40
 times faster than previous model

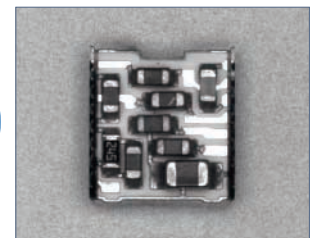

[High Speed 4]

Gray Scale Edge

The distance between lead pins or pitch size can be measured for an inspection object. Parameters allow settings to be made in great detail. Using the extreme accuracy of sub-pixel processing, the edge in question can be reliably extracted for a wide variety of object states.

[Processing Time]

Previous Model: 28.0 ms
PV310: 2.7 ms
 Condition: With orientation correction
 Inspection area: 200 x 160

Approx.
10
 times faster than previous model



Binary Window

[Processing Time] **PV310: 2.1 ms** Previous Model: 49.1 ms
 Conditions: With orientation correction, inspection area: 486 x 452

Judges whether a certain amount of area for an object is present using a binary image. High-speed processing is 23 times as fast as previous models, even when multiple inspection areas are specified.

Binary Edge

[Processing Time] **PV310: 0.9 ms** Previous Model: 1.8 ms
 Conditions: With orientation correction, inspection area: 200 x 160

Determination of position and simple size measurement can be carried out at approximately twice the speed of previous models. There is no effect on inspection speed even if the inspection area is increased for purposes of stability.

User-Friendly Interface

An operation keypad makes configuration as easy as child's play.
The color display is easy to read and allows you to grasp information quickly.

Rich Information Display

The high performance VGA monitor displays inspected objects on the screen with high fidelity. Operations and settings can be carried out easily via the pull-down menus and keypad. Readability has been improved by displaying guidelines and character information in color and using a large character font. In addition, parallel inspection output results can be monitored in color.

- **Currently Selected Model Number, Model Title and Shutter Speed**
- **Currently Displayed Image Type**
- **Message Area**
Displays various messages, sub-windows for checker settings and checker test results.
- **Overall Judgment Result**
Displays OK (in green) when the output judgment meets the judgment requirements set in "Overall Judgment"
- **Signal Output Status**
When the following signals are output, the box below each signal is illuminated. (RUN mode only)
R: READY signal
E: ERROR signal
1~8: D1 to D8 signals
- **Execution Time**

- **Menu Bar**
Displays menus for setting inspection conditions and the inspection environment.
- **Screen Display Area**
<RUN mode>
Displays images, checker areas, inspection results, etc. depending on the settings in Settings Mode.

<Settings Mode>
Displays images, checker areas, etc. Settings windows called from the menu bar are also displayed in this area.

Menu Background Settings

A semi-transparent mode, allowing operations to be carried out while viewing captured images, and a fill mode, which blocks out background colors, are both supported. You can select the menu background color and set it as default.

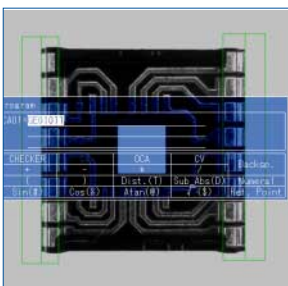

Semi-Translucent Mode

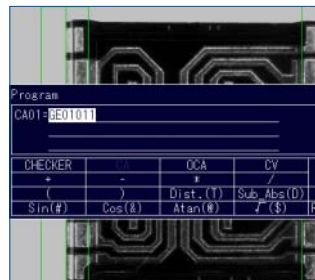

Fill Mode



Operation keypad

Just position the cursor on a menu item and press <Enter>.

Data Monitor

Up to 50 inspection results can be displayed in a list on the monitor, allowing the operator to check the results on the monitor. Threshold adjustment (upper and lower limit values) can also be changed on the data monitor without having to enter them in the settings menu. The size and display position can also be changed.

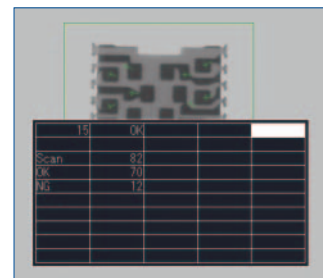

The PV310 can be used for a wide range of applications where high-speed processing is required, e.g. inspecting:

- Presence/absence of parts
- Part size
- Part orientation
- Presence/absence of date or serial no.
- Product nameplate label
- Remote control switch printing
- Cap tightness

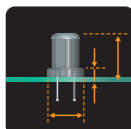

- Logo mark printing
- Flat cable width
- Label position
- Debris/dirt on part
- 7-segment illumination
- Substrate positioning
- Metal part picking, etc.

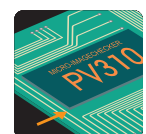

Full Selection of Interfaces

External interfaces are essential for image processing devices of the future. The PV310 is equipped with a full selection of interfaces that rival even large-scale devices.

Ethernet Connection

- The PV310 can be connected to a LAN using high-speed Ethernet (100BASE-TX) to meet various application requirements.
- Captured images and measurement data can be transmitted to a PC at high speed even during operation.
- The inspection status of multiple PV310 units can be monitored from a single PC.
- With the high-speed connection to a PC, backing up image data is also easy.



External Memory (CF Card) Support

- **In RUN mode:**
 - Can save captured images. [Storage capacity: Approx. 2,000 images (512 MB)]
 - Saves inspection results.
 - **In the setting mode:**
 - Backs up setting data and image data captured by the unit.
- Note: Backup image data can be used as regular bitmap files on a PC.



DIN Rail Installation

Connection of up to Two Identical Cameras

Up to two identical cameras can be connected. The following camera types are available.

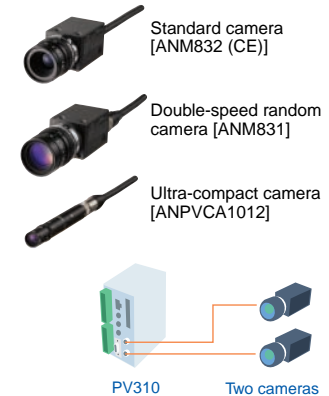

Operation Keypad

The dedicated keypad with an ergonomic structure provides excellent operability.



PLC Link Function

- The PV310 can communicate easily with external devices, such as PLCs, using the RS232C port.
- The PV310 can be connected to other companies' PLCs without requiring additional programming. Of course it can be connected to our PLCs, too.

Supported Models:

- Matsushita Electric Works PLCs
- OMRON Corporation - C, CV and CS1 series
- Mitsubishi Electric Corporation - A, Q and FX series
- Rockwell Automation DF1 protocol
- Fuji Electric SX series

VGA Monitor

Judgment results and program settings are displayed in color for outstanding visibility. (Captured images are in black and white.)



Note: Commercially available VGA monitors may also be connected (devices supporting horizontal synchronous frequency: 31.466KHz and vertical synchronous frequency: 59.94KHz only.)

Operation cannot be guaranteed with devices from other manufacturers.

Connection of up to Four Cameras by a Camera Switching Unit

Up to four identical standard or double-speed random cameras can be connected using a camera switching unit (option: ANPV3700).

* Excluding Ultra-compact camera

This connection is ideal for:

- Control of different inspections by a single controller unit
- Inspection of wide areas, and positioning of workpieces during the LCD lamination process, etc.

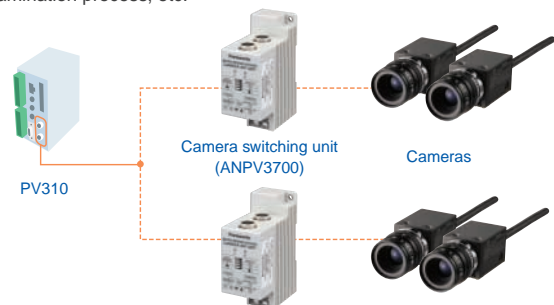

• Camera Switching Mode

Images taken by either of two cameras connected to the camera switching unit are output to the PV310.

* Available for ANM832 (CE) and ANM831

• Camera Image Split Mode (top/bottom split and left/right split)

Half images taken by two cameras are combined into one, which is then output to the PV310.

* Available for ANM832 (CE) only

Functions

Inspection programs for as many as 64 product types can be set.

Smart Matching

Improved

Detection of sub-pixel position possible with gray scale matching. In addition, using the gray scale differential processing function, shape inspection, etc. can also be carried out simultaneously. Memory capacity has been increased 4 times over previous models, allowing support for an even wider range of applications.

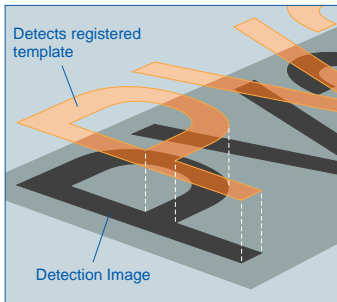

Differential Function

Based on the position information obtained by the matching function, the registered object and detected object are overlapped and compared on a pixel-by-pixel basis. Any pixels with a difference in brightness over a certain level are detected. The area value of such pixels can then be used to make pass/fail judgments.

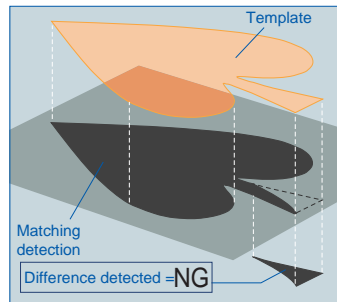

Numerical Calculation/Judgment Output

The numerical output function has been greatly simplified so that even a novice can set it easily. Operation has also become even easier as both numerical calculations and judgment output can now be set on the same screen (up to 96 formulas).



Feature Extraction

Features, such as the number of objects, workpieces, area, central coordinates, angle of the main axis, projection width or perimeter length can be extracted.

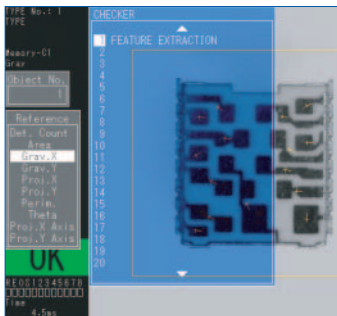

Gray Scale Window

An inspection area can be created in a 256 gray scale image, with a rectangular, circular or polygonal shape, over the area where object detection is to take place. An average value for the brightness data (gray scale value) for all pixels in that area can be calculated.

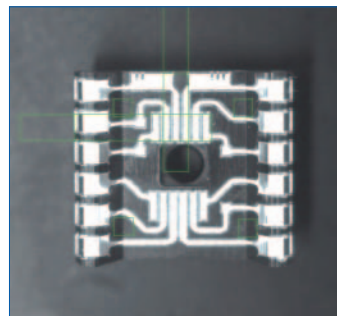

360° Contour Matching

Stable position detection is possible even for objects that overlap because their contours can be extricated. The range of settings has been doubled and support has been added for 4 cameras.



Rotation/Position Adjustment

Highly accurate and reliable inspection is realized by automatically adjusting object orientation and stop position deviation. Complicated adjustments are also possible using the multiple adjustment function.

Multiple Adjustment

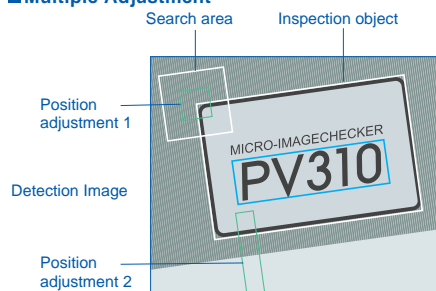

- Position Adjustment
- Rotation Adjustment
- Multiple Adjustment
- Priority Adjustment

Mask

The shape of the inspection area can be set to match particular targets. Mask area settings can also be combined to allow efficient inspections to be carried out only on the necessary parts.

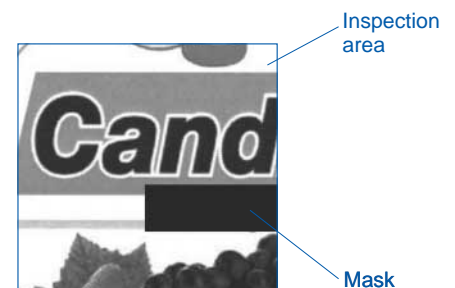

Settings

A full range of inspection modes to meet customers' needs. Support functions for optimal settings.

Setting Help

This function helps the user make settings that in the past relied heavily on human judgment, e.g. setting the focus, adjusting the aperture, finding the optimal settings for the parallel monitor, lighting adjustment, density profile display, etc.

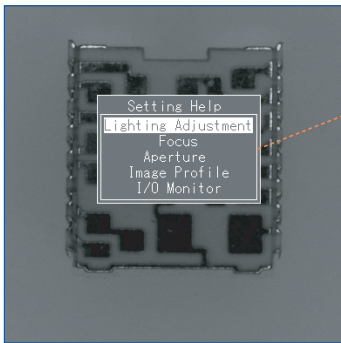

Density Profile

Gray scale values for the image are displayed in an easily understandable table.

Parallel Monitor

I/O Monitor							
RDY	ERR	REN	STR	DVF			
D1	D2	D3	D4	D5	D6	D7	D8
STA	ACK	TRF	FCT1	FCT2			
IN1	IN2	IN3	IN4	IN5	IN6	IN7	IN8

The "Parallel Monitor" function is also useful during actual operation for monitoring parallel input and output signals to and from the PV310.

Collective Movement

Checkers that have been set can be moved collectively all at once. This is useful for fine adjustment when re-setting cameras. It is also convenient when transferring product type data to a different device.

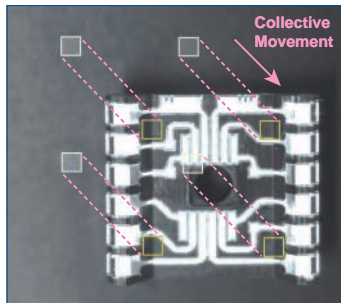

Security

Passwords can be set in "environment" - "initial settings". Vital setting data can be protected from careless operating errors.

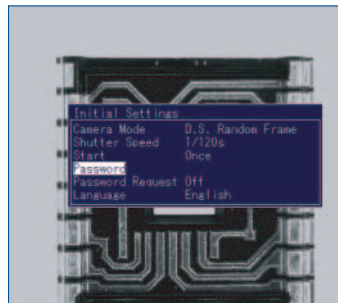

Inspection Mode

The PV300 is equipped with a variety of inspection modes, such as position adjustment, rotation adjustment, gray scale and binarization, to support a wide range of inspection needs.

- Position Adjustment
 - Binary Edge
 - Gray Scale Edge
 - Feature Extraction
 - Matching
- Rotation Adjustment
 - Binary Horizontal Edge
 - Binary Vertical Edge
 - Gray Scale Horizontal Edge
 - Gray Scale Vertical Edge
 - Feature Extraction
 - Matching (Two checkers)
 - Contour Matching
 - 360° Matching
- Binary Window
- Gray Scale Window
- Gray Scale Edge
- Binary Edge
- Feature Extraction
- Smart Matching
- Contour Matching
- Flaw Detection

Image Storage

Using a calendar function, the date a defect was discovered and the number of inspections can be added to saved color images. This is useful for later verification (checking a defective product against a saved image) and for analyzing defect tendencies.

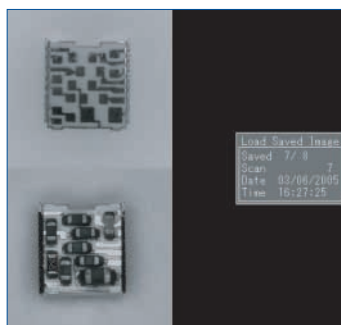

Global Support (Multi-language Display & CE Compliance)

Considering that the device may be shipped overseas, the display can be switched between 6 different languages. The controller and dedicated cameras are standardized items and CE compliant.

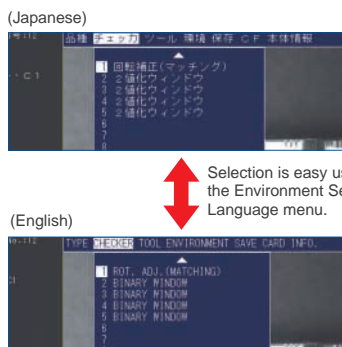

Support

Our popular menus and support software greatly improve workability during inspections.

Download from CF Card

A program stored on a Compact Flash card can be downloaded to the controller unit using a parallel external signal.

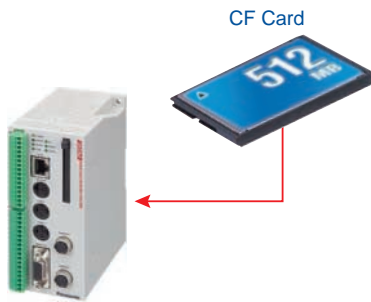

Statistical Support

Statistical data such as the maximum, minimum and average data values, number of failed results, etc. can be displayed. Maximum, minimum and average values in pass judgments can be checked, allowing them to be used as a guide for subsequent upper and lower limit settings.

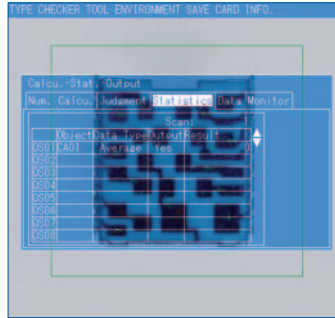

Print Screen

Display and settings screens can be saved to a memory card as bitmap files. This is convenient for creating documents or for checking previous images.

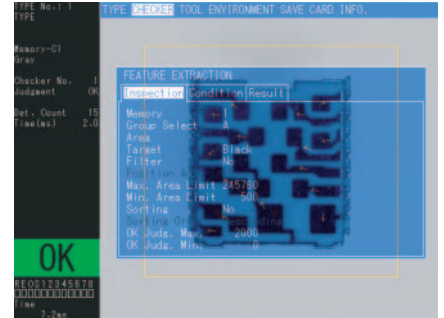

Parallel Handshake Support

Parallel external output of 96 inspection and numerical calculation results is available.

Full Peripheral Support with "AXTOOL" Vision Support Tool

The "AXTOOL" Vision Support Tool is full of enhanced functions and connects to PV310s using a high-speed interface (100BASE-TX) to meet various application requirements.

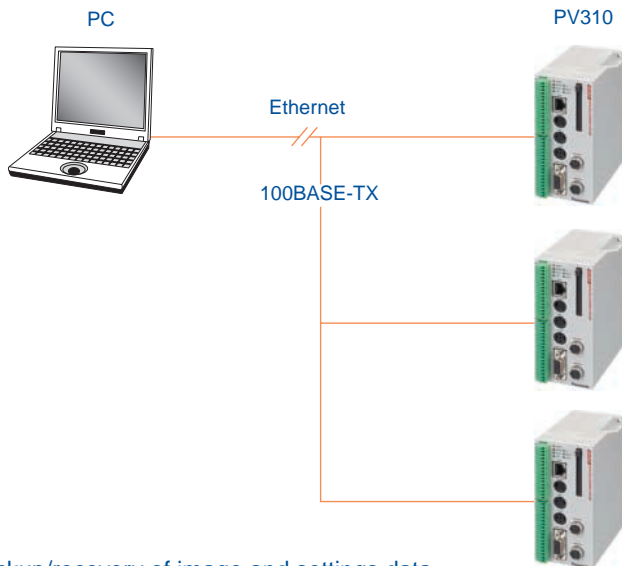

● Product type data backup screen

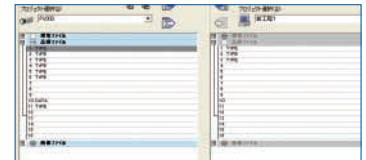

● Document display screen



● Image data display screen

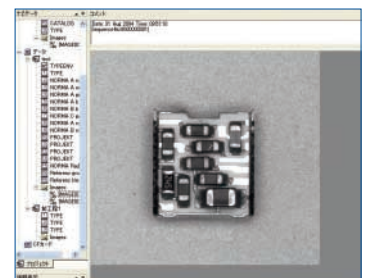

1. Backup/recovery of image and settings data
2. Copy/move/deletion of image and settings data
3. Check saved images on PC
4. Convert settings data to CSV format. Editing possible with Excel.

Download AXTOOL for free from:
<http://www.mew.co.jp/ac/e/fasys/vision/>

Note: The screen design may differ from that shown.

Dimensions (Unit: mm)

● Main Unit (Controller) ANPV0310EDN

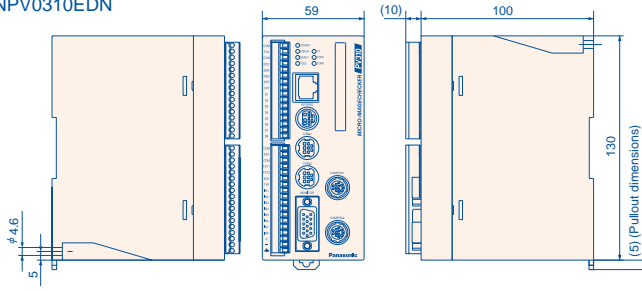

● Operation Keypad ANM852** ANM852**CE

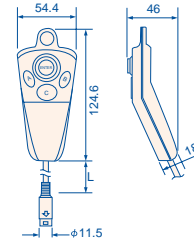

● Double-Speed Random Camera: C Mount ANM831

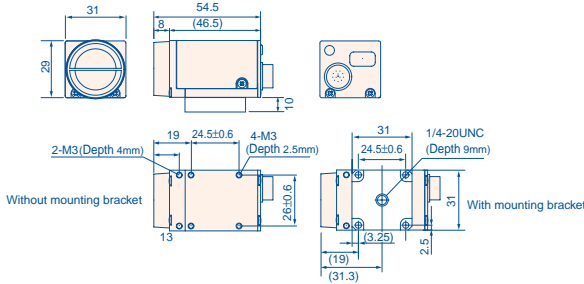

● Standard Camera: CS Mount ANM832/ANM832CE/ANM83203

Note *1) ANM832: 3000
ANM832CE: 2780
ANM83203: 300

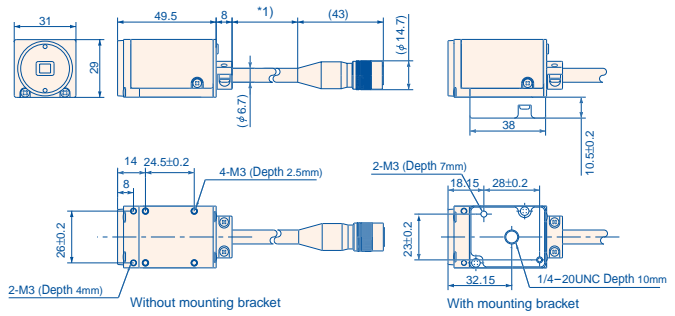

● Ultra-Compact Camera ANPVC1012

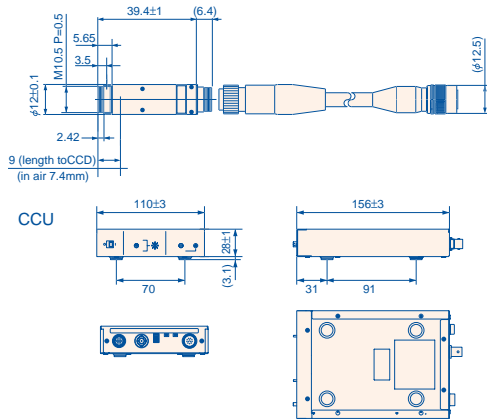

● Double-Speed Random Camera Cable ANM84303 ANM84303CE

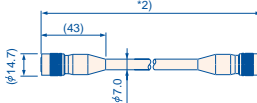

Note *2) This is the length of cable in use.
Becomes slightly shorter with CE attached.

● Double-Speed Random Camera Cable (Durable Type) ANM84603

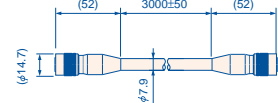

● Camera Extension Cable ANM840**A ANM840**ACE

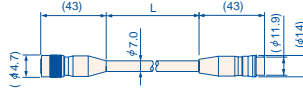

● Camera Extension Cable (Durable Type) ANM845**

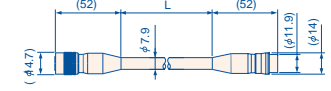

The boxes correspond to the length of cable in use.

● Lens

Mounting screws (lenses with lock only)

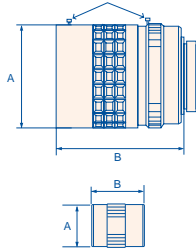

C Mount Lens			A	B
ANB843L	f=8.5	φ42	42	40
ANB845NL	f=16	φ30	33	33
ANB846NL	f=25	φ30	37.3	37.3
ANB847L	f=50	φ48	48	48
ANM88161	f=16	φ30.5	25	25
ANM88251	f=25	φ30.5	25.5	25.5
ANM8850	f=50	φ27.5	38.5	38.5
ANM88501	f=50	φ30.5	38.5	38.5

Ultra-Compact Lens			A	B
ANPVL0401	f=4	φ12	14.8	14.8
ANPVL1201	f=12	φ12	14.4	14.4
ANPVL3001	f=30	φ12	25.3	25.3

● Camera Switching Unit ANPV3700

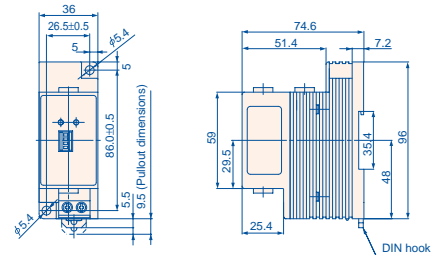

● VGA Monitor ANMX8301

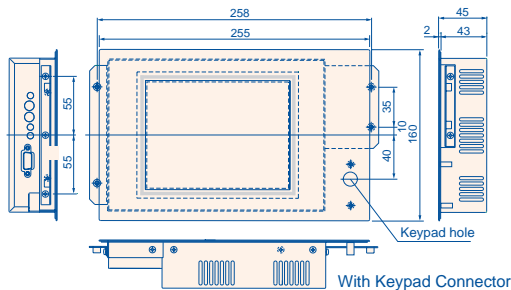

ANMX8301

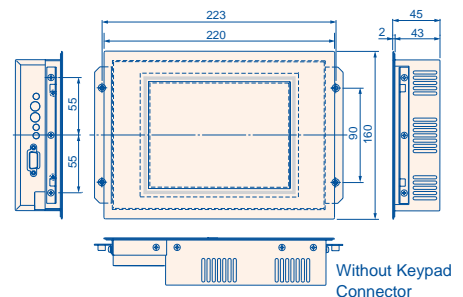

● Keypad Cable (between VGA monitor and controller) ANMX8333*

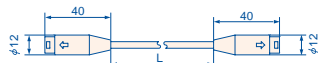

● VGA Monitor Cable ANMX8331*



Part Nos. and Specifications

Part Nos.

Product Name	Specification	CE	Part No.
PV310 Controller	JPN/ENG	NPN	ANPV0310JDN
	JPN/ENG	PNP	ANPV0310JDP
	ENG/JPN	NPN	ANPV0310EDN
	ENG/GER/FRN/ITA/SPN	PNP	ANPV0310MDP
Double-Speed Random Camera (C Mount)	progressive support	○	ANM831
Standard Camera (CS Mount)	with 3 m cable		ANM832
	with 3 m cable	○	ANM832CE
	with 30 cm cable		ANM83203
Double-Speed Random Camera Cable	3 m		ANM84303
	3 m	○	ANM84303CE
	Double-Speed Random Camera Cable (Durable Type) = 3 m		ANM84603
Ultra-Compact Camera	12-mm diameter		ANPVCA1012
Camera Extension Cable	2 m extension: Total 5 m		ANM84002A
	7 m extension: Total 10 m		ANM84007A
	12 m extension: Total 15 m		ANM84012A
	17 m extension: Total 20 m		ANM84017A
	2 m extension: Total 5 m	○	ANM84002ACE
	7 m extension: Total 10 m	○	ANM84007ACE
	12 m extension: Total 15 m	○	ANM84012ACE
	17 m extension: Total 20 m	○	ANM84017ACE
	Durable extension 2 m: Total 5 m		ANM84502
	Durable extension 7 m: Total 10 m		ANM84507
	Durable extension 12 m: Total 15 m		ANM84512
Durable extension 17 m: Total 20 m		ANM84517	
Camera Switching Unit	Supports standard camera and double-speed random camera	○	ANPV3700
VGA Monitor	With keypad connector		ANMX8300
	Without keypad connector		ANMX8301
Kit for Installation on Main Unit	With keypad connector. Mounting brackets (ANMX835)/Monitor cable: 0.5 m/Keypad cable: 0.5 m		ANMX8302
	Without keypad connector. Mounting brackets (ANMX835)/Monitor cable: 0.5 m		ANMX8303
Controller Mounting Brackets	Brackets for mounting VGA monitor on the controller		ANMX835
Monitor Cable	Cable length: 0.5 m (for single-unit mounting)		ANMX83310
	Cable length: 1 m		ANMX83311
	Cable length: 2 m		ANMX83312
	Cable length: 3 m		ANMX83313
	Cable length: 0.5 m		ANMX83330
(With keypad controller) Keypad Cable for Connection to Main Unit	Cable length: 1 m		ANMX83331
	Cable length: 2 m		ANMX83332
	Cable length: 3 m		ANMX83333
C Mount Lens	f8.5	C mount lens with lock	ANB843L
	f16	C mount lens with lock	ANB845NL
	f25	C mount compact lens with lock	ANM88161
	f25	C mount compact lens	ANB846NL
	f25	C mount compact lens with lock	ANM88251
	f50	C mount super-compact lens with lock	ANB847L
	f50	C mount super-compact lens with lock	ANM88501
Ultra-Compact Camera Lens	f4	Ultra-Compact Lens ϕ 12mm	ANPVL0401
	f12	Ultra-Compact Lens ϕ 12mm	ANPVL1201
	f30	Ultra-Compact Lens ϕ 12mm	ANPVL3001
Adapter Ring	5 mm		ANB84805
Operation Keypad	0.5/1/5/10/20/40 mm		ANB848
	with 2 m cable		ANM85202
	with 3 m cable		ANM85203
	with 5 m cable		ANM85205
	with 10 m cable		ANM85210
	with 2 m cable	○	ANM85202CE
	with 3 m cable	○	ANM85203CE
	with 5 m cable	○	ANM85205CE
COM Port Cable	for connection to PC (D-SUB: 9 pins): 3 m		ANM81103
	for connection to PLC (discrete-wire cable): 3 m		ANM81303

General Specifications

■ Controller: ANPV0310 ***

Item	Specification
Rated Operating Voltage	24 V DC
Operating Voltage Range	21.6 to 26.4 V DC (including ripples)
Rated Current Consumption	0.7 A max. (1 camera) 0.9 A max. (2 cameras)
Ambient Temperature (in use)	0 to 50°C (no freezing or condensation)
Storage Ambient Temperature	-20 to +60°C (no freezing or condensation)
Ambient Humidity (in use and storage)	35 to 75% (at 25°C with no freezing or condensation)
Noise Immunity	1000 V pulse width 50 ns/1 μ s (using noise simulator method)
Vibration Resistance	10 to 55 Hz, 1 cycle/1 min. Double amplitude of 0.75 mm. 30 min. each in X, Y and Z directions
Shock Resistance	196 m/s ² , 5 times each in X, Y and Z directions
Weight	Approx. 450 g
Dimensions (mm)	W59 × H130 × D100 (with connector 110)

■ Camera Switching Unit: ANPV3700

Item	Specification	
Functions	Camera Switching	2-camera input - 1-camera output (Switching by external signal input/Manual switching)
	Camera Image Split ANM832 (CE) only	2-camera input - 1-camera output of top/bottom split images/ 2-camera input - 1-camera output of left/right split images
External Switching Signal Input	1 input, photo-coupler bidirectional input supported, 5 to 24 V DC	
DIP Switch Setting	LOCAL/REMOTE, NORMAL/DIV, A/B, Top-Bottom/Left-Right	
Rated Voltage Range	12 V DC (supplied from the MICRO-IMAGECHECKER unit)	
Weight	Approx. 150 g (Main unit only)	
Included items: 1 connection cable (30 cm), 2 ferrite cores, and 1 installation manual		
The operation condition requirements are the same as those for the PV310 Controller.		

Functional Specifications

● Functional Specifications

Item	Specification	
Settings Data Storage Capacity	Approx. 4 MB	
Frame Memory	512 x 480 (pixels)	
Operation Environment	Menu selection by dedicated keypad Key Emulation Menu selection by serial command	
Input/Output	Cameras	2 Standard cameras, double-speed random cameras, or ultra-compact cameras (max. 4 cameras when using camera switching unit, excluding ultra-compact camera)
	Monitor Output	Color VGA output
	Memory Card	Compact Flash: 1 slot
	Serial	RS-232C x 1 channel
	Parallel	Input: 13 points; output: 14 points; removable screw-down terminal block
	Keypad Input	1 Connector for dedicated keypad (ANM8520*)
	Tools	Ethernet: 1 channel

● Image Processing Functional Specifications

Item	Specification
Monitor Display	Full color VGA/gray scale image/ binary image Two-screen compressed display: side-by-side display (when gray scale image selected) through/memory, data monitor, marker, + information display region (128x480)
Number of Connected Cameras	Max. 2 cameras (Max. 4 cameras using camera switching unit, excluding ultra compact camera)
Processing Method	Gray scale processing - Binary processing
No. of Product Types	Max. 64 types (depends on settings data capacity)
Inspection Functions	Max. 99 checkers/product type • Position adjustment, rotation adjustment, binary window • Gray scale window, binary edge, gray scale edge • Feature extraction, smart matching, contour matching, scratch detection
Numerical Computation	Max. 96 functions/product type Operators: 4-operation calculation, $\sqrt{\quad}$, arc tangent, distance between 2 points, parenthesis, sin, cos, absolute value of difference
Judgment Output	Max. 96 functions/product type Operators: NOT/AND/OR/XOR/parenthesis
Statistics	Max. 96/product type Calculation of no. of passes/no. of fails/pass average/pass distribution/pass max. value/pass min. value/pass range (for judgment output no. of passes/no. of fails only)
Data Monitor	Max. 50/product type Displayed on screen in table form during RUN Title input and substitution of numerical computation results, judgment output results, statistical results and product numbers possible

Item	Specification	
Operation Data	Max. 4/environment Substitution in numerical computation possible	
Marker	Max. 8/product type Graphic display on screen during RUN	
External Input/Output	Serial	RS-232C-1ch (max. speed 115200 bps) • Input: start/product type switch/camera display switch/template re-registration/CompactFlash settings restore/reference to and alteration of upper and lower values for numerical computation/reference to and alteration of binary level/reference to and alteration of gray scale edge thresholds/data storage/length input for input commands for statistics initialization (for PLC) • Output: output (no. of inspections/judgment output/numerical computations/statistics) synchronous or asynchronous to inspection start trigger • Computer link support: Supported models: • Matsushita Electric Works PLC • OMRON Corporation - C, CV and CS1 series • Mitsubishi Electric Corporation - A, Q and FX series • Rockwell Automation DF1 protocol • Fuji Electric SX series
	Parallel	Input: 13 points; output: 14 points • Input: start/product type switch/camera display switch/template re-registration/data restore from Compact Flash • Output: ready/error/flush/image acquired/strobe/judgment output data/synchronous output (no. of inspections/judgment output/numerical computation/statistics) possible by handshake output
	Ethernet (1 channel)	• Output: no. of inspections/judgment output/numerical computations/statistics/settings data/image backup and restore/conversion to documentation for settings data (Vision AXTOOL)
	CF Card (1 slot)	• Output: no. of inspections/judgment output/numerical computations/statistics/settings data/image backup and restore/screen dumps
	Other	Display Functions Transparent menu/parallel output status monitor/reference coordinate display/checkers with fail results highlighted in different color
Collective Movement	Collective movement of set checkers in units of position/rotation adjustment groups	
Image Storage	Max. 16 images/camera Each time/storage possible according to judgment result Test runs available on stored images Display of date and time saved Function to maintain display of last image saved	
Setting Help	Focusing/aperture adjustment/parallel monitor/lighting adjustment/gray scale profile display	
Calendar	Calendar information added to stored images File time stamp	
Password	Password function for when moving between settings modes	

Please contact

Panasonic Electric Works Co., Ltd.

Automation Controls Business Unit

■ Head Office: 1048, Kadoma, Kadoma-shi, Osaka 571-8686, Japan

■ Telephone: +81-6-6908-1050 ■ Facsimile: +81-6-6908-5781

panasonic-electric-works.net/ac

Panasonic®

All Rights Reserved © 2010 COPYRIGHT Panasonic Electric Works

单击下面可查看定价，库存，交付和生命周期等信息

[>>Panasonic\(松下\)](#)