

Panasonic

ideas for life

High breakdown voltage type
is available (1.5 kV between
open contacts)

TX-D RELAYS

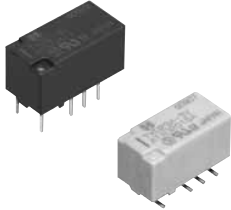

RoHS compliant

FEATURES

- ! 1. Lineup now includes high breakdown voltage type that achieves breakdown voltage between open contacts of 1,500 V AC.

Surge breakdown voltage between open contacts:
1,500 V $10 \times 160 \mu\text{sec}$. (FCC part 68)
Surge breakdown voltage between contact and coil:
6,000 V $1.2 \times 50 \mu\text{sec}$. (EN60950)

2. **Approved to the supplementary insulation class in the EN standards (EN60950).**

The insulation distance between the contact and coil meet the supplementary insulation class of the EN60950 standards as required for equipment connected to the telephone lines in Europe.

Satisfies the following conditions:

- Clearances: 2.0 mm .079 inch or more
- Creepage distance: 2.5 mm .098 inch or more

- ! 3. **3,000 V breakdown voltage between contact and coil. (Surge breakdown voltage 6,000 V type)**

The body block construction of the coil that is sealed formation offers a high breakdown voltage of 3,000 V between contact and coil.

4. **Nominal operating power: High sensitivity of 200mW**

By using the highly efficient polar magnetic circuit "seesaw balance mechanism", a nominal operating power of 200 mW has been achieved.

5. **High contact capacity: 2 A 30 V DC**

6. **High contact reliability achieved with gold-clad crossbar twin contacts and the use of gas expelling materials during formation.**

*We also offer a range of products with AgPd contacts suitable for use in low level load analog circuits (Max. 10V DC 10 mA).

7. **Outstanding vibration and shock resistance.**

Functional shock resistance: 750 m/s²

Destructive shock resistance:
1,000 m/s²

Functional vibration resistance:

10 to 55 Hz (at double amplitude of 3.3 mm .130 inch)

Destructive vibration resistance:

10 to 55 Hz (at double amplitude of 5 mm .197 inch)

8. **Sealed construction allows automatic washing.**

9. **A range of surface-mount types is also available.**

SA: Low-profile surface-mount terminal type

SS: Space saving surface-mount terminal type

10. **M.B.B. type available (Surge breakdown voltage 2,500 V type only)**

TYPICAL APPLICATIONS

1. Facsimile
2. Modem
3. Communications (xDSL)
4. Medical equipment
5. Automotive equipment
6. Security

ORDERING INFORMATION

TXD - - - - - - -

Contact arrangement

2: 2 Form C

Surface-mount availability

Nil: Standard PC board terminal

SA: SA type SS: SS type

Operating function

Nil: Single side stable L: 1 coil latching

Type of operation

Nil: Standard type

2M: M.B.B. type (Surge breakdown voltage 2,500 V and Single side stable type only)

Terminal shape

Nil: Standard PC board terminal or surface-mount terminal

Nominal coil voltage (DC)

1,5, 3, 4.5, 5, 6, 9, 12, 24V

Contact material/Surge breakdown voltage (between contact and coil)/Breakdown (between open contacts)

Nil: Standard contact (Ag+Au clad), 2,500 V/1,000 V

1: AgPd contact (low level load); AgPd+Au clad (stationary), AgPd (movable), 2,500 V/1,000 V

3: Standard contact (Ag+Au clad), 6,000 V/1,500 V

! 4: AgPd contact (low level load); AgPd+Au clad (stationary), AgPd (movable), 6,000 V/1,500 V

6: Standard contact (Ag+Au clad), 6,000 V/1,000 V

7: AgPd contact (low level load); AgPd+Au clad (stationary), AgPd (movable), 6,000 V/1,000 V

Packing style

Nil: Tube packing

X: Tape and reel (picked from 1/3/4/5-pin side)

Z: Tape and reel packing (Picked from the 8/9/10/12-pin side)

Note: In case of 5 V transistor drive circuit, it is recommended to use 4.5 V type relay.

TYPES

1. Standard (B.B.M.) type/Surge breakdown voltage (between contact and coil) 2,500 V/ Breakdown voltage (between open contacts) 1,000 V

1) Standard PC board terminal

| Contact arrangement | Nominal coil voltage | Single side stable | 1 coil latching |
|---------------------|----------------------|--------------------|-----------------|
| | | Part No. | Part No. |
| 2 Form C | 1.5V DC | TXD2-1.5V | TXD2-L-1.5V |
| | 3V DC | TXD2-3V | TXD2-L-3V |
| | 4.5V DC | TXD2-4.5V | TXD2-L-4.5V |
| | 5V DC | TXD2-5V | TXD2-L-5V |
| | 6V DC | TXD2-6V | TXD2-L-6V |
| | 9V DC | TXD2-9V | TXD2-L-9V |
| | 12V DC | TXD2-12V | TXD2-L-12V |
| | 24V DC | TXD2-24V | TXD2-L-24V |

Standard packing: Tube: 40 pcs.; Case: 1,000 pcs.

Note: Please add "-1" to the end of the part number for AgPd contacts (low level load).

2) Surface-mount terminal

(1) Tube packing

| Contact arrangement | Nominal coil voltage | Single side stable | 1 coil latching |
|---------------------|----------------------|--------------------|-----------------|
| | | Part No. | Part No. |
| 2 Form C | 1.5V DC | TXD2S□-1.5V | TXD2S□-L-1.5V |
| | 3V DC | TXD2S□-3V | TXD2S□-L-3V |
| | 4.5V DC | TXD2S□-4.5V | TXD2S□-L-4.5V |
| | 5V DC | TXD2S□-5V | TXD2S□-L-5V |
| | 6V DC | TXD2S□-6V | TXD2S□-L-6V |
| | 9V DC | TXD2S□-9V | TXD2S□-L-9V |
| | 12V DC | TXD2S□-12V | TXD2S□-L-12V |
| | 24V DC | TXD2S□-24V | TXD2S□-L-24V |

□: For each surface-mount terminal identification, input the following letter. SA type: A, SS type: S

Standard packing: Tube: 40 pcs.; Case: 1,000 pcs.

Note: Please add "-1" to the end of the part number for AgPd contacts (low level load).

(2) Tape and reel packing

| Contact arrangement | Nominal coil voltage | Single side stable | 1 coil latching |
|---------------------|----------------------|--------------------|-----------------|
| | | Part No. | Part No. |
| 2 Form C | 1.5V DC | TXD2S□-1.5V-Z | TXD2S□-L-1.5V-Z |
| | 3V DC | TXD2S□-3V-Z | TXD2S□-L-3V-Z |
| | 4.5V DC | TXD2S□-4.5V-Z | TXD2S□-L-4.5V-Z |
| | 5V DC | TXD2S□-5V-Z | TXD2S□-L-5V-Z |
| | 6V DC | TXD2S□-6V-Z | TXD2S□-L-6V-Z |
| | 9V DC | TXD2S□-9V-Z | TXD2S□-L-9V-Z |
| | 12V DC | TXD2S□-12V-Z | TXD2S□-L-12V-Z |
| | 24V DC | TXD2S□-24V-Z | TXD2S□-L-24V-Z |

□: For each surface-mount terminal identification, input the following letter. SA type: A, SS type: S

Standard packing: Tape and reel: 500 pcs.; Case: 1,000 pcs.

Notes: 1. Tape and reel packing symbol "-Z" is not marked on the relay. "X" type tape and reel packing (picked from 1/3/4/5-pin side) is also available.

2. Please add "-1" to the part number for AgPd contacts (low level load). (Ex. TXD2SA-1.5V-1-Z)

2. M.B.B type/Surge breakdown voltage (between contact and coil) 2,500 V/ Breakdown voltage (between open contacts) 1,000 V

1) Standard PC board terminal

| Contact arrangement | Nominal coil voltage | Single side stable |
|---------------------|----------------------|--------------------|
| | | Part No. |
| 2 Form C | 1.5V DC | TXD2-2M-1.5V |
| | 3V DC | TXD2-2M-3V |
| | 4.5V DC | TXD2-2M-4.5V |
| | 5V DC | TXD2-2M-5V |
| | 6V DC | TXD2-2M-6V |
| | 9V DC | TXD2-2M-9V |
| | 12V DC | TXD2-2M-12V |
| | 24V DC | TXD2-2M-24V |

Standard packing: Tube: 40 pcs.; Case: 1,000 pcs.

2) Surface-mount terminal

(1) Tube packing

| Contact arrangement | Nominal coil voltage | Single side stable |
|---------------------|----------------------|--------------------|
| | | Part No. |
| 2 Form C | 1.5V DC | TXD2S□-2M-1.5V |
| | 3V DC | TXD2S□-2M-3V |
| | 4.5V DC | TXD2S□-2M-4.5V |
| | 5V DC | TXD2S□-2M-5V |
| | 6V DC | TXD2S□-2M-6V |
| | 9V DC | TXD2S□-2M-9V |
| | 12V DC | TXD2S□-2M-12V |
| | 24V DC | TXD2S□-2M-24V |

□: For each surface-mount terminal identification, input the following letter. SA type: A, SS type: S

Standard packing: Tube: 40 pcs.; Case: 1,000 pcs.

(2) Tape and reel packing

| Contact arrangement | Nominal coil voltage | Single side stable |
|---------------------|----------------------|--------------------|
| | | Part No. |
| 2 Form C | 1.5V DC | TXD2S□-2M-1.5V-Z |
| | 3V DC | TXD2S□-2M-3V-Z |
| | 4.5V DC | TXD2S□-2M-4.5V-Z |
| | 5V DC | TXD2S□-2M-5V-Z |
| | 6V DC | TXD2S□-2M-6V-Z |
| | 9V DC | TXD2S□-2M-9V-Z |
| | 12V DC | TXD2S□-2M-12V-Z |
| | 24V DC | TXD2S□-2M-24V-Z |

□: For each surface-mount terminal identification, input the following letter. SA type: A, SS type: S

Standard packing: Tape and reel: 500 pcs.; Case: 1,000 pcs.

Notes: 1. Types designed to withstand strong vibration caused, for example, by the use of terminal cutters, can also be ordered.

However, please contact us if you need parts for use in low level load. (Ex. TXD2SA-2M-1.5V-1-Z)

2. Tape and reel packing symbol "-Z" is not marked on the relay. "X" type tape and reel packing (picked from 1/3/4/5-pin side) is also available.

! **3. Standard (B.B.M.) type/Surge breakdown voltage (between contact and coil) 6,000 V/ Breakdown voltage (between open contacts) 1,000 V**

1) Standard PC board terminal

| Contact arrangement | Nominal coil voltage | Single side stable | 1 coil latching |
|---------------------|----------------------|--------------------|-----------------|
| | | Part No. | Part No. |
| 2 Form C | 1.5V DC | TXD2-1.5V-6 | TXD2-L-1.5V-6 |
| | 3V DC | TXD2-3V-6 | TXD2-L-3V-6 |
| | 4.5V DC | TXD2-4.5V-6 | TXD2-L-4.5V-6 |
| | 5V DC | TXD2-5V-6 | TXD2-L-5V-6 |
| | 6V DC | TXD2-6V-6 | TXD2-L-6V-6 |
| | 9V DC | TXD2-9V-6 | TXD2-L-9V-6 |
| | 12V DC | TXD2-12V-6 | TXD2-L-12V-6 |
| | 24V DC | TXD2-24V-6 | TXD2-L-24V-6 |

Standard packing: Tube: 40 pcs.; Case: 1,000 pcs.

Note: Please add "-7" to the end of the part number for AgPd contacts (low level load).

2) Surface-mount terminal

(1) Tube packing

| Contact arrangement | Nominal coil voltage | Single side stable | 1 coil latching |
|---------------------|----------------------|--------------------|-----------------|
| | | Part No. | Part No. |
| 2 Form C | 1.5V DC | TXD2S□-1.5V-6 | TXD2S□-L-1.5V-6 |
| | 3V DC | TXD2S□-3V-6 | TXD2S□-L-3V-6 |
| | 4.5V DC | TXD2S□-4.5V-6 | TXD2S□-L-4.5V-6 |
| | 5V DC | TXD2S□-5V-6 | TXD2S□-L-5V-6 |
| | 6V DC | TXD2S□-6V-6 | TXD2S□-L-6V-6 |
| | 9V DC | TXD2S□-9V-6 | TXD2S□-L-9V-6 |
| | 12V DC | TXD2S□-12V-6 | TXD2S□-L-12V-6 |
| | 24V DC | TXD2S□-24V-6 | TXD2S□-L-24V-6 |

□: For each surface-mount terminal identification, input the following letter. SA type: A, SS type: S

Standard packing: Tube: 40 pcs.; Case: 1,000 pcs.

Note: Please add "-7" to the end of the part number for AgPd contacts (low level load).

(2) Tape and reel packing

| Contact arrangement | Nominal coil voltage | Single side stable | 1 coil latching |
|---------------------|----------------------|--------------------|-------------------|
| | | Part No. | Part No. |
| 2 Form C | 1.5V DC | TXD2S□-1.5V-6-Z | TXD2S□-L-1.5V-6-Z |
| | 3V DC | TXD2S□-3V-6-Z | TXD2S□-L-3V-6-Z |
| | 4.5V DC | TXD2S□-4.5V-6-Z | TXD2S□-L-4.5V-6-Z |
| | 5V DC | TXD2S□-5V-6-Z | TXD2S□-L-5V-6-Z |
| | 6V DC | TXD2S□-6V-6-Z | TXD2S□-L-6V-6-Z |
| | 9V DC | TXD2S□-9V-6-Z | TXD2S□-L-9V-6-Z |
| | 12V DC | TXD2S□-12V-6-Z | TXD2S□-L-12V-6-Z |
| | 24V DC | TXD2S□-24V-6-Z | TXD2S□-L-24V-6-Z |

□: For each surface-mount terminal identification, input the following letter. SA type: A, SS type: S

Standard packing: Tape and reel: 500 pcs.; Case: 1,000 pcs.

Notes: 1. Tape and reel packing symbol "-Z" is not marked on the relay. "X" type tape and reel packing (picked from 1/3/4/5-pin side) is also available.

2. Please add "-7" to the part number for AgPd contacts (low level load). (Ex. TXD2SA-1.5V-7-Z)

 **4. Standard (B.B.M.) type/Surge breakdown voltage (between contact and coil) 6,000 V/ Breakdown voltage (between open contacts) 1,500 V (High breakdown voltage type)**

1) Standard PC board terminal

| Contact arrangement | Nominal coil voltage | Single side stable | 1 coil latching |
|---------------------|----------------------|--------------------|-----------------|
| | | Part No. | Part No. |
| 2 Form C | 1.5V DC | TXD2-1.5V-3 | TXD2-L-1.5V-3 |
| | 3V DC | TXD2-3V-3 | TXD2-L-3V-3 |
| | 4.5V DC | TXD2-4.5V-3 | TXD2-L-4.5V-3 |
| | 5V DC | TXD2-5V-3 | TXD2-L-5V-3 |
| | 6V DC | TXD2-6V-3 | TXD2-L-6V-3 |
| | 9V DC | TXD2-9V-3 | TXD2-L-9V-3 |
| | 12V DC | TXD2-12V-3 | TXD2-L-12V-3 |
| | 24V DC | TXD2-24V-3 | TXD2-L-24V-3 |

Standard packing: Tube: 40 pcs.; Case: 800 pcs.

Note: Please add "-4" to the end of the part number for AgPd contacts (low level load).

2) Surface-mount terminal

(1) Tube packing

| Contact arrangement | Nominal coil voltage | Single side stable | 1 coil latching |
|---------------------|----------------------|--------------------|-----------------|
| | | Part No. | Part No. |
| 2 Form C | 1.5V DC | TXD2S□-1.5V-3 | TXD2S□-L-1.5V-3 |
| | 3V DC | TXD2S□-3V-3 | TXD2S□-L-3V-3 |
| | 4.5V DC | TXD2S□-4.5V-3 | TXD2S□-L-4.5V-3 |
| | 5V DC | TXD2S□-5V-3 | TXD2S□-L-5V-3 |
| | 6V DC | TXD2S□-6V-3 | TXD2S□-L-6V-3 |
| | 9V DC | TXD2S□-9V-3 | TXD2S□-L-9V-3 |
| | 12V DC | TXD2S□-12V-3 | TXD2S□-L-12V-3 |
| | 24V DC | TXD2S□-24V-3 | TXD2S□-L-24V-3 |

□: For each surface-mount terminal identification, input the following letter. SA type: A, SS type: S

Standard packing: Tube: 40 pcs.; Case: 800 pcs.

Note: Please add "-4" to the end of the part number for AgPd contacts (low level load).

(2) Tape and reel packing

| Contact arrangement | Nominal coil voltage | Single side stable | 1 coil latching |
|---------------------|----------------------|--------------------|-------------------|
| | | Part No. | Part No. |
| 2 Form C | 1.5V DC | TXD2SA-1.5V-3-Z | TXD2SA-L-1.5V-3-Z |
| | 3V DC | TXD2SA-3V-3-Z | TXD2SA-L-3V-3-Z |
| | 4.5V DC | TXD2SA-4.5V-3-Z | TXD2SA-L-4.5V-3-Z |
| | 5V DC | TXD2SA-5V-3-Z | TXD2SA-L-5V-3-Z |
| | 6V DC | TXD2SA-6V-3-Z | TXD2SA-L-6V-3-Z |
| | 9V DC | TXD2SA-9V-3-Z | TXD2SA-L-9V-3-Z |
| | 12V DC | TXD2SA-12V-3-Z | TXD2SA-L-12V-3-Z |
| | 24V DC | TXD2SA-24V-3-Z | TXD2SA-L-24V-3-Z |

*Only for SA type.

Standard packing: Tape and reel: 500 pcs.; Case: 1,000 pcs.

Notes: 1. Tape and reel packing symbol "-Z" is not marked on the relay. "X" type tape and reel packing (picked from 1/3/4/5-pin side) is also available.



2. Please add "-4" to the part number for AgPd contacts (low level load). (Ex. TXD2SA-1.5V-4-Z)

RATING



1. Coil data

[Standard (B.B.M.) type]

1) Single side stable

| Nominal coil voltage | Pick-up voltage (at 20°C 68°F) | Drop-out voltage (at 20°C 68°F) | Nominal operating current [±10%] (at 20°C 68°F) | | Coil resistance [±10%] (at 20°C 68°F) | | Nominal operating power | | Max. applied voltage (at 20°C 68°F) |
|----------------------|---|---|--|--|--|--|--|--|--|
| | | | Surge breakdown voltage: 2,500V/6,000 V |  Surge breakdown voltage: 6,000 V (High breakdown voltage) | Surge breakdown voltage: 2,500V/6,000 V |  Surge breakdown voltage: 6,000 V (High breakdown voltage) | Surge breakdown voltage: 2,500V/6,000 V |  Surge breakdown voltage: 6,000 V (High breakdown voltage) | |
| 1.5V DC | 75%V or less of nominal voltage* (Initial) | 10%V or more of nominal voltage* (Initial) | 132.7mA | 187.5mA | 11Ω | 8Ω | 200mW | 280mW | 120%V of nominal voltage |
| 3V DC | | | 66.7mA | 93.5mA | 45Ω | 32Ω | | | |
| 4.5V DC | | | 44.4mA | 62.5mA | 101Ω | 72Ω | | | |
| 5V DC | | | 40.0mA | 56.2mA | 125Ω | 89Ω | | | |
| 6V DC | | | 33.3mA | 46.5mA | 180Ω | 129Ω | | | |
| 9V DC | | | 22.2mA | 31.1mA | 405Ω | 289Ω | | | |
| 12V DC | | | 16.7mA | 23.3mA | 720Ω | 514Ω | | | |
| 24V DC | | | 9.6mA | 12.9mA | 2,504Ω | 1,858Ω | | | |

2) 1 coil latching

| Nominal coil voltage | Set voltage (at 20°C 68°F) | Reset voltage (at 20°C 68°F) | Nominal operating current [±10%] (at 20°C 68°F) | | Coil resistance [±10%] (at 20°C 68°F) | | Nominal operating power | | Max. applied voltage (at 20°C 68°F) |
|----------------------|---|---|--|--|--|--|--|--|--|
| | | | Surge breakdown voltage: 2,500V/6,000 V |  Surge breakdown voltage: 6,000 V (High breakdown voltage) | Surge breakdown voltage: 2,500V/6,000 V |  Surge breakdown voltage: 6,000 V (High breakdown voltage) | Surge breakdown voltage: 2,500V/6,000 V |  Surge breakdown voltage: 6,000 V (High breakdown voltage) | |
| 1.5V DC | 75%V or less of nominal voltage* (Initial) | 75%V or less of nominal voltage* (Initial) | 100.0mA | 153.1mA | 15Ω | 10Ω | 150mW | 230mW | 120%V of nominal voltage |
| 3V DC | | | 50.0mA | 76.9mA | 60Ω | 39Ω | | | |
| 4.5V DC | | | 33.3mA | 51.1mA | 135Ω | 88Ω | | | |
| 5V DC | | | 30.0mA | 46.3mA | 166Ω | 109Ω | | | |
| 6V DC | | | 25.0mA | 38.5mA | 240Ω | 156Ω | | | |
| 9V DC | | | 16.7mA | 25.6mA | 540Ω | 352Ω | | | |
| 12V DC | | | 12.5mA | 19.2mA | 960Ω | 626Ω | | | |
| 24V DC | | | 7.1mA | 10.4mA | 3,388Ω | 2,304Ω | | | |



[M.B.B. type]

| Nominal coil voltage | Pick-up voltage (at 20°C 68°F) | Drop-out voltage (at 20°C 68°F) | Nominal operating current [±10%] (at 20°C 68°F) | Coil resistance [±10%] (at 20°C 68°F) | Nominal operating power | Max. applied voltage (at 20°C 68°F) |
|----------------------|--|--|--|--|-------------------------|--|
| 1.5V DC | 75%V or less of nominal voltage* (Initial) | 10%V or more of nominal voltage* (Initial) | 166.7mA | 9Ω | 250mW | 120%V of nominal voltage |
| 3V DC | | | 83.3mA | 36Ω | | |
| 4.5V DC | | | 55.6mA | 81Ω | | |
| 5V DC | | | 50.0mA | 100Ω | | |
| 6V DC | | | 41.7mA | 144Ω | | |
| 9V DC | | | 27.8mA | 324Ω | | |
| 12V DC | | | 20.8mA | 576Ω | | |
| 24V DC | | | 11.3mA | 2,133Ω | | |

*Pulse drive (JIS C 5442-1986)

*Only for surge breakdown voltage of 2,500 V.

2. Specifications

| Characteristics | Item | Specification | | |
|--|---|--|--|--|
| Contact | Arrangement | 2 Form C | 2 Form D (M.B.B.type)*1 | |
| | Contact resistance (Initial) | Max. 100 mΩ (By voltage drop 6 V DC 1A) | | |
| | Contact material | Standard contact: Ag+Au clad, AgPd contact (low level load): AgPd+Au clad (stationary), AgPd (movable) | | |
| Rating | Nominal switching capacity | Standard contact: 2 A 30 V DC, AgPd contact: 1 A 30 V DC (resistive load) | 1 A 30 V DC (resistive load) | |
| | Max. switching power | Standard contact: 60 W (DC), AgPd contact: 30 W (DC) (resistive load) | 30 W (DC) (resistive load) | |
| | Max. switching voltage | 220 V DC | 110 V DC | |
| | Max. switching current | Standard contact: 2 A, AgPd contact: 1 A | 1 A | |
| | Min. switching capacity (Reference value)*2 | 10μA10mV DC | | |
| | Nominal operating power | Single side stable | Surge breakdown voltage 2,500 V and 6,000 V types:  200mW (1.5 to 12 V DC), 230mW (24 V DC) Surge breakdown voltage 6,000 V (High breakdown voltage) type: 280mW (1.5 to 12 V DC), 310mW (24 V DC) | 250mW (1.5 to 12 V DC), 270mW (24 V DC) |
| | 1 coil latching | Surge breakdown voltage 2,500 V and 6,000 V types:  150mW (1.5 to 12 V DC), 170mW (24 V DC) Surge breakdown voltage 6,000 V (High breakdown voltage) type: 230mW (1.5 to 12 V DC), 250mW (24 V DC) | — | |
| Electrical characteristics | Insulation resistance (Initial) | Min. 1,000MΩ (at 500V DC) Measurement at same location as "Initial breakdown voltage" section. | | |
| | Breakdown voltage (Initial) | Between open contacts | Surge breakdown voltage 2,500 V and 6,000 V types:  1,000 Vrms for 1min. (Detection current: 10mA) Surge breakdown voltage 6,000 V (High breakdown voltage) type: 1,500 Vrms for 1min. (Detection current: 10mA) | 500 Vrms for 1min. (Detection current: 10mA) |
| | | Between contact and coil | Surge breakdown voltage 2,500 V type: 2,000 Vrms for 1min. (Detection current: 10mA) Surge breakdown voltage 6,000 V and 6,000 V (High breakdown voltage) types: 3,000 Vrms for 1min. (Detection current: 10mA) | 2,000 Vrms for 1min. (Detection current: 10mA) |
| | | Between contact sets | 1,000 Vrms for 1min. (Detection current: 10mA) | |
| | Surge breakdown voltage (Initial) | Between open contacts | 1,500 V (10×160μs) (FCC Part 68) | |
| | | Between contacts and coil*1 | Surge breakdown voltage 2,500 V type: 2,500 V, 2 × 10μs (Telcordia) Surge breakdown voltage 6,000 V and 6,000 V (High breakdown voltage) types: 6,000 V, 1.2 × 50μs | 2,500 V, 2 × 10μs (Telcordia) |
| | Temperature rise (at 20°C 68°F) | Max. 50°C 122°F (By resistive method, nominal coil voltage applied to the coil; contact carrying current: 2A [1A: M.B.B.]) | | |
| Operate time [Set time] (at 20°C 68°F) | Max. 4 ms [Max. 4 ms] (Nominal coil voltage applied to the coil, excluding contact bounce time.) | | | |
| Release time [Reset time] (at 20°C 68°F) | Max. 4 ms [Max. 4 ms] (Nominal coil voltage applied to the coil, excluding contact bounce time.) (without diode) | | | |
| Mechanical characteristics | Shock resistance | Functional | Min. 750 m/s ² (Half-wave pulse of sine wave: 6 ms; detection time: 10μs.) | Min. 500 m/s ² (Half-wave pulse of sine wave: 11 ms; detection time: 10μs.) |
| | | Destructive | Min. 1,000 m/s ² {100G} (Half-wave pulse of sine wave: 6 ms.) | |
| | Vibration resistance | Functional | 10 to 55 Hz at double amplitude of 3.3 mm (Detection time: 10μs.) | |
| | | Destructive | 10 to 55 Hz at double amplitude of 5 mm | |
| Expected life | Mechanical | Min. 10 ⁸ (at 180 cpm) | Min. 10 ⁷ (at 180 cpm) | |
| | Electrical | Min. 10 ⁵ (2 A 30 V DC resistive), Min. 5×10 ⁵ (1 A 30 V DC resistive) (at 20 cpm) | Min. 10 ⁵ (1 A 30 V DC resistive) (at 20 cpm) | |
| Conditions | Conditions for operation, transport and storage*3 | Ambient temperature: -40°C to +85°C -40°F to +185°F; Humidity: 5 to 85% R.H. (Not freezing and condensing at low temperature) | | |
| | Max. operating speed (at rated load) | 20 cpm | | |
| Unit weight | Approx. 2 g .071 oz | | | |

Notes: *1 M.B.B. type models are only available in 2,500 V surge breakdown voltage type.

*2 This value can change due to the switching frequency, environmental conditions, and desired reliability level, therefore it is recommended to check this with the actual load. (AgPd contact type is available for low level load switching [10V DC, 10mA max. level])

*3 The upper operation ambient temperature limit is the maximum temperature that can satisfy the coil temperature rise value. Refer to [6] AMBIENT ENVIRONMENT in GENERAL APPLICATION GUIDELINES (Page 24).

REFERENCE DATA

1. Maximum switching capacity

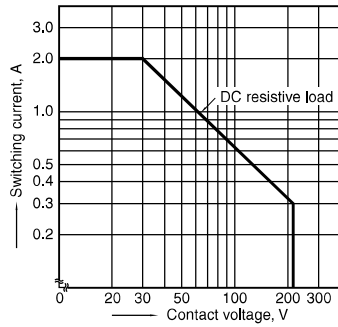

2. Life curve

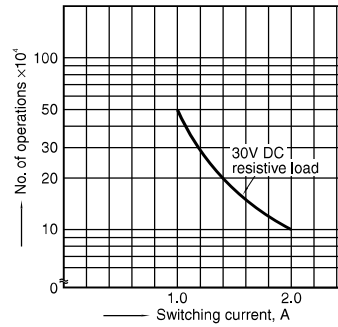

3. Mechanical life

Tested sample: TXD2-5V, 10 pcs.
Operating speed: 180 cpm

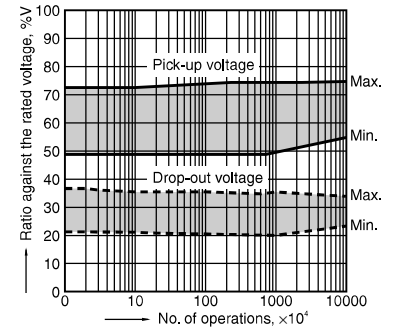

4. Electrical life (2 A 30 V DC resistive load)

Tested sample: TXD2-5V, 6 pcs.
Operating speed: 20 cpm

Change of pick-up and drop-out voltage

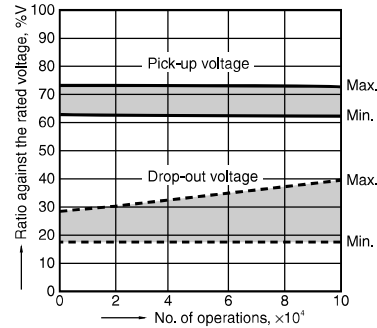

Change of contact resistance

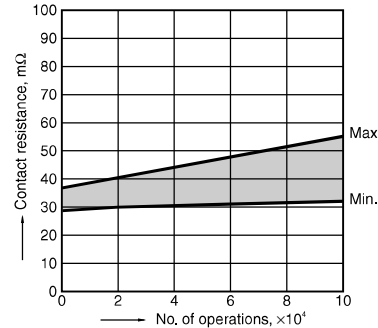

5-(1). Coil temperature rise

Tested sample: TXD2-5V, 6 pcs.
Measured portion: Inside the coil
Ambient temperature: 25°C 77°F, 70°C 158°F

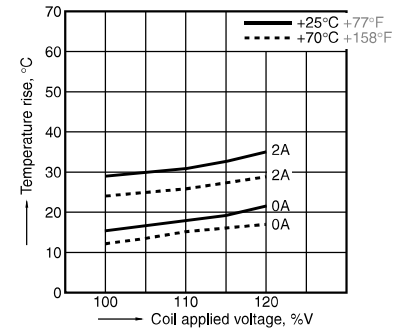

5-(2). Coil temperature rise

Tested sample: TXD2-24V, 6 pcs.
Measured portion: Inside the coil
Ambient temperature: 25°C 77°F, 70°C 158°F

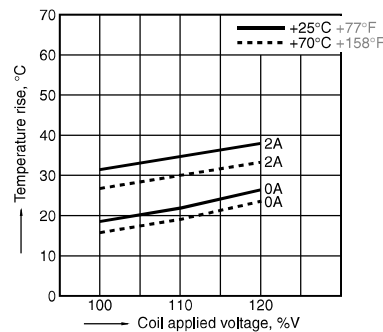

6-(1). Operate/release time characteristics (with diode)

Tested sample: TXD2-5V, 10 pcs.

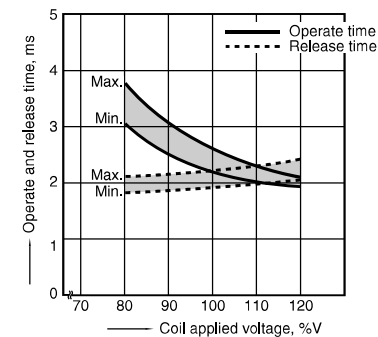

6-(2). Operate/release time characteristics (without diode)

Tested sample: TXD2-5V, 10 pcs.

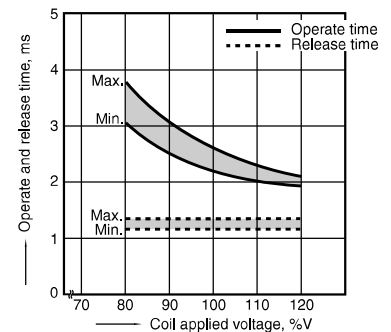

7. Ambient temperature characteristics

Tested sample: TXD2-5V, 5 pcs.

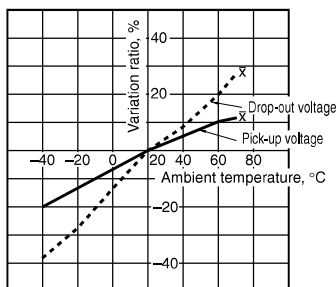

8. High-frequency characteristics (Isolation)

Tested sample: TXD2-12V, 2 pcs.

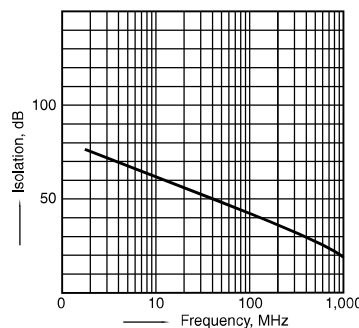

9. High-frequency characteristics (Insertion loss)

Tested sample: TXD2-12V, 2 pcs.

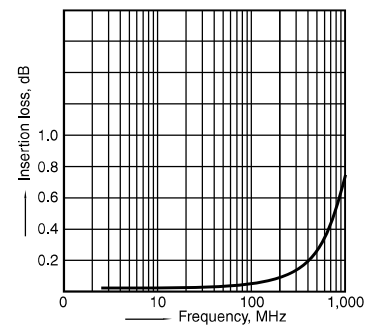

10. Malfunctional shock (single side stable)
 Tested sample: TXD2-5V, 6 pcs

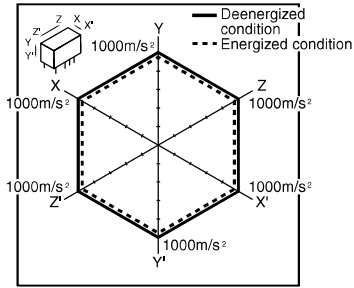

11-(1). Influence of adjacent mountin
 Tested sample: TXD2-12V, 6 pcs.

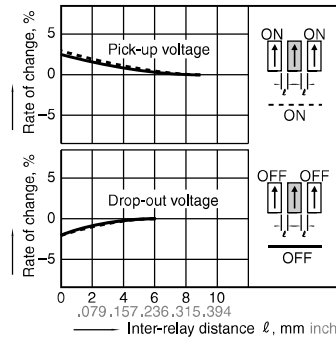

11-(2). Influence of adjacent mountin
 Tested sample: TXD2-12V, 6 pcs.

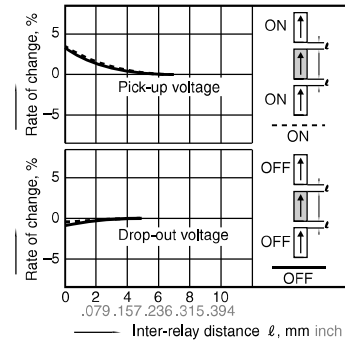

12. Actual load test (35 mA 48V DC wire spring relay load)
 Tested sample: TXD2-5V, 6 pcs.

Circuit

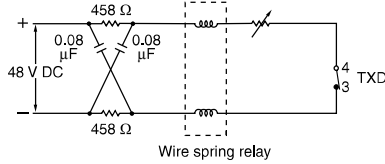

Change of pick-up and drop-out voltage

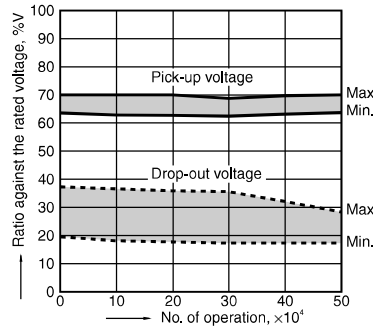

Change of contact resistance

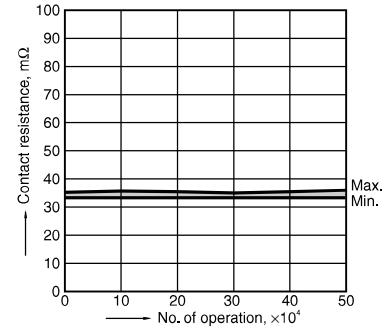

13-(1). Distribution of M.B.B. time
 Tested sample: TXD2-2M-5V, 50 pcs.
 Terminal No. 3-4-5: ON

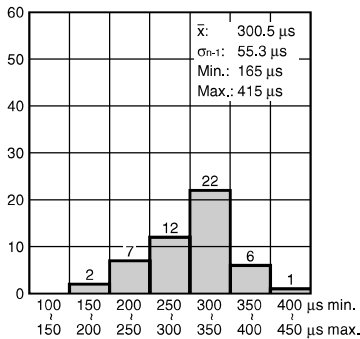

Terminal No. 3-4-5: OFF

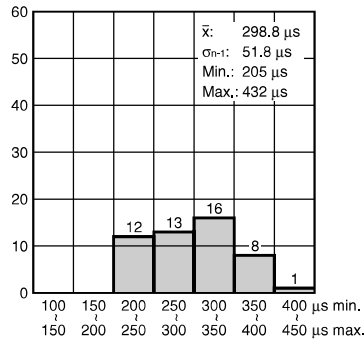

13-(2). Distribution of M.B.B. time
 Tested sample: TXD2-2M-5V, 50 pcs.
 Terminal No. 8-9-10: ON

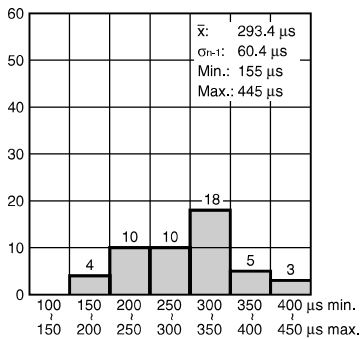

Terminal No. 8-9-10: OFF

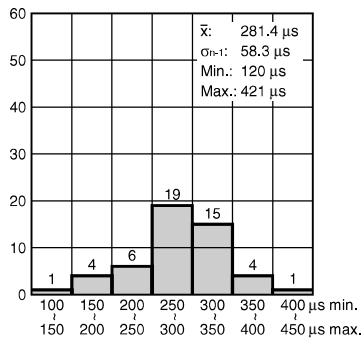

14. Surge breakdown voltage test
 Tested sample: TXD2-3V-6, 30 pcs.

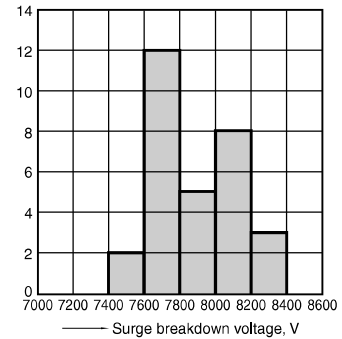

DIMENSIONS (mm inch)

The CAD data of the products with a **CAD Data** mark can be downloaded from: <http://industrial.panasonic.com/ac/e>

1. Surge breakdown voltage 2,500 V and 6,000 V types **!**

1) Standard PC board terminal

CAD Data



2,500 V type

External dimensions
Standard PC board terminal

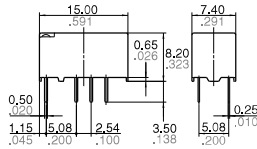

PC board pattern
(Bottom view)

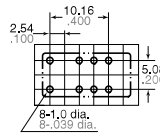

Tolerance: $\pm 0.1 \pm 0.04$

Schematic (Bottom view)
Single side stable 1 coil latching

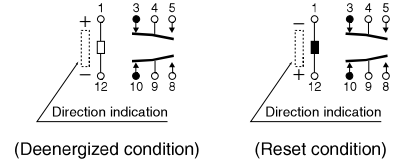

!

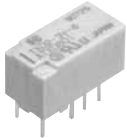

6,000 V type

2) Surface-mount terminal

CAD Data



| Type | External dimensions (General tolerance: $\pm 0.3 \pm 0.12$) | Suggested mounting pad (Top view) (Tolerance: $\pm 0.1 \pm 0.04$) |
|---------|--|--|
| | Single side stable and 1 coil latching | |
| SA type | | |
| SS type | | |

Schematic (Top view)

Single side stable

1 coil latching

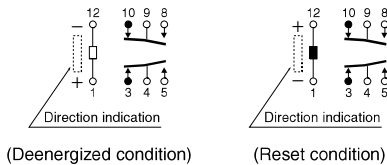

! 2. Surge breakdown voltage 6,000 V (High breakdown voltage type)

1) Standard PC board terminal

CAD Data

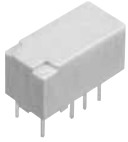

External dimensions
Standard PC board terminal

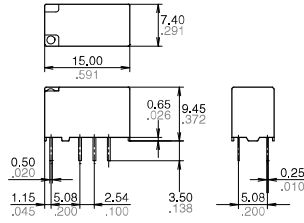

General tolerance: $\pm 0.3 \pm 0.12$

PC board pattern
(Bottom view)

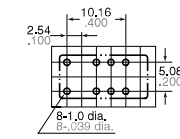

Tolerance: $\pm 0.1 \pm 0.04$

Schematic (Bottom view)

Single side stable

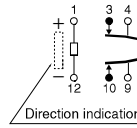

(Deenergized condition)

1 coil latching

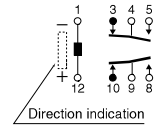

(Reset condition)

2) Surface-mount terminal

CAD Data



| Type | External dimensions (General tolerance: $\pm 0.3 \pm 0.12$) | Suggested mounting pad (Top view) (Tolerance: $\pm 0.1 \pm 0.04$) |
|---------|--|--|
| | Single side stable and 1 coil latching | Single side stable and 1 coil latching |
| SA type | | |
| SS type | | |

Schematic (Top view)

Single side stable

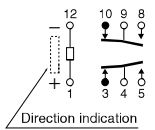

(Deenergized condition)

1 coil latching

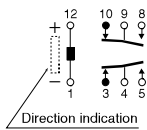

(Reset condition)

NOTES

1. Packing style

1) Tube packing

The relay is packed in a tube with the relay orientation mark on the left side, as shown in the figure below.

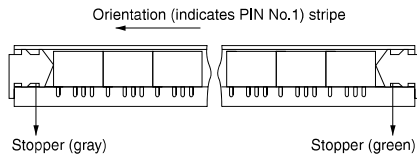

2) Tape and reel packing (surface-mount terminal type)

(1) Tape dimensions

(i) SA type

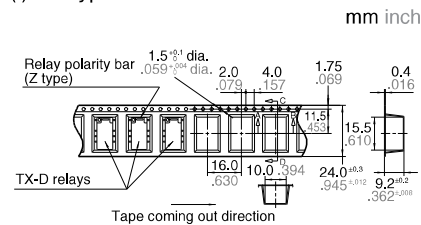

(ii) SS type

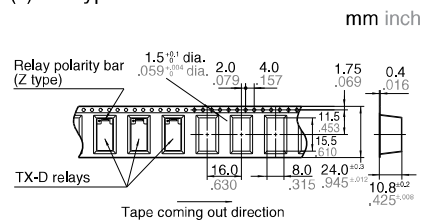

(2) Dimensions of plastic reel

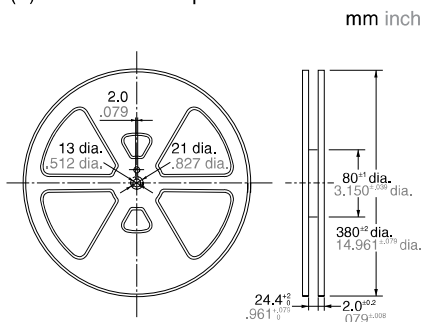

3) Ambient temperature when transporting and during storage with the product in its original packaging:
-40 to +70°C -40 to +158°F

2. Automatic insertion

To maintain the internal function of the relay, the chucking pressure should not exceed the values below.

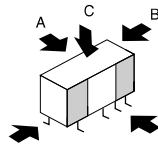

Chucking pressure in the direction A:

4.9 N {500gf} or less

Chucking pressure in the direction B:

9.8 N {1 kgf} or less

Chucking pressure in the direction C:

9.8 N {1 kgf} or less

Please chuck the portion.

Avoid chucking the center of the relay. In addition, excessive chucking pressure to the pinpoint of the relay should be avoided.

3. M.B.B. type

A small OFF time may be generated by the contact bounce during contact switching. Check the actual circuit carefully.

If the relay is dropped accidentally, check the appearance and characteristics including M.B.B. time before use.

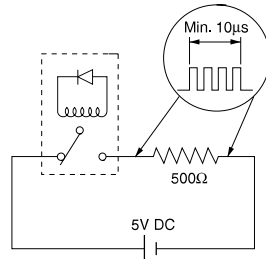

Measuring condition of M.B.B. time

For general cautions for use, please refer to the "Cautions for use of Signal Relays" or "General Application Guidelines".

单击下面可查看定价，库存，交付和生命周期等信息

[>>Panasonic\(松下\)](#)