

UNR4221/4222/4223/4224

(UN4221/4222/4223/4224)

Silicon NPN epitaxial planar type

For digital circuits

■ Features

- Costs can be reduced through downsizing of the equipment and reduction of the number of parts
- New S type package, allowing supply with the radial taping

■ Resistance by Part Number

	(R ₁)	(R ₂)
• UNR4221 (UN4221)	2.2 kΩ	2.2 kΩ
• UNR4222 (UN4222)	4.7 kΩ	4.7 kΩ
• UNR4223 (UN4223)	10 kΩ	10 kΩ
• UNR4224 (UN4224)	2.2 kΩ	10 kΩ

■ Absolute Maximum Ratings T_a = 25°C

Parameter	Symbol	Rating	Unit
Collector-base voltage (Emitter open)	V _{CB0}	50	V
Collector-emitter voltage (Base open)	V _{CEO}	50	V
Collector current	I _C	500	mA
Total power dissipation	P _T	300	mW
Junction temperature	T _J	150	°C
Storage temperature	T _{stg}	-55 to +150	°C

■ Electrical Characteristics T_a = 25°C ± 3°C

Parameter	Symbol	Conditions	Min	Typ	Max	Unit	
Collector-base voltage (Emitter open)	V _{CB0}	I _C = 10 μA, I _E = 0	50			V	
Collector-emitter voltage (Base open)	V _{CEO}	I _C = 2 mA, I _B = 0	50			V	
Collector-base cutoff current (Emitter open)	I _{CB0}	V _{CB} = 50 V, I _E = 0			1.0	μA	
Collector-emitter cutoff current (Base open)	I _{CEO}	V _{CE} = 50 V, I _B = 0			1.0	μA	
Emitter-base cutoff current (Collector open)	UNR4221	I _{EBO}			5.0	mA	
	UNR4222						2.0
	UNR4223/4224						1.0
Forward current transfer ratio	UNR4221	h _{FE}	V _{CE} = 10 V, I _C = 100 mA	40		—	
	UNR4222			50			
	UNR4223/4224			60			
Collector-emitter saturation voltage	V _{CE(sat)}	I _C = 100 mA, I _B = 5 mA			0.25	V	
Output voltage high-level	V _{OH}	V _{CC} = 5 V, V _B = 0.5 V, R _L = 500 Ω	4.9			V	
Output voltage low-level	V _{OL}	V _{CC} = 5 V, V _B = 3.5 V, R _L = 500 Ω			0.2	V	

Note) The part numbers in the parenthesis show conventional part number.

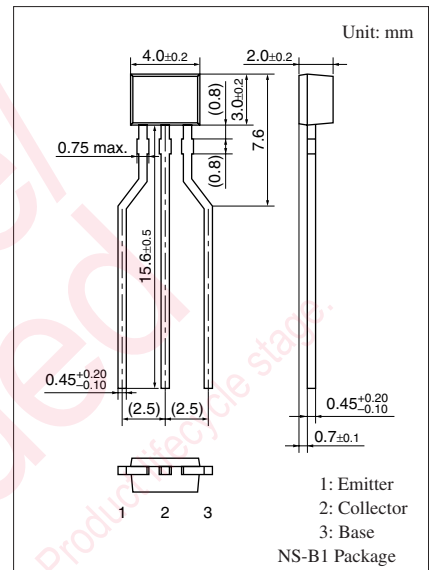

Internal Connection

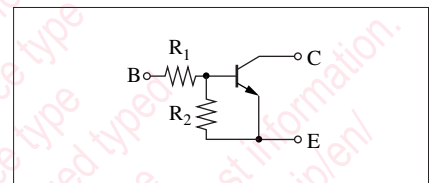

■ Electrical Characteristics (continued) $T_a = 25^\circ\text{C} \pm 3^\circ\text{C}$

Parameter	Symbol	Conditions	Min	Typ	Max	Unit
Transition frequency	f_T	$V_{CB} = 10\text{ V}, I_E = -50\text{ mA}, f = 200\text{ MHz}$		200		MHz
Input resistance	UNR4221/4224 UNR4222 UNR4223	R_1	-30%	2.2	+30%	k Ω
				4.7		
				10		
Resistance ratio	UNR4224	R_1/R_2	0.8	1.0	1.2	
			0.17	0.22	0.27	

Note) Measuring methods are based on JAPANESE INDUSTRIAL STANDARD JIS C 7030 measuring methods for transistors.

Common characteristics chart

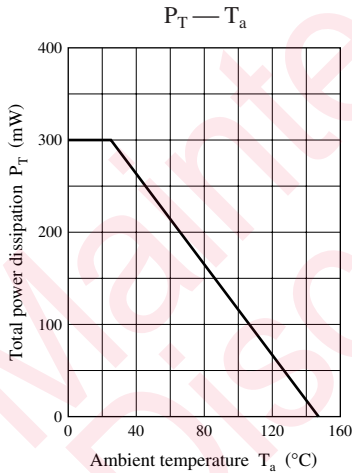

Characteristics charts of UNR4221

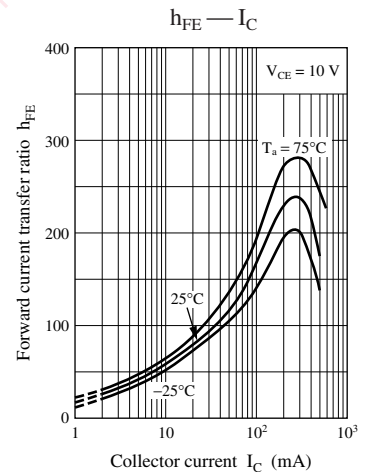
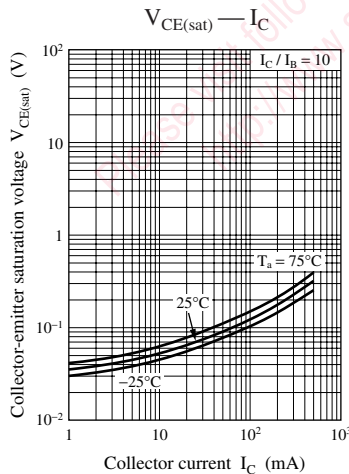
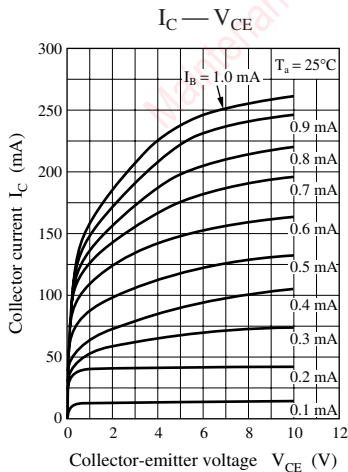

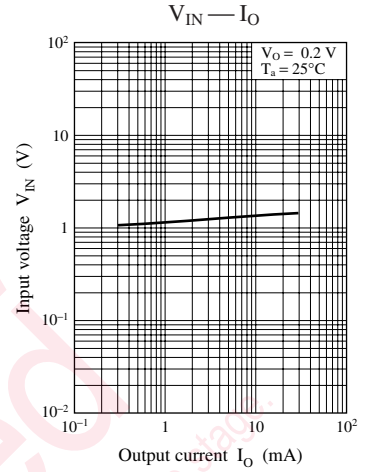
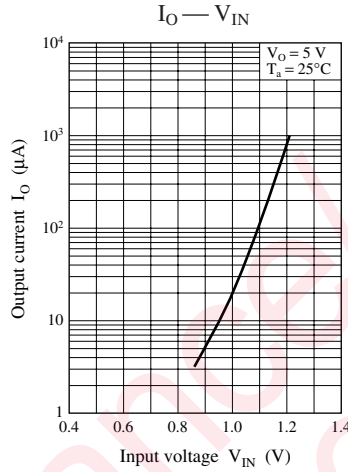
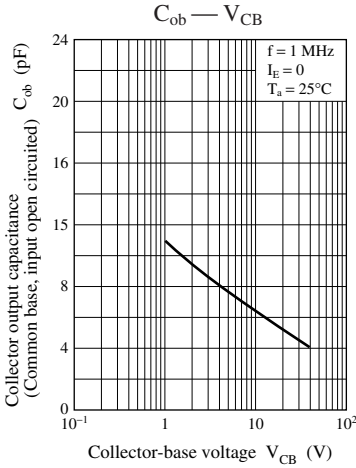

Characteristics charts of UNR4222

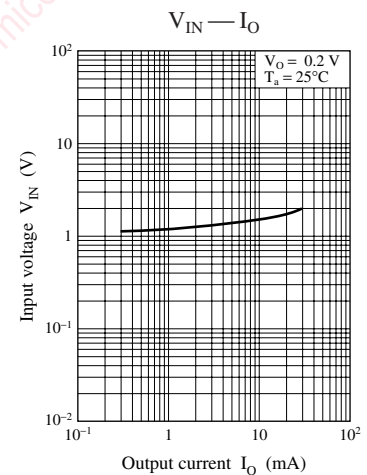
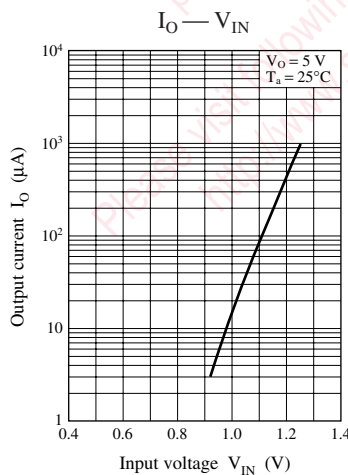
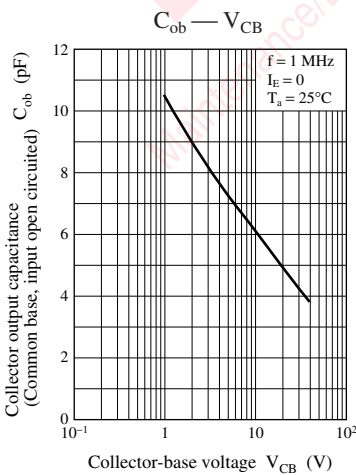
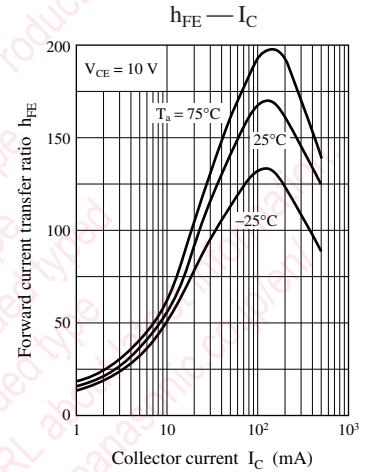
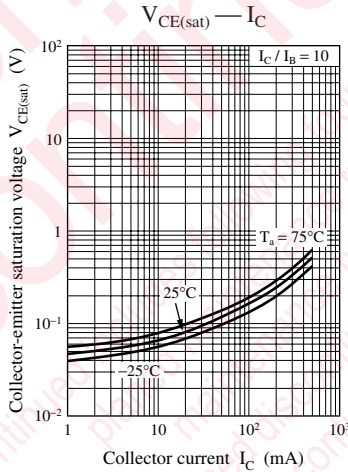
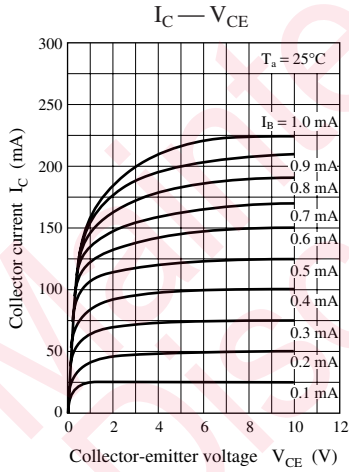

Characteristics charts of UNR4223

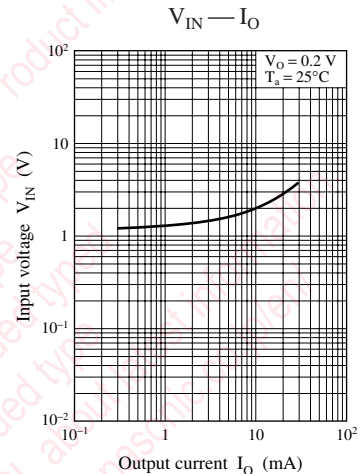
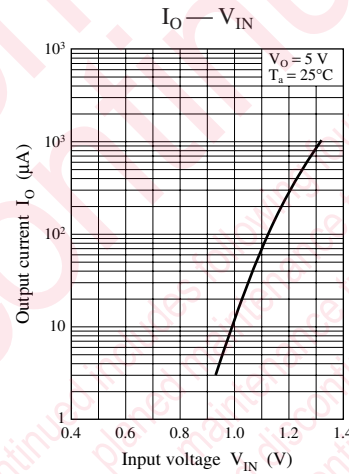
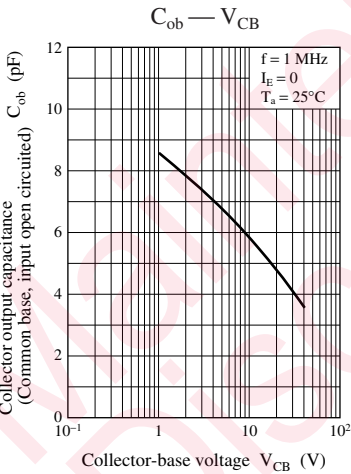
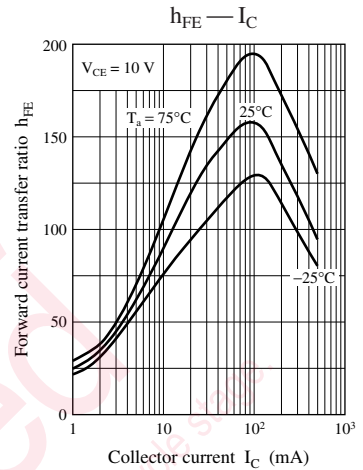
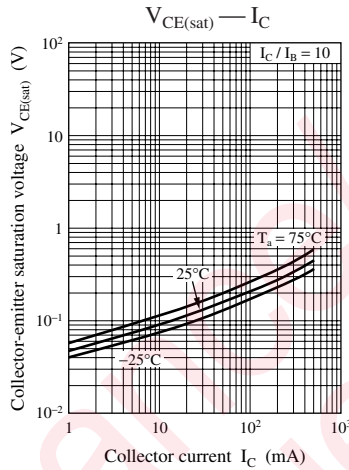
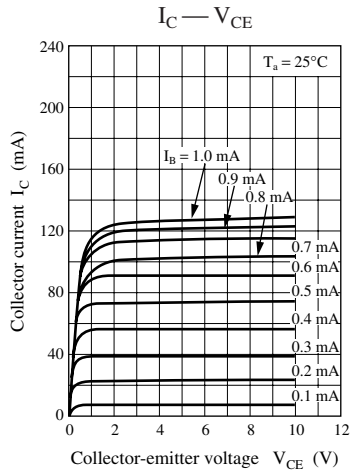

Characteristics charts of UNR4224

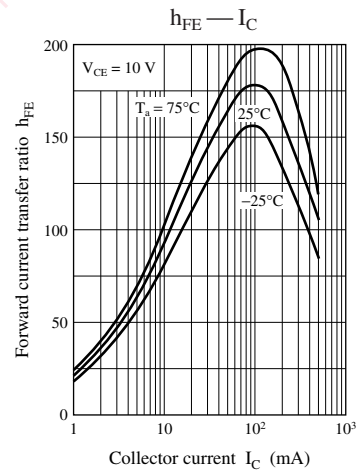
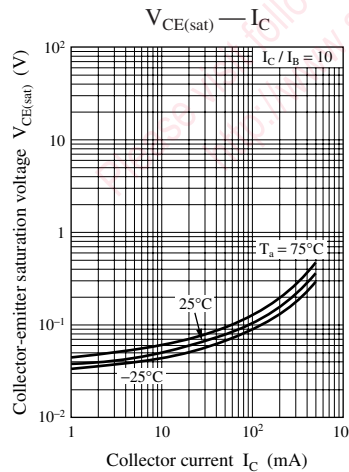
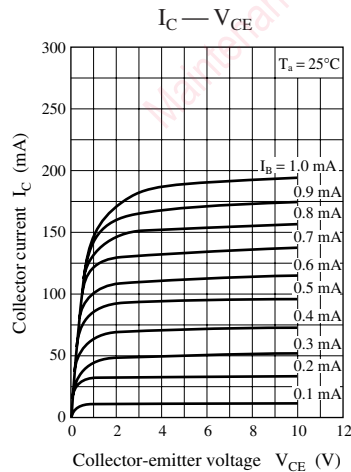

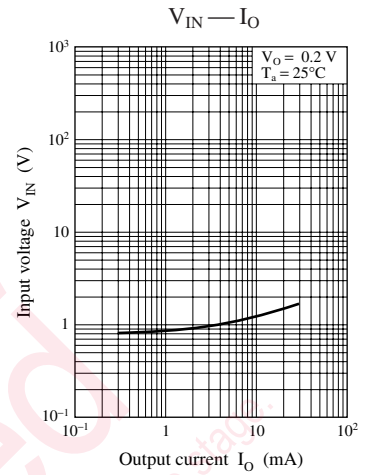
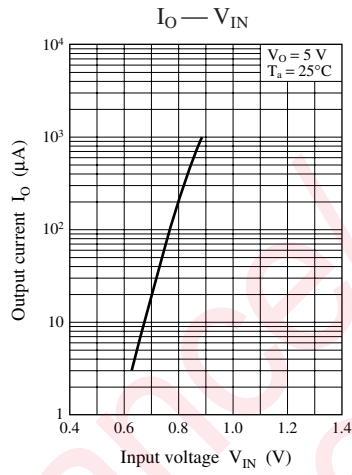
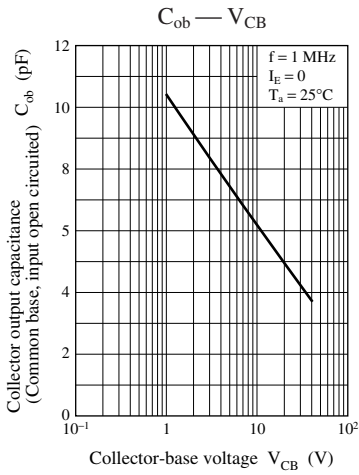

Maintenance/Discontinued includes following four Product lifecycle stages:
planned maintenance type
maintenance type
planned discontinued type
discontinued type
Please visit following URL about latest information.
<http://www.semicon.panasonic.co.jp/en/>

Request for your special attention and precautions in using the technical information and semiconductors described in this book

- (1) If any of the products or technical information described in this book is to be exported or provided to non-residents, the laws and regulations of the exporting country, especially, those with regard to security export control, must be observed.
- (2) The technical information described in this book is intended only to show the main characteristics and application circuit examples of the products, and no license is granted under any intellectual property right or other right owned by our company or any other company. Therefore, no responsibility is assumed by our company as to the infringement upon any such right owned by any other company which may arise as a result of the use of technical information described in this book.
- (3) The products described in this book are intended to be used for standard applications or general electronic equipment (such as office equipment, communications equipment, measuring instruments and household appliances).
Consult our sales staff in advance for information on the following applications:
 - Special applications (such as for airplanes, aerospace, automobiles, traffic control equipment, combustion equipment, life support systems and safety devices) in which exceptional quality and reliability are required, or if the failure or malfunction of the products may directly jeopardize life or harm the human body.
 - Any applications other than the standard applications intended.
- (4) The products and product specifications described in this book are subject to change without notice for modification and/or improvement. At the final stage of your design, purchasing, or use of the products, therefore, ask for the most up-to-date Product Standards in advance to make sure that the latest specifications satisfy your requirements.
- (5) When designing your equipment, comply with the range of absolute maximum rating and the guaranteed operating conditions (operating power supply voltage and operating environment etc.). Especially, please be careful not to exceed the range of absolute maximum rating on the transient state, such as power-on, power-off and mode-switching. Otherwise, we will not be liable for any defect which may arise later in your equipment.
 - Even when the products are used within the guaranteed values, take into the consideration of incidence of break down and failure mode, possible to occur to semiconductor products. Measures on the systems such as redundant design, arresting the spread of fire or preventing glitch are recommended in order to prevent physical injury, fire, social damages, for example, by using the products.
- (6) Comply with the instructions for use in order to prevent breakdown and characteristics change due to external factors (ESD, EOS, thermal stress and mechanical stress) at the time of handling, mounting or at customer's process. When using products for which damp-proof packing is required, satisfy the conditions, such as shelf life and the elapsed time since first opening the packages.
- (7) This book may be not reprinted or reproduced whether wholly or partially, without the prior written permission of Matsushita Electric Industrial Co., Ltd.

单击下面可查看定价，库存，交付和生命周期等信息

[>>Panasonic\(松下\)](#)